

BM23PF Series

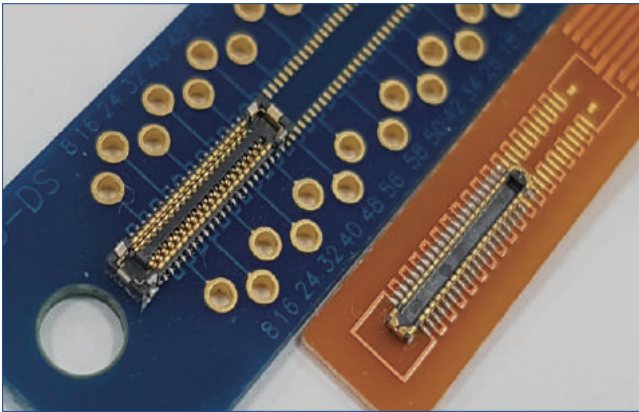

High current applicable

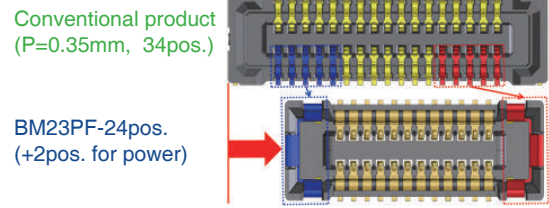

Power lines are concentrated into 2 power contacts (Up to 5A/line) instead of conventional multiple signal contacts.

Fig.1

Features

1. Rated current : 5A

Equipped with power contacts capable of handling up to 5A current. (See Fig.1)

- Rated current : 5A (Power contact), 0.3A (Signal contact)

2. Space saving design

Compact design ideal for mobile devices. (See Fig.2)

- Pitch : 0.35mm, Width : 1.98mm, Stacking height : 0.8mm

3. Robust [Breaking Strength : 90N]

Metal guides prevent housing damage due to incorrect mating. (See Fig.3)

4. Highly reliable contact design

2-point contact design for both power and signal contact ensures high reliability. (See Fig.4)

5. Good mating operation

Wide self alignment range with metal guides offers enhanced mating operation. (0.4mm in pitch direction, 0.35mm in width direction) Furthermore, a clear tactile click generated by the unique locking contact design insures complete mating.

6. Supports USB 3.1 Gen.2 (10Gbps) transmission

Signal contacts support USB3.1 Gen.2 transmission speed.

Space-saving

Dimension Example : 24 Pos.

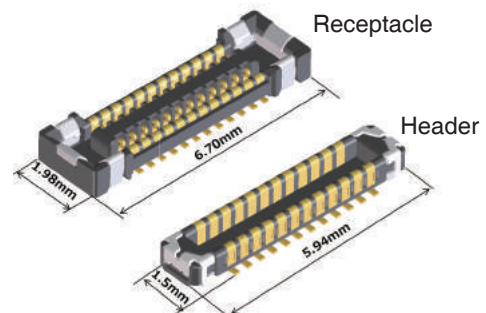

The narrower and shorter, yet flexible design allows tight installation (Pitch : 0.35mm, Width : 1.98mm)

Fig.2

Robust design

Metal guide prevents connector damage even if mated incorrectly.

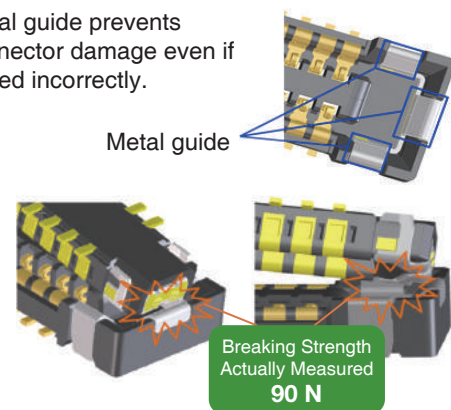

Fig.3

Environmental

- Halogen-free*
As defined by IEC 61249-2-21
Br : 900ppm max., Cl : 900ppm max.
Br+Cl : 1,500ppm max.

Cross-sectional view of mated contacts

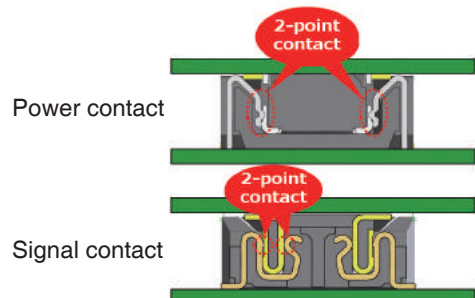

Fig.4

Product Specifications

Ratings	Rated current	Signal contact : 0.3A (Note1) Power contact : 5A	Operating temperature range	-55°C to 85°C (Note2)	Storage temperature range	-10°C to 60°C (Note3)
	Rated voltage	30V AC/DC	Operating humidity range	20% to 80%	Storage humidity range	40% to 70% (Note3)

Items	Specifications	Conditions
1. Contact resistance	Signal contact : 90mΩ max. Power contact : 30mΩ max.	Measured at 20mV AC, 1kHz, and 1mA
2. Insulation resistance	50MΩ min.	Measured at 100V DC
3. Withstanding voltage	No flashover or insulation breakdown	100V AC for 1 minute
4. Durability	Contact resistance : Signal contact : 90mΩ max. Power contact : 30mΩ max.	10 mating cycles
5. Vibration	No electrical discontinuity for more than 1μs.	Frequency: 10 to 55Hz, single amplitude : 0.75mm in 3 axis directions for 5 minutes, 10 cycles
6. Shock resistance	No electrical discontinuity of 1μs or more.	Acceleration : 490m/s ² , duration of pulse: 11ms at 3 times for 3 directions.
7. Humidity	Contact resistance : Signal contact : 90mΩ max. Power contact : 30mΩ max. Insulation resistance : 25MΩ min.	96 hours at temperature of 40±2°C and a humidity range from 90 to 95%
8. Temperature cycle	Contact resistance : Signal contact : 90mΩ max. Power contact : 30mΩ max. Insulation resistance : 50MΩ min.	-55°C for 30minutes → 85°C for 30minutes, 5 cycles
9. Soldering heat resistance	No dissolution or melting of the resin that will affect the performance.	Reflow : with recommended temperature profile; Hand soldering at soldering iron temperature of 350°C for 3 seconds max.

Note 1 : The total current capacity for the connector with 40 or more signal contacts is 12A for all contacts.(Signal contact only)

Note 2 : Includes temperature rise caused by current flow.

Note 3 : Storage refers to long-term-storage of unused items before they are mounted on the PCB.

Operating temperature/humidity range applies to the state of temporary storage such as non-powered after mounting on the PCB, and during transportation, etc.

Materials / Finish

Product	Part	Material	Finish	UL Regulation
Receptacle Header	Insulator	LCP	Black	UL94V-0
	Signal Contact	Copper alloy	Gold plating	—
	Power Contact	Copper alloy	Gold plating	—

Product Number Structure

Refer to the chart below when determining the product specifications from the product number.

Please select from the product numbers listed in this catalog when placing orders.

● Receptacle / Header

BM 23 PF 0.8 - * DS - 0.35 V (*)**

① ② ③ ④ ⑤ ⑥ ⑦ ⑧ ⑨

① Series Name: BM	⑥ Connector Type DS: Receptacle DP: Header
② Series No. : 23	⑦ Contact Pitch : 0.35mm
③ Shape Symbols PF: Power contact type	⑧ Terminal type V : Straight SMT
④ Stacking Height : 0.8mm	⑨ Gold plated specification and packaging status (51) : Gold plate thickness 0.05μm Embossed tape packaging(10,000pcs/reel) (895) : Gold plate thickness 0.05μm Embossed tape packaging (1,000pcs/reel)
⑤ Number of Contacts	

■ Receptacle

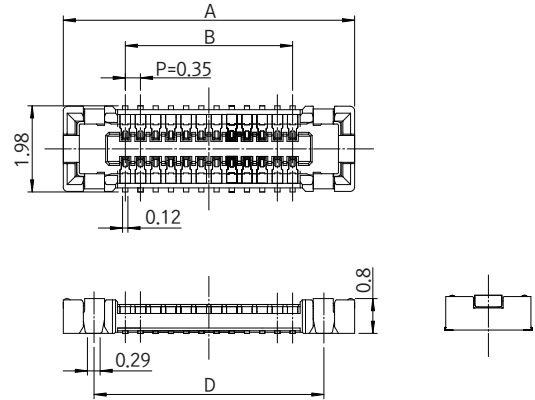
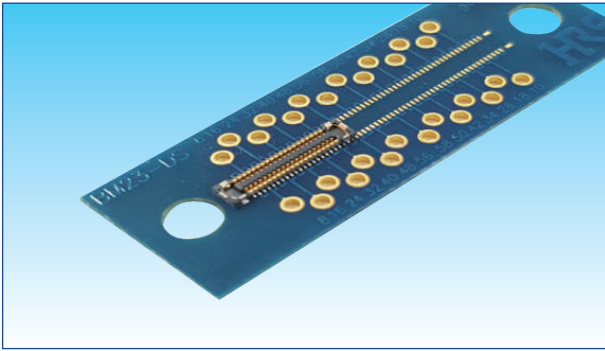

◆ Recommended PCB layout

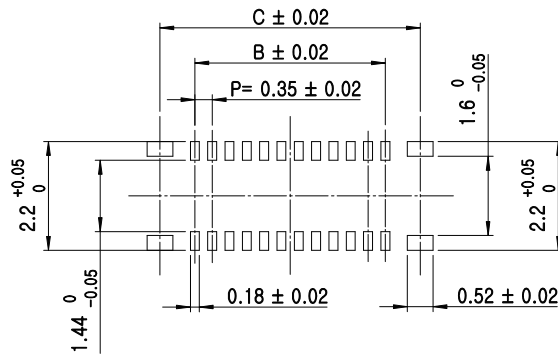

◆ Recommended metal mask dimensions (mask thickness : 100μm)

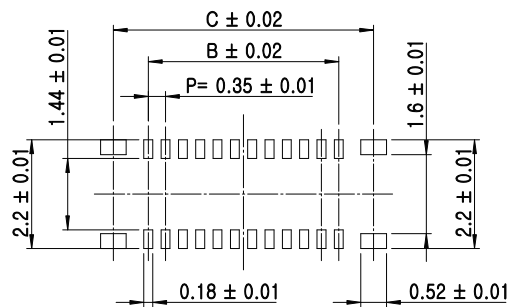

Unit : mm

Part No.	HRS No.	No. of contacts	A	B	C	D
BM23PF0.8-10DS-0.35V(***)	480-0312-0 **	10	4.25	1.40	2.81	2.84
BM23PF0.8-14DS-0.35V(***)	480-0367-0 **	14	4.95	2.10	3.51	3.54
BM23PF0.8-20DS-0.35V(***)	480-0434-0 **	20	6.00	3.15	4.56	4.59
BM23PF0.8-24DS-0.35V(***)	480-0368-0 **	24	6.70	3.85	5.26	5.29
BM23PF0.8-30DS-0.35V(***)	480-0472-0 **	30	7.75	4.90	6.31	6.34
BM23PF0.8-40DS-0.35V(***)	480-0369-0 **	40	9.50	6.65	8.06	8.09
BM23PF0.8-42DS-0.35V(***)	480-0436-0 **	42	9.85	7.00	8.41	8.44
BM23PF0.8-46DS-0.35V(***)	480-0402-0 **	46	10.55	7.70	9.11	9.14
BM23PF0.8-54DS-0.35V(***)	480-0370-0 **	54	11.95	9.10	10.51	10.54

Note 1 : Please place orders in full reel quantities.

Note 2 : This connector has no polarity.

Note 3 : The specification number(895) in the Part No. changes to(95) in the HRS No.

Header

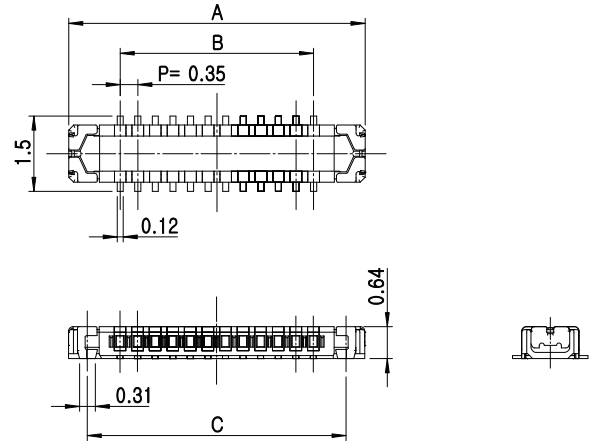
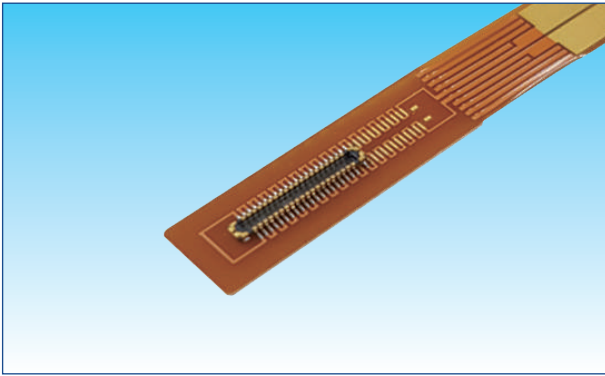

Recommended PCB layout

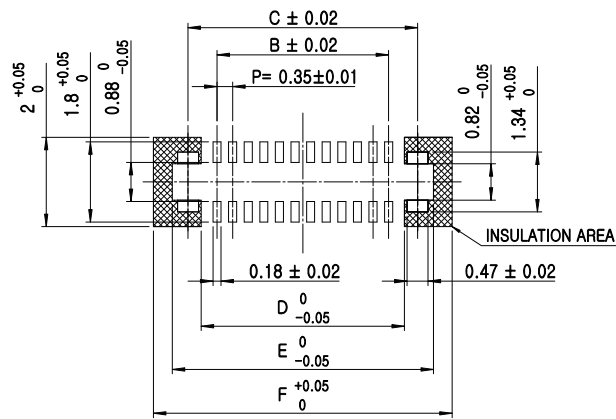

Recommended metal mask dimensions (mask thickness : 100µm)

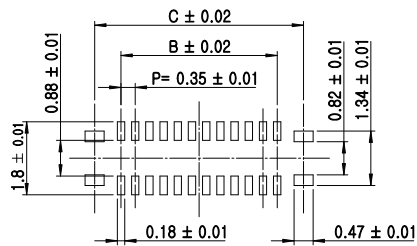

Unit : mm

Part No.	HRS No.	No. of contacts	A	B	C	D	E	F
BM23PF0.8-10DP-0.35V(***)	480-0306-0 **	10	3.49	1.40	2.70	2.11	3.41	4.25
BM23PF0.8-14DP-0.35V(***)	480-0366-0 **	14	4.19	2.10	3.40	2.81	4.11	4.95
BM23PF0.8-20DP-0.35V(***)	480-0433-0 **	20	5.24	3.15	4.45	3.86	5.16	6.00
BM23PF0.8-24DP-0.35V(***)	480-0291-0 **	24	5.94	3.85	5.15	4.56	5.86	6.70
BM23PF0.8-30DP-0.35V(***)	480-0426-0 **	30	6.99	4.90	6.20	5.61	6.91	7.75
BM23PF0.8-40DP-0.35V(***)	480-0317-0 **	40	8.74	6.65	7.95	7.36	8.66	9.50
BM23PF0.8-42DP-0.35V(***)	480-0435-0 **	42	9.09	7.00	8.30	7.71	9.01	9.85
BM23PF0.8-46DP-0.35V(***)	480-0401-0 **	46	9.79	7.70	9.00	8.41	9.71	10.55
BM23PF0.8-54DP-0.35V(***)	480-0303-0 **	54	11.19	9.10	10.40	9.81	11.11	11.95

Note 1 : Please place orders in full reel quantities.

Note 2 : This connector has no polarity.

Note 3 : The specification number(895) in the Part No. changes to(95) in the HRS No.

◆ Embossed Tape Dimensions (IEC 602286-3, with JIC C 0806)

● Receptacle

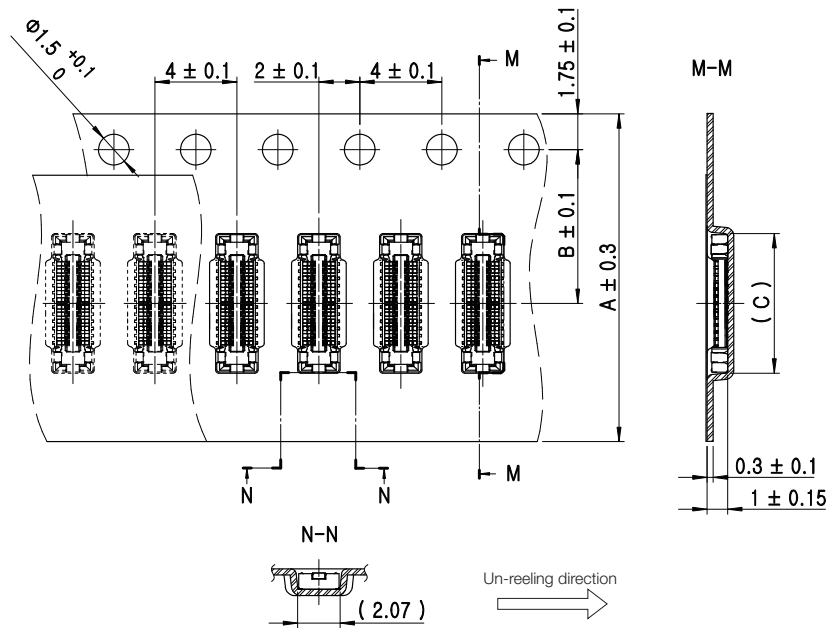

● Reel Dimensions

▶ 10,000pcs/reel

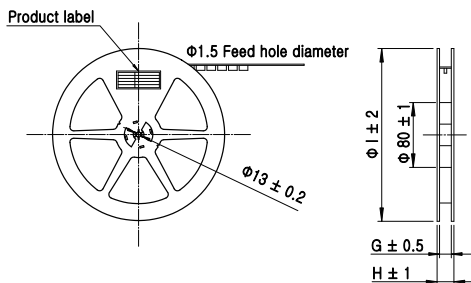

▶ 1,000pcs/reel

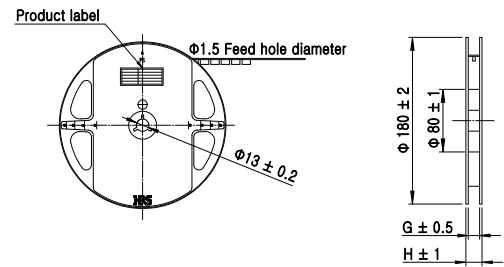

Unit : mm

Part No.	HRS No.	No. of contacts	A	B	C	G	H	I
BM23PF0.8-10DS-0.35V(***)	480-0312-0 **	10	16	7.5	4.36	17.5	21.5	330
BM23PF0.8-14DS-0.35V(***)	480-0367-0 **	14	16	7.5	5.06	17.5	21.5	330
BM23PF0.8-20DS-0.35V(***)	480-0434-0 **	20	16	7.5	6.11	17.5	21.5	330
BM23PF0.8-24DS-0.35V(***)	480-0368-0 **	24	16	7.5	6.81	17.5	21.5	330
BM23PF0.8-30DS-0.35V(***)	480-0472-0 **	30	16	7.5	7.86	17.5	21.5	330
BM23PF0.8-40DS-0.35V(***)	480-0369-0 **	40	24	11.5	9.61	25.5	29.5	330
BM23PF0.8-42DS-0.35V(***)	480-0436-0 **	42	24	11.5	9.96	25.5	29.5	330
BM23PF0.8-46DS-0.35V(***)	480-0402-0 **	46	24	11.5	10.66	25.5	29.5	330
BM23PF0.8-54DS-0.35V(***)	480-0370-0 **	54	24	11.5	12.06	25.5	29.5	330

Note 1 : The specification number(895) in the Part No. changes to(95) in the HRS No.

◆ Embossed Tape Dimensions (IEC 602286-3, with JIC C 0806)

● Header

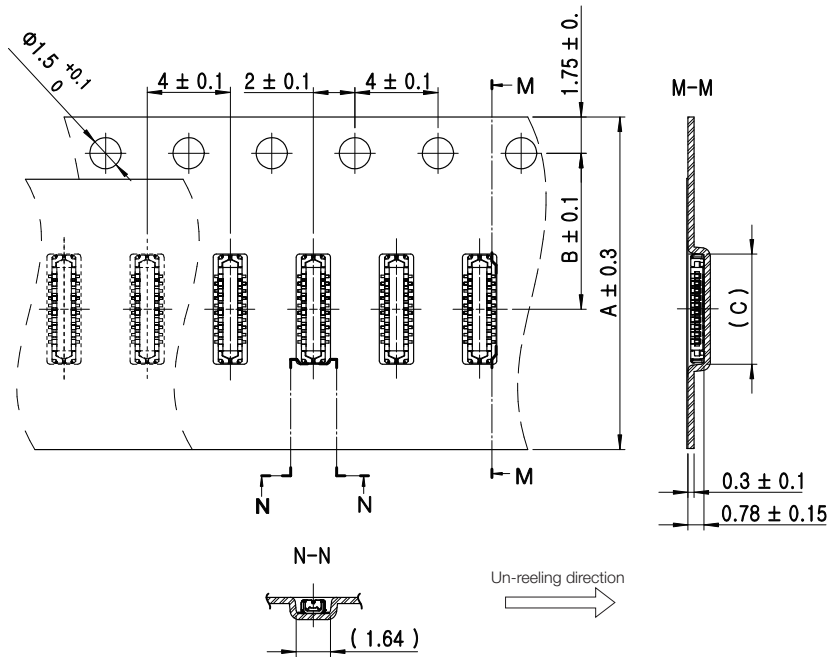

● Reel Dimensions

▶ 10,000pcs/reel

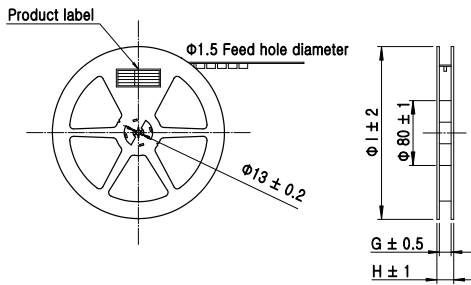

▶ 1,000pcs/reel

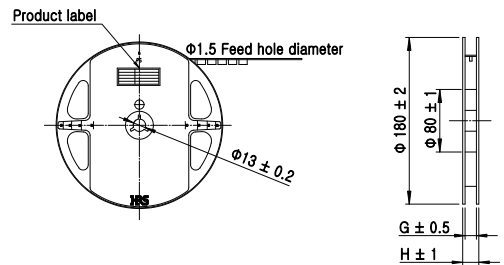

Unit : mm

Part No.	HRS No.	No. of contacts	A	B	C	G	H	I
BM23PF0.8-10DP-0.35V(***)	480-0306-0 **	10	12	5.5	3.65	13.5	17.5	330
BM23PF0.8-14DP-0.35V(***)	480-0366-0 **	14	16	7.5	4.35	17.5	21.5	330
BM23PF0.8-20DP-0.35V(***)	480-0433-0 **	20	16	7.5	5.4	17.5	21.5	330
BM23PF0.8-24DP-0.35V(***)	480-0291-0 **	24	16	7.5	6.10	17.5	21.5	330
BM23PF0.8-30DP-0.35V(***)	480-0426-0 **	30	16	7.5	7.15	17.5	21.5	330
BM23PF0.8-40DP-0.35V(***)	480-0317-0 **	40	24	11.5	8.90	25.5	29.5	330
BM23PF0.8-42DP-0.35V(***)	480-0435-0 **	42	24	11.5	9.25	25.5	29.5	330
BM23PF0.8-46DP-0.35V(***)	480-0401-0 **	46	24	11.5	9.95	25.5	29.5	330
BM23PF0.8-54DP-0.35V(***)	480-0303-0 **	54	24	11.5	11.35	25.5	29.5	330

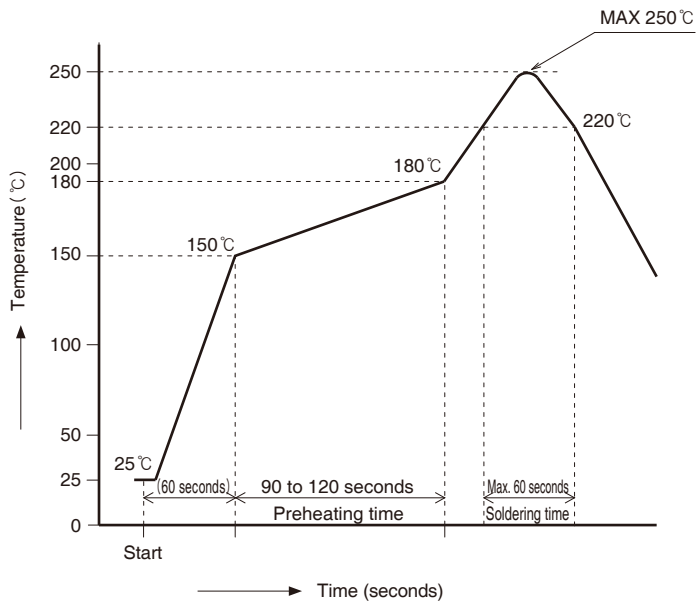

Note 1: The specification number(895) in the Part No. changes to(95) in the HRS No.

◆ Precautions

<p>1. Recommended solder temperature profile</p>	 <p>[Conditions]</p> <ol style="list-style-type: none"> 1. Peak temperature : Maximum of 250°C 2. Heat section : 220°C min., within 60 seconds 3. Preheat section : 150 to 180°C, 90 to 120 seconds 4. Number of reflow cycles : Maximum of 2 cycles <p>Note 1 : The temperature is the surface temperature of the PCB in the vicinity of the connector lead part. Note 2 : When using nitrogen reflow process, please mount the product with the oxygen concentration at a minimum of 1,000[ppm]. Please contact Hirose if the concentration is below 1,000[ppm]</p>
<p>2. Recommended manual soldering conditions</p>	<p>Soldering iron temperature: 340±10°C Soldering time : within 3 seconds</p>
<p>3. Recommended screen thickness and open area ratio to PCB pattern area</p>	<p>Thickness : 0.1mm Aperture ratio : 100% on the DS side, 100% on the DP side</p>
<p>4. Warpage of the PCB</p>	<p>A maximum of 0.02mm at the center part of the connector on both ends of the connector.</p>
<p>5. Cleaning</p>	<p>Not recommended. If this product is cleaned, please evaluate the performance before using it. Cleaning may cause a change in the mating/unmating properties as well as environmental resistance.</p>
<p>6. Notes</p>	<ul style="list-style-type: none"> ■ Care should be taken when mating/unmating the connector and when it is not mounted on the PCB. Damage or deformation of the contacts may occur. ■ Avoid supporting the PCB only with the connectors. Support it by other means such as bolts, screws, posts, etc. ■ Care should be taken to avoid excessive prying mating/unmating that could cause damage. ■ During manual soldering, do not apply flux which will cause flux oozing on connector. ■ This product may have slight color differences due to production lot variability, but this does not have any effect on the performance. ■ Please refer to the next page for precautions regarding mating/unmating. ■ Because the product can disengage if dropped (or other impact), and by FPC routing, it is advised to secure the mated connectors to the board with housings and cushioning materials. ■ Caution! Do not use the connector in non-recommended conditions (i.e., rated current, rated voltage, PCB design and operating environment, etc.). Such usage could lead to material outgassing, ignition, or short-circuit, etc. Refer to the specifications and the guidelines for board pattern dimensions, board cautions, and connector treatment. Please contact Hirose if using the connector under conditions other than those described in the specifications and the guidelines is being considered.

Apr. 1. 2025 Copyright 2025 HIROSE ELECTRIC CO., LTD. All Rights Reserved.

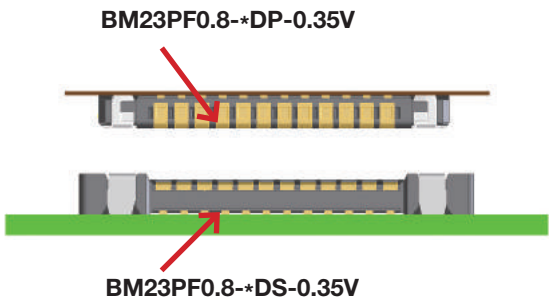
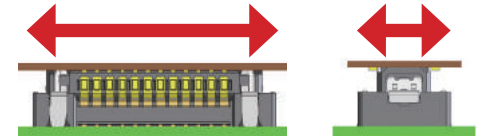
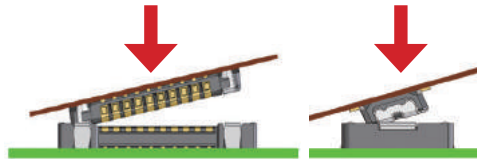
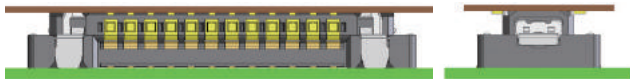
● Handle with care when mating a connector

 <p>BM23PF0.8-DP-0.35V</p> <p>BM23PF0.8-DS-0.35V</p>	
<p>Alignment method</p> <p>OK</p>  <p>NG</p> 	<p>When aligning, look for the guide port without applying excessive force. Caution! If excessive force is applied, the connector could crack or be shaved which could lead to a defect in contact resistance.</p>
<p>Guiding condition</p>  <p>Mated condition</p> 	<p>When guided, the connectors are aligned parallel to each other with longitudinal and lateral movements restricted. Mate them parallel to each other.</p>

Apr. 1. 2025 Copyright 2025 HIROSE ELECTRIC CO., LTD. All Rights Reserved.

● Handle with care when un-mating connectors

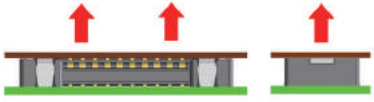
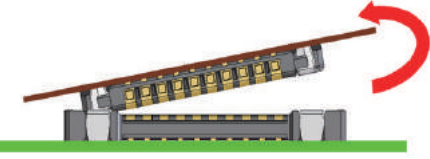
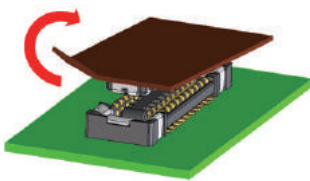
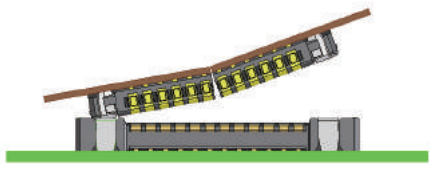
<p>OK</p> 	<p>Un-mate connectors parallel to each other.</p>
<p>OK</p>  <p>Pitch direction</p>	<p>If the connector cannot be un-mated parallel, it can be removed diagonally from the pitch direction, as shown in the left figure. However, the connector can be broken if the FPC is not rigid. Please confirm rigidity of the FPC at the time of trial production.</p>
<p>NG</p>  <p>Corner direction</p>	<p>Do not pull from the corner. If it is pulled from the corner as shown in the left figure, the contact and connector could be damaged.</p>
<p>NG</p> 	<p>Please provide a reinforcing plate for the FPC. If the rigidity of the FPC is not sufficient, the connector may break as shown in the left figure. Please check the action of the FPC to be used repeatedly. A reinforcing plate of 0.3mm or thicker made of glass epoxy material, or 0.2mm or thicker stainless steel is recommended</p>

MEMO

Apr. 1. 2025 Copyright 2025 HIROSE ELECTRIC CO., LTD. All Rights Reserved.

USA:

HIROSE ELECTRIC (U.S.A.), INC. HEADQUARTERS CHICAGO OFFICE
 2300 Warrenville Road, Suite 150,
 Downers Grove, IL 60515
 Phone : +1-630-282-6700
<http://www.hirose.com/us/>

USA:

HIROSE ELECTRIC (U.S.A.), INC. SAN JOSE OFFICE
 2841 Junction Ave, Suite 200
 San Jose, CA. 95134
 Phone : +1-408-253-9640
 Fax : +1-408-253-9641
<http://www.hirose.com/us/>

USA:

HIROSE ELECTRIC (U.S.A.), INC. DETROIT OFFICE (AUTOMOTIVE)
 17197 N. Laurel Park Drive, Suite 253,
 Livonia, MI 48152
 Phone : +1-734-542-9963
 Fax : +1-734-542-9964
<http://www.hirose.com/us/>

USA:

HIROSE ELECTRIC (U.S.A.), INC. BOSTON OFFICE
 300 Brickstone Square Suite 201,
 Andover, MA 01810
 Phone : +1-978-662-5255

THE NETHERLANDS:

HIROSE ELECTRIC EUROPE B.V.
 Hogehillweg #8 1101 CC Amsterdam Z-0
 Phone : +31-20-6557460
 Fax : +31-20-6557469
<http://www.hirose.com/eu/>

GERMANY:

HIROSE ELECTRIC EUROPE B.V. GERMAN BRANCH
 Schoenbergstr. 20, 73760 ostfildern
 Phone : +49-711-456002-1
 Fax : +49-711-456002-299
<http://www.hirose.com/eu/>

GERMANY:

HIROSE ELECTRIC EUROPE B.V. NUREMBERG OFFICE
 Neumeyerstrasse 22-26, 90411 Nurnberg
 Phone : +49-911 32 68 89 63
 Fax : +49-911 32 68 89 69
<http://www.hirose.com/eu/>

GERMANY:

HIROSE ELECTRIC EUROPE B.V. HANOVER OFFICE
 Bayernstr. 3, Haus C 30855 Langenhagen, Germany
 Phone : +49-511 97 82 61 30
 Fax : +49-511 97 82 61 35
<http://www.hirose.com/eu/>

FRANCE:

HIROSE ELECTRIC EUROPE B.V. PARIS OFFICE
 130 Avenue Joseph Kessel, Bat E, 78960
 Voisins le Bretonneux, France
 Phone : +33-1-85764886
 Fax : +33-1-85764823
<http://www.hirose.com/eu/>

UNITED KINGDOM:

HIROSE ELECTRIC EUROPE BV (UK BRANCH)
 4 Newton Court, Kelvin Drive, Knowlhill,
 Milton Keynes, MK5 8NH
 Phone : +44-1908 202050
 Fax : +44-1908 202058
<http://www.hirose.com/eu/>

CHINA:

HIROSE ELECTRIC (SHANGHAI) CO., LTD.
 18, Enterprise Center Tower 2, 209# Gong He
 Road, Jing'an District, Shanghai, CHINA 200070
 Phone : +86-21-6391-3355
 Fax : +86-21-6391-3335
<http://www.hirose.com/cn/>

CHINA:

HIROSE ELECTRIC (SHANGHAI) CO.,LTD. BEIJING BRANCH
 A1001, Ocean International Center, Building 56# East 4th
 Ring Middle Road, ChaoYang District, Beijing, 100025
 Phone : +86-10-5165-9332
 Fax : +86-10-5908-1381
<http://www.hirose.com/cn/>

CHINA:

HIROSE ELECTRIC TECHNOLOGIES (SHENZHEN) CO., LTD.
 Room 09-13, 19/F, Office Tower Shun Hing Square, Di Wang Commercial Centre,
 5002 Shen Nan Dong Road, Shenzhen City, Guangdong Province, 518008
 Phone : +86-755-8207-0851
 Fax : +86-755-8207-0873
<http://www.hirose.com/cn/>

HONG KONG:

HIROSE ELECTRIC HONGKONG TRADING CO., LTD.
 Room 1001, West Wing, Tsim Sha Tsui Centre, 66
 Mody Road, Tsim Sha Tsui East, Kowloon, Hong Kong
 Phone : +852-2803-5338
 Fax : +852-2591-6560
<http://www.hirose.com/hk/>

TAIWAN:

HIROSE ELECTRIC TAIWAN CO., LTD.
 103 8F, No.87, Zhengzhou Rd., Taipei
 Phone : +886-2-2555-7377
 Fax : +886-2-2555-7350
<http://www.hirose.com/tw/>

KOREA:

HIROSE KOREA CO.,LTD.
 143, Gongdan 1-daero, Siheung-si,
 Gyeonggi-do, 15084, Korea
 Phone : +82-31-496-7000
 Fax : +82-31-496-7100
<http://www.hirose.co.kr/>

SINGAPORE:

HIROSE ELECTRIC SINGAPORE PTE. LTD.
 03, Anson Road, #20-01, Springleaf Tower,
 Singapore 079909
 Phone : +65-6324-6113
 Fax : +65-6324-6123
<http://www.hirose.com/sg/>

INDIA:

HIROSE ELECTRIC SINGAPORE PTE. LTD. DELHI LIAISON OFFICE
 Office NO.552, Regus-Green Boulevard, Level5, Tower C,
 Sec62, Plot B-9A, Block B, Noida, 201301, Uttar Pradesh, India
 Phone : +91-12-660-8018
 Fax : +91-120-4804949
<http://www.hirose.com/sg/>

INDIA:

HIROSE ELECTRIC SINGAPORE PTE. LTD. BANGALORE LIAISON OFFICE
 Unit No-403, 4th Floor, No-84, Barton Centre, Mahatma
 Gandhi (MG) Road, Bangalore 560 001, Karnataka, India
 Phone : +91-80-4120 1907
 Fax : +91-80-4120 9908
<http://www.hirose.com/sg/>

MALAYSIA:

PENANG REPRESENTATIVE OFFICE
 73-3-1, Ideal@The One, Jalan Mahsuri, Bayan
 Lepas Penang, 11950, Malaysia
 Phone : +604-648-5536
<http://www.hirose.com/sg/>

THAILAND:

BANGKOK OFFICE (REPRESENTATIVE OFFICE)
 Unit 4703, 47th FL., 1 Empire Tower, South Sathorn
 Road, Yannawa, Sathorn, Bangkok 10120 Thailand
 Phone : +66-2-686-1255
 Fax : +66-2-686-3433
<http://www.hirose.com/sg/>



HIROSE ELECTRIC CO.,LTD.

2-6-3,Nakagawa Chuoh,Tsuzuki-Ku,Yokohama-Shi 224-8540,JAPAN
 TEL: +81-45-620-3526 Fax: +81-45-591-3726
<http://www.hirose.com>
<http://www.hirose-connectors.com>