

ER8 Series

PCIe Gen.4 High Speed Transmission (16⁺Gbps), 0.8mm Pitch, Board-to-Board Connectors

FunctionMAX™



High Speed



Wide Variation

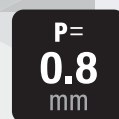

P= 0.8mm

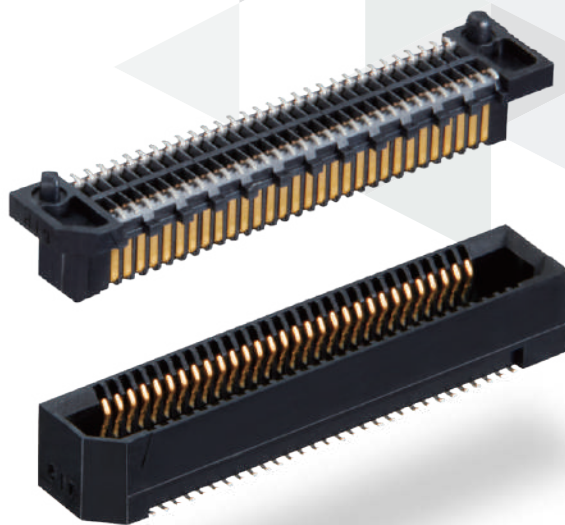

Features

1. Pitch : 0.8mm
2. Variations :
Right Angle / Parallel / Coplanar
3. Stacking Height :
7/9/10/12mm
4. Number of Positions :
10/20/30/40/50/60
70/80/100/120/140pos.
5. Large Guide for Easy Mating

Self-alignment Range: ± 1.6 mm
6. Unique Contact Design for Smooth Mating
7. Samtec “Edge Rate[®]”
Licensed Second Source

High Speed Transmission Characteristics

● Differential Insertion Loss

Supports PCIe Gen.4 with sufficient margin.

● Differential Impedance

85Ω (Tr=35ps, 20%-80%)

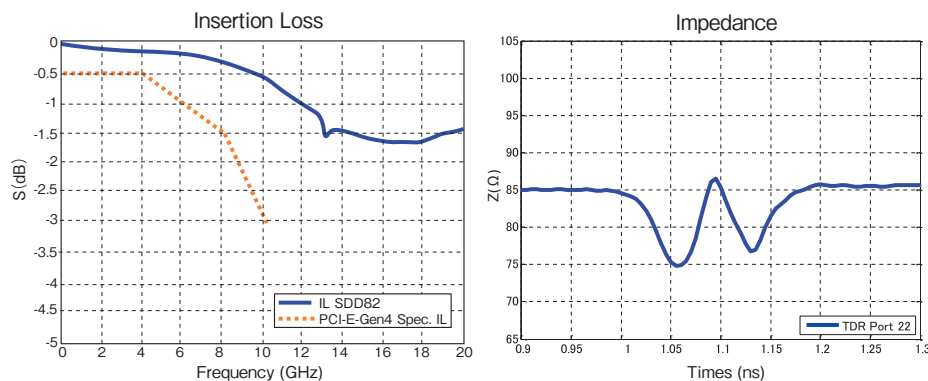

Product Specification

Rated Current (Note 1)	0.5A (Signal)	Operating Temperature (Note 2)	-55 to +125°C
Rated Voltage	100V AC	Storage Temperature (Note 3)	-10 to +60°C

Item	Specifications	Conditions
Contact Resistance	50mΩ Max.	100mA
Insulation Resistance	1000MΩ Min.	100V DC
Withstanding Voltage	No flashover or insulation breakdown	300V AC for 1 min.
Mating Durability	Contact resistance change : 15mΩ Max. No flash over or insulation breakdown. No damage, cracks or part dislocation.	100 times
Vibration Resistance	No electrical discontinuity of 1 μs Min.	Frequency : 20 to 500Hz, Power spectral density : 0.02G ² /Hz 3 times in each of the 3 directions
Shock Resistance	No electrical discontinuity of 1 μs Min.	980m/s ² , Duration of pulse 6ms, 90 minutes each of 3-axis direction
Temperature Cycles	Contact resistance change : 15mΩ Max. Insulation resistance : 1000MΩ Min. No flashover or insulation breakdown No damage, cracks or part dislocation.	25°C , 90-95% RH : 120 min. ↑ ↓ 120 min. 65°C , 90-95% RH : 120 min. 12 times

Note 1 : Current rating per 1 contact is used.

Note 2 : Includes temperature rise due to current flow.

Note 3 : The term "storage" refers to products stored for long period of time prior to mounting and use.

Note 4 : Information contained in this catalog represents general requirements for this Series. Contact us for the drawings and specifications for a specific part number shown.

Materials / Finish

● Straight Receptacle / Header

Component	Material	Color / Finish	Remarks
Insulation	LCP	Black	UL94V-0
Signal Contact	Copper Alloy	Contact Area : Gold Plating Mounting Area : Tin Plating	—

● Right Angle Receptacle / Header

Component	Material	Color / Finish	Remarks
Insulation	LCP	Black	UL94V-0
Signal Contact	Copper Alloy	Contact Area : Gold Plating Mounting Area : Tin Plating	—
Retention Peg	Copper Alloy	Mounting Area : Tin Plating	—
Retention Pin	Copper Alloy	Mounting Area : Tin Plating	—

Product Number Structure

Refer to the chart below when determining the product specifications from the product number.
Please select from the product numbers listed in this catalog when placing orders.

■ Straight Header

■ Straight Receptacle

ER8 # - ### # - 0.8 SV - #H (##)

① ② ③ ④ ⑤ ⑥ ⑦ ⑧

■ Right Angle Header

■ Right Angle Receptacle

ER8 # - ### # - 0.8 SH (##)

① ② ③ ④ ⑤ ⑥ ⑧

① Series Name	ER8	⑤ Contact Pitch	0.8mm
② Specification	Blank : Standard Product L : With Latch (140pos. only)	⑥ Contact Type	SV : Straight Type SH : Right Angle Type
③ No. of Pos.	10-140	⑦ Height	2, 5 : Header 5, 7 : Receptacle
④ Connector Type	S : Receptacle P : Header	⑧ Plating Specification	Blank : Contact Area Gold (0.76 μm) +Ni (2.54 μm) (10) : Contact Area Gold (0.25 μm) +Ni (1.25 μm)

Function Chart

● Parallel Connection (10 to 120pos.)

Straight Header

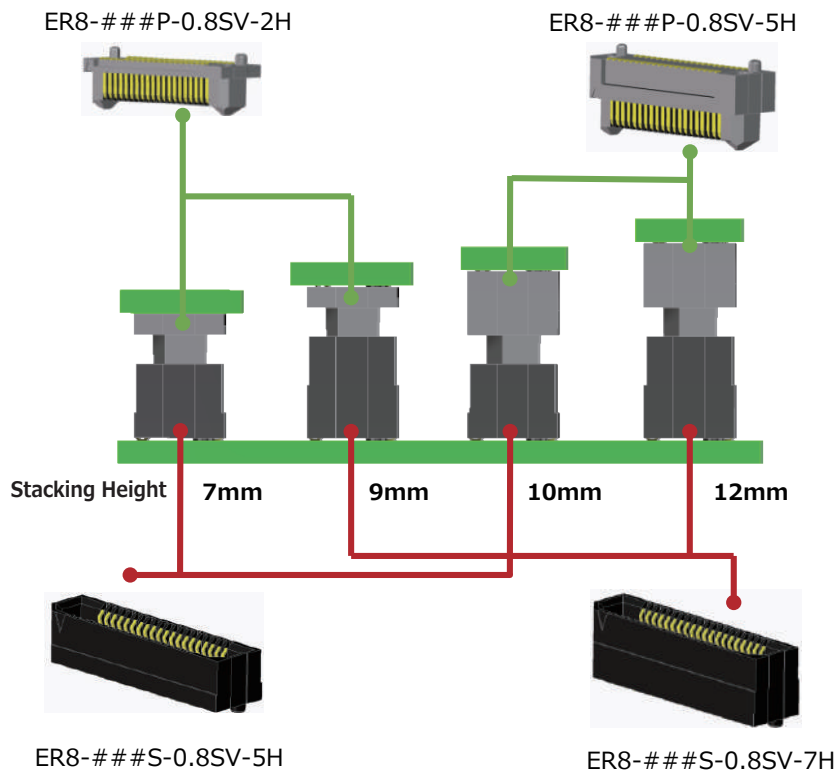

Straight Receptacle

● Right Angle Connection

(120pos. only)

Straight Header

ER8-120P-0.8SV-2H
ER8-120P-0.8SV-5H

2H Type W=(13.03)
5H Type W=(16.03)

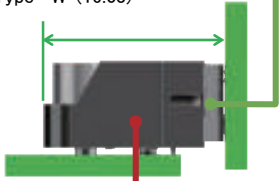

ER8-120S-0.8SH
Right Angle Receptacle

(120, 140pos.)

Right Angle Header

ER8#-###P-0.8SH

5H Type W=(16.41)
7H Type W=(18.33)

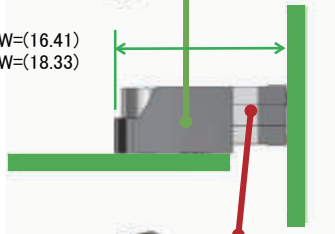

ER8#-###S-0.8SV-5H
ER8-120S-0.8SV-77H
Straight Receptacle

● Coplanar Connection (120pos. only)

Right Angle Header

ER8-120P-0.8SH



ER8-120S-0.8SH
Right Angle Receptacle

● Stacking Height Variation

Stacking Height	No. of Pos.										
	10	20	30	40	50	60	70	80	100	120	
7mm	○	○	○	○	○	○	○	○	○	○	○
9mm	○	○	○	○	○	○	○	○	○	○	○
10mm	○	○	○	○	○	○	○	○	○	○	○
12mm	○	○	○	○	○	○	○	○	○	○	○

○ = Available

Signal Integrity

● Pin Assignment

To match 85Ω differential impedance and to reduce crosstalk, a staggered GSSG pin assignment is recommended for ER8.

* Analysis results only.

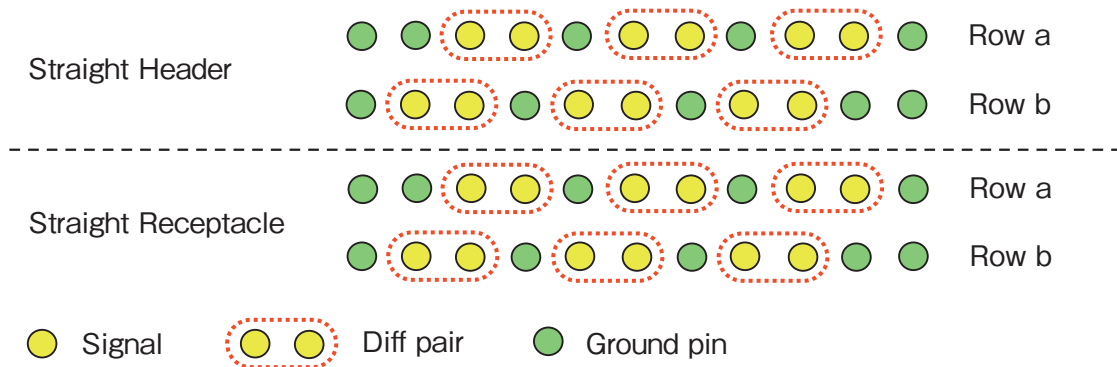

● Impedance

The differential impedance is 85Ω at 35ps rise time (20% to 80%)

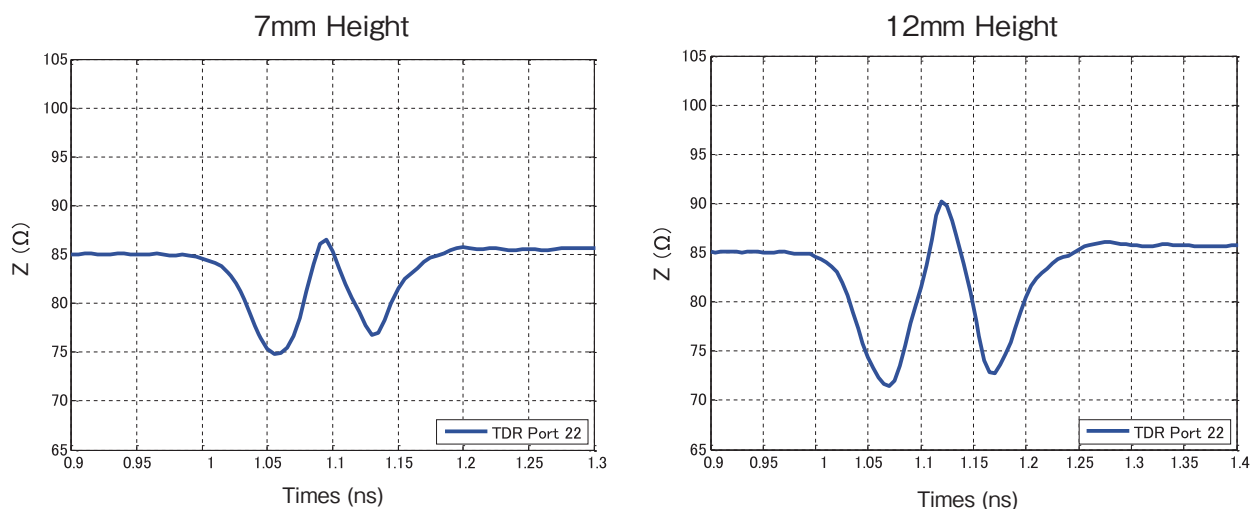

● Insertion Loss

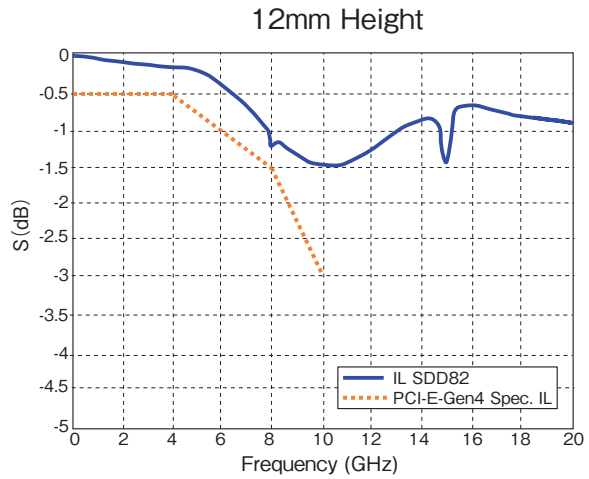
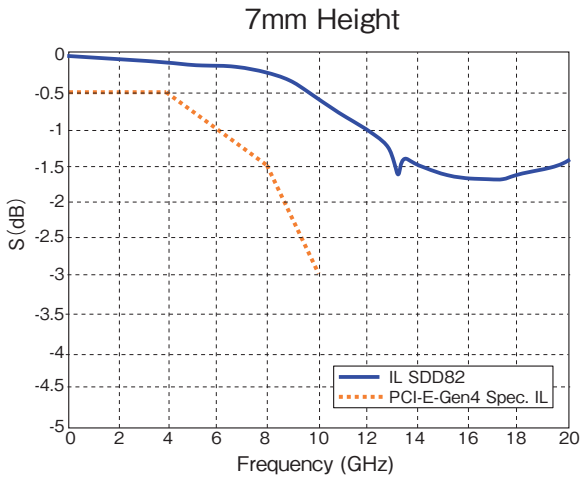

● Return Loss

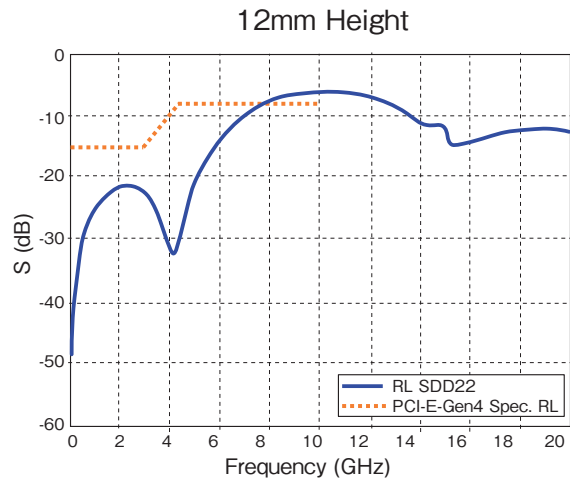
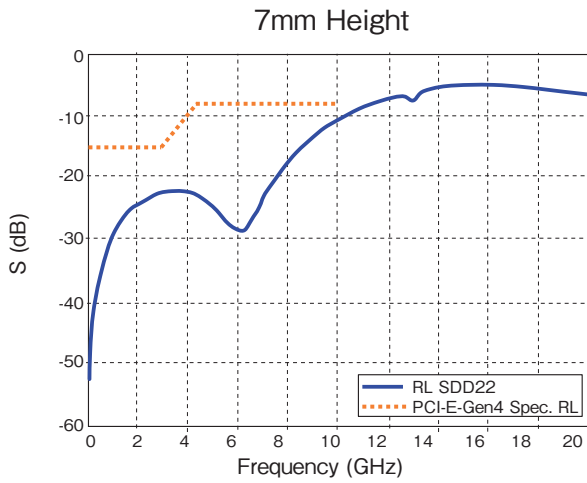

● Crosstalk

The below diagram shows the NEXT and FEXT in the same row with the highest influence.

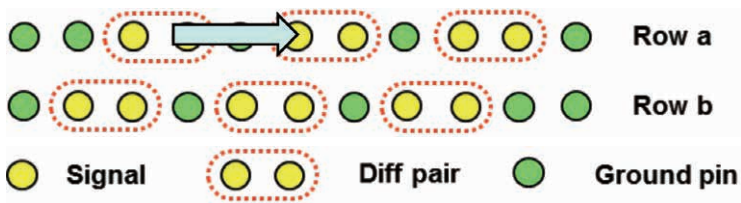

● Near-end Crosstalk (NEXT)

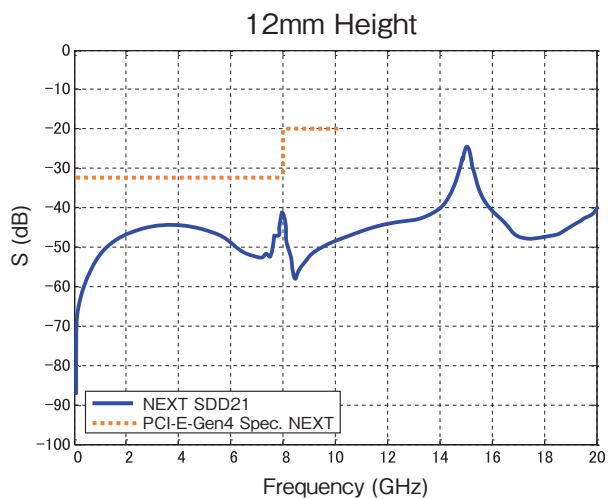
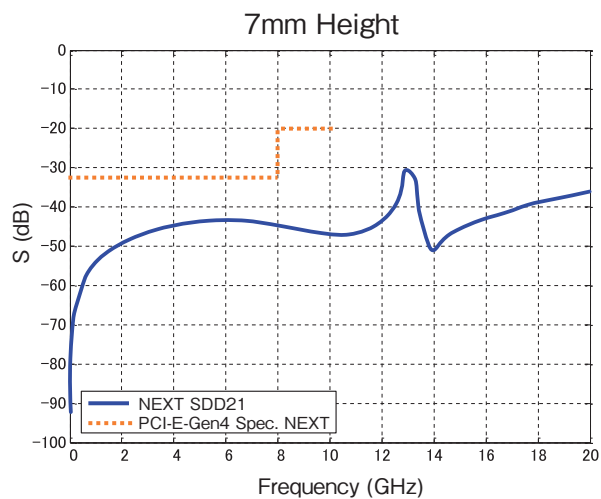

● Far-end Crosstalk (FEXT)

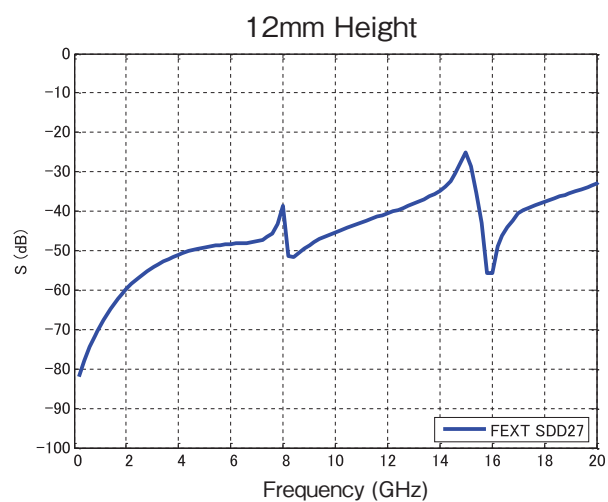
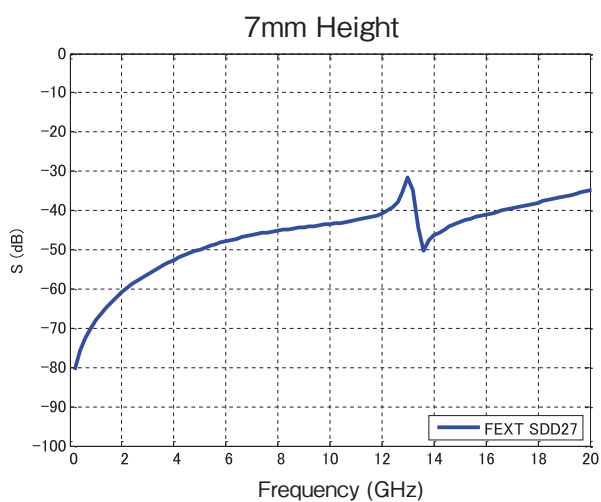

Straight Header

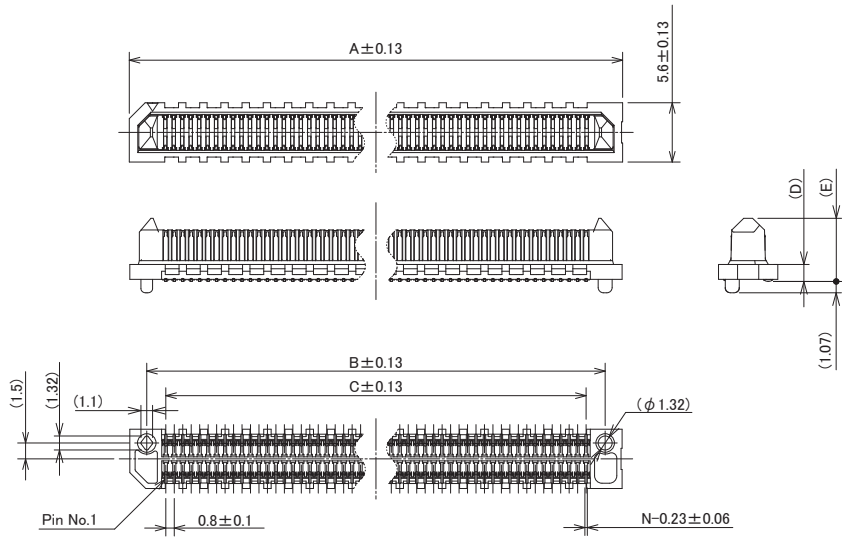

Unit : mm

Part No.	HRS No.	No. of Pos.	A	B	C	D	E	Purchase Unit
ER8-10P-0.8SV-2H(##)	CL0625-0008-8-##	10	10	6.8	3.2	1.605	5.965	450pcs per reel
ER8-20P-0.8SV-2H(##)	CL0625-0011-0-##	20	14	10.8	7.2	1.605	5.965	475pcs per reel
ER8-30P-0.8SV-2H(##)	CL0625-0012-0-##	30	18	14.8	11.2	1.605	5.965	350pcs per reel
ER8-40P-0.8SV-2H(##)	CL0625-0013-0-##	40	22	18.8	15.2	1.605	5.965	
ER8-50P-0.8SV-2H(##)	CL0625-0009-0-##	50	26	22.8	19.2	1.605	5.965	
ER8-60P-0.8SV-2H(##)	CL0625-0017-0-##	60	30	26.8	23.2	1.605	5.965	
ER8-70P-0.8SV-2H(##)	CL0625-0021-0-##	70	34	30.8	27.2	1.605	5.965	
ER8-80P-0.8SV-2H(##)	CL0625-0022-0-##	80	38	34.8	31.2	1.605	5.965	
ER8-100P-0.8SV-2H(##)	CL0625-0023-0-##	100	46	42.8	39.2	1.605	5.965	
ER8-120P-0.8SV-2H(##)	CL0625-0003-4-##	120	54	50.8	47.2	1.605	5.965	
ER8-10P-0.8SV-5H(##)	CL0625-0024-0-##	10	10	6.8	3.2	4.605	8.905	325pcs per reel
ER8-20P-0.8SV-5H(##)	CL0625-0025-0-##	20	14	10.8	7.2	4.605	8.905	
ER8-30P-0.8SV-5H(##)	CL0625-0026-0-##	30	18	14.8	11.2	4.605	8.905	
ER8-40P-0.8SV-5H(##)	CL0625-0020-0-##	40	22	18.8	15.2	4.605	8.905	250pcs per reel
ER8-50P-0.8SV-5H(##)	CL0625-0027-0-##	50	26	22.8	19.2	4.605	8.905	
ER8-60P-0.8SV-5H(##)	CL0625-0019-0-##	60	30	26.8	23.2	4.605	8.905	
ER8-70P-0.8SV-5H(##)	CL0625-0028-0-##	70	34	30.8	27.2	4.605	8.905	
ER8-80P-0.8SV-5H(##)	CL0625-0029-0-##	80	38	34.8	31.2	4.605	8.905	
ER8-100P-0.8SV-5H(##)	CL0625-0030-0-##	100	46	42.8	39.2	4.605	8.905	
ER8-120P-0.8SV-5H(##)	CL0625-0031-0-##	120	54	50.8	47.2	4.605	8.905	

Right Angle Header

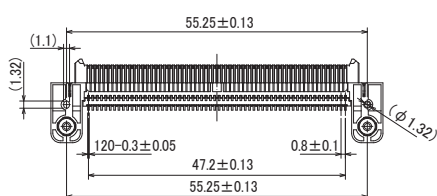
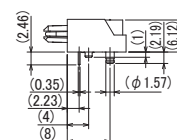
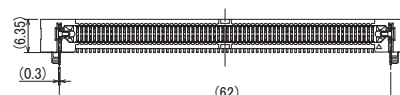
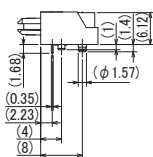
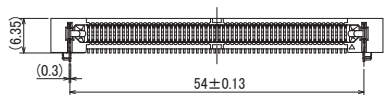
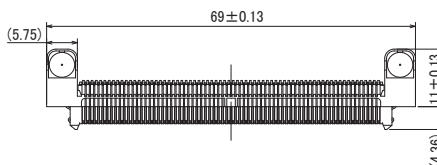
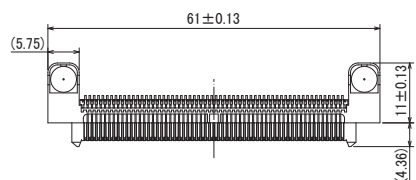

ER8-120P-0.8SH(##)

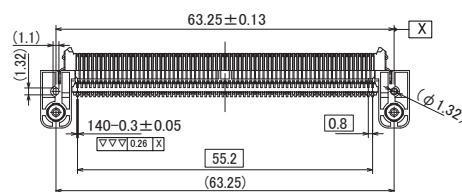

ER8L-140P-0.8SH(##)

Unit : mm

Part No.	HRS No.	No. of Pos.	Purchase Unit
ER8-120P-0.8SH(##)	CL0625-0047-0-##	120	200pcs per reel
ER8L-140P-0.8SH(##)	CL0625-1002-0-##	140	

Straight Receptacle

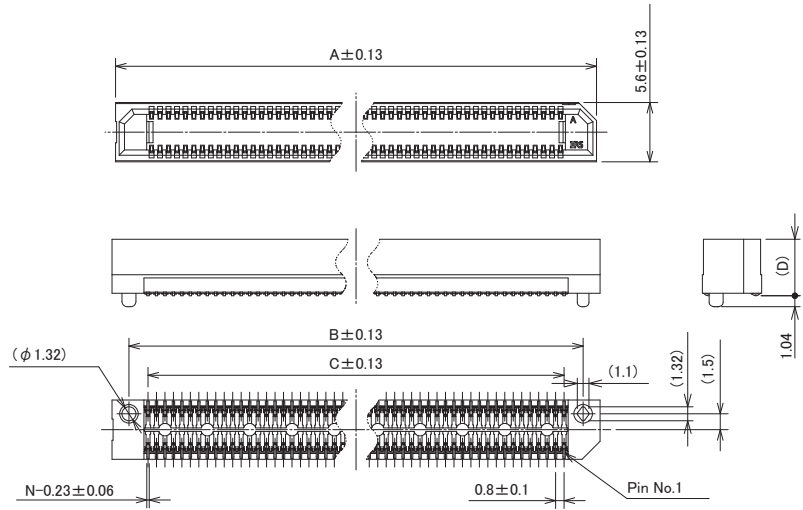

Unit : mm

Part No.	HRS No.	No. of Pos.	A	B	C	D	Purchase Unit
ER8-10S-0.8SV-5H(##)	CL0625-0007-5-##	10	10	6.8	3.2	5.335	475pcs per reel
ER8-20S-0.8SV-5H(##)	CL0625-0014-0-##	20	14	10.8	7.2	5.335	500pcs per reel
ER8-30S-0.8SV-5H(##)	CL0625-0015-0-##	30	18	14.8	11.2	5.335	475pcs per reel
ER8-40S-0.8SV-5H(##)	CL0625-0016-0-##	40	22	18.8	15.2	5.335	375pcs per reel
ER8-50S-0.8SV-5H(##)	CL0625-0010-0-##	50	26	22.8	19.2	5.335	
ER8-60S-0.8SV-5H(##)	CL0625-0018-0-##	60	30	26.8	23.2	5.335	
ER8-70S-0.8SV-5H(##)	CL0625-0032-0-##	70	34	30.8	27.2	5.335	
ER8-80S-0.8SV-5H(##)	CL0625-0033-0-##	80	38	34.8	31.2	5.335	
ER8-100S-0.8SV-5H(##)	CL0625-0034-0-##	100	46	42.8	39.2	5.335	
ER8-120S-0.8SV-5H(##)	CL0625-0035-0-##	120	54	50.8	47.2	5.335	
ER8-10S-0.8SV-7H(##)	CL0625-0036-0-##	10	10	6.8	3.2	7.25	
ER8-20S-0.8SV-7H(##)	CL0625-0037-0-##	20	14	10.8	7.2	7.25	375pcs per reel
ER8-30S-0.8SV-7H(##)	CL0625-0038-0-##	30	18	14.8	11.2	7.25	400pcs per reel
ER8-40S-0.8SV-7H(##)	CL0625-0039-0-##	40	22	18.8	15.2	7.25	300pcs per reel
ER8-50S-0.8SV-7H(##)	CL0625-0040-0-##	50	26	22.8	19.2	7.25	
ER8-60S-0.8SV-7H(##)	CL0625-0041-0-##	60	30	26.8	23.2	7.25	
ER8-70S-0.8SV-7H(##)	CL0625-0042-0-##	70	34	30.8	27.2	7.25	
ER8-80S-0.8SV-7H(##)	CL0625-0043-0-##	80	38	34.8	31.2	7.25	
ER8-100S-0.8SV-7H(##)	CL0625-0044-0-##	100	46	42.8	39.2	7.25	
ER8-120S-0.8SV-7H(##)	CL0625-0045-0-##	120	54	50.8	47.2	7.25	

Right Angle Receptacle

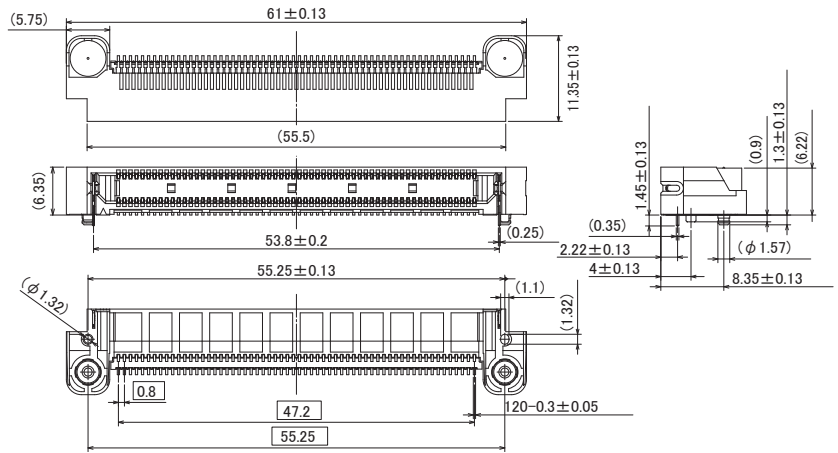

Part No.	HRS No.	No. of Pos.	Purchase Unit
ER8-120S-0.8SH(##)	CL0625-1001-4-##	120	200pcs per reel

Recommended PCB Mouting Pattern (Metal Mask Thickness : $t=0.15\text{mm}$)

● Straight Header

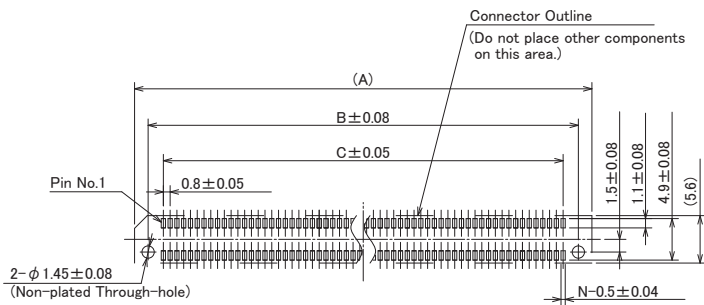

Unit : mm

No. of Pos.	A	B	C
10	10	6.8	3.2
20	14	10.8	7.2
30	18	14.8	11.2
40	22	18.8	15.2
50	26	22.8	19.2
60	30	26.8	23.2
70	34	30.8	27.2
80	38	34.8	31.2
100	46	42.8	39.2
120	54	50.8	47.2

● Right Angle Header

120pos.

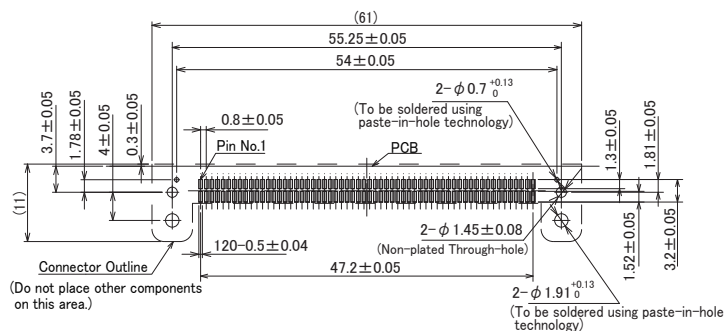

140pos.

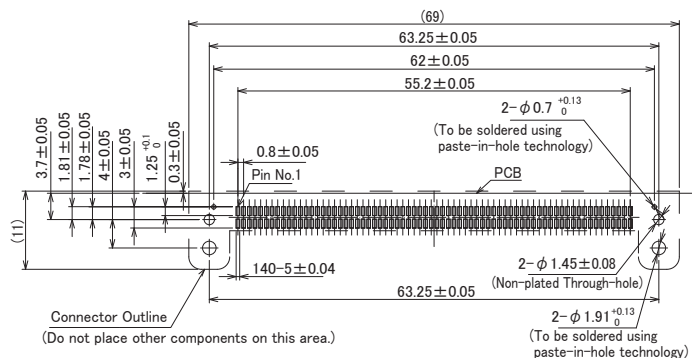

● Straight Receptacle

10-120pos.

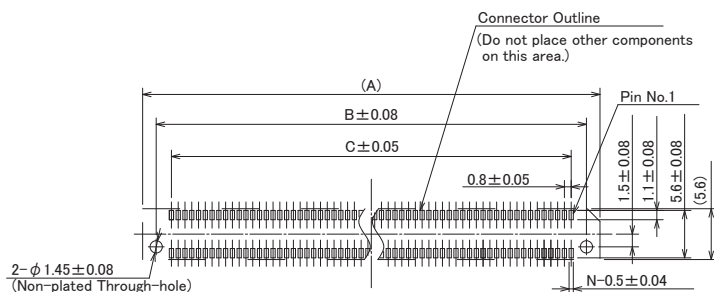

140pos.

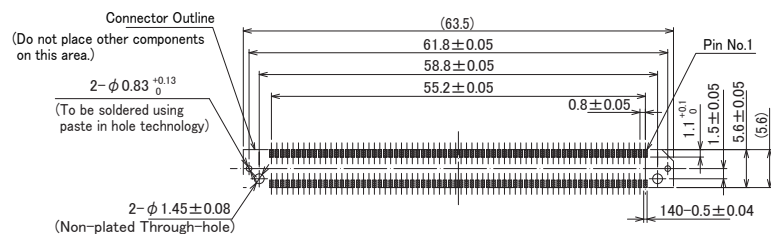

Connection Variations

Right Angle Receptacle

ER8-120S-0.8SH(##)
120pos. only



Right Angle Header

ER8#-###P-0.8SH(##)
120, 140pos.

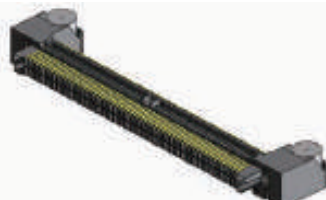

Coplanar Connection

Right Angle Connection

Straight Receptacle

ER8#-###S-0.8SV-#H(##)
10 to 140pos.

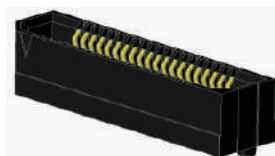

Straight Header

ER8-###P-0.8SV-#H(##)
10 to 120pos.

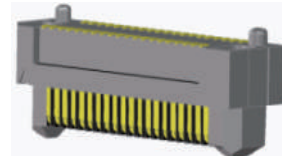

Parallel Connection

Parallel Connection Type

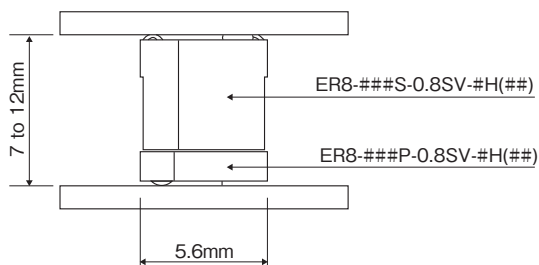

Right Angle Connection Type
(Straight Header + Right Angle Receptacle)

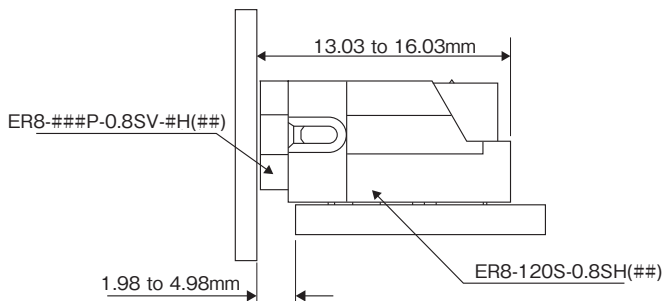

Right Angle Connection Type
(Right Angle Header + Straight Receptacle)

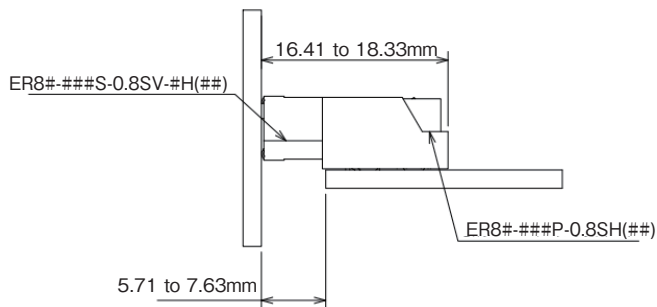

Coplanar Connection Type

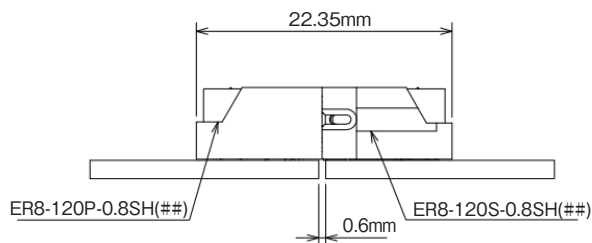

Edge Rate (Samtec) Part No. Compatibility List

● Straight Header

Part No.	HRS No.	Samtec Part No.
ER8-10P-0.8SV-2H	CL0625-0008-8-00	ERM8-005-02.0-S-DV-K-TR
ER8-20P-0.8SV-2H	CL0625-0011-0-00	ERM8-010-02.0-S-DV-K-TR
ER8-30P-0.8SV-2H	CL0625-0012-0-00	—
ER8-40P-0.8SV-2H	CL0625-0013-0-00	ERM8-020-02.0-S-DV-K-TR
ER8-50P-0.8SV-2H	CL0625-0009-0-00	ERM8-025-02.0-S-DV-K-TR
ER8-60P-0.8SV-2H	CL0625-0017-0-00	ERM8-030-02.0-S-DV-K-TR
ER8-70P-0.8SV-2H	CL0625-0021-0-00	ERM8-035-02.0-S-DV-K-TR
ER8-80P-0.8SV-2H	CL0625-0022-0-00	ERM8-040-02.0-S-DV-K-TR
ER8-100P-0.8SV-2H	CL0625-0023-0-00	ERM8-050-02.0-S-DV-K-TR
ER8-120P-0.8SV-2H	CL0625-0003-4-00	ERM8-060-02.0-S-DV-K-TR
ER8-10P-0.8SV-5H	CL0625-0024-0-00	ERM8-005-05.0-S-DV-K-TR
ER8-20P-0.8SV-5H	CL0625-0025-0-00	ERM8-010-05.0-S-DV-K-TR
ER8-30P-0.8SV-5H	CL0625-0026-0-00	—
ER8-40P-0.8SV-5H	CL0625-0020-0-00	ERM8-020-05.0-S-DV-K-TR
ER8-50P-0.8SV-5H	CL0625-0027-0-00	ERM8-025-05.0-S-DV-K-TR
ER8-60P-0.8SV-5H	CL0625-0019-0-00	ERM8-030-05.0-S-DV-K-TR
ER8-70P-0.8SV-5H	CL0625-0028-0-00	ERM8-035-05.0-S-DV-K-TR
ER8-80P-0.8SV-5H	CL0625-0029-0-00	ERM8-040-05.0-S-DV-K-TR
ER8-100P-0.8SV-5H	CL0625-0030-0-00	ERM8-050-05.0-S-DV-K-TR
ER8-120P-0.8SV-5H	CL0625-0031-0-00	ERM8-060-05.0-S-DV-K-TR

● Right Angle Header

Part No.	HRS No.	Samtec Part No.
ER8-120P-0.8SH	CL0625-0047-0-00	ERM8-060-01-S-D-RA-K-TR
ER8L-140P-0.8SH	CL0625-1002-0-00	ERM8-070-01-S-D-RA-L-K-TR

● Straight Receptacle

Part No.	HRS No.	Samtec Part No.
ER8-10S-0.8SV-5H	CL0625-0007-5-00	ERF8-005-05.0-S-DV-K-TR
ER8-20S-0.8SV-5H	CL0625-0014-0-00	ERF8-010-05.0-S-DV-K-TR
ER8-30S-0.8SV-5H	CL0625-0015-0-00	—
ER8-40S-0.8SV-5H	CL0625-0016-0-00	ERF8-020-05.0-S-DV-K-TR
ER8-50S-0.8SV-5H	CL0625-0010-0-00	ERF8-025-05.0-S-DV-K-TR
ER8-60S-0.8SV-5H	CL0625-0018-0-00	ERF8-030-05.0-S-DV-K-TR
ER8-70S-0.8SV-5H	CL0625-0032-0-00	ERF8-035-05.0-S-DV-K-TR
ER8-80S-0.8SV-5H	CL0625-0033-0-00	ERF8-040-05.0-S-DV-K-TR
ER8-100S-0.8SV-5H	CL0625-0034-0-00	ERF8-050-05.0-S-DV-K-TR
ER8-120S-0.8SV-5H	CL0625-0035-0-00	ERF8-060-05.0-S-DV-K-TR
ER8L-140S-0.8SV-5H	CL0625-0046-0-00	ERF8-070-05.0-S-DV-L-K-TR
ER8-10S-0.8SV-7H	CL0625-0036-0-00	ERF8-005-07.0-S-DV-K-TR
ER8-20S-0.8SV-7H	CL0625-0037-0-00	ERF8-010-07.0-S-DV-K-TR
ER8-30S-0.8SV-7H	CL0625-0038-0-00	—
ER8-40S-0.8SV-7H	CL0625-0039-0-00	ERF8-020-07.0-S-DV-K-TR
ER8-50S-0.8SV-7H	CL0625-0040-0-00	ERF8-025-07.0-S-DV-K-TR
ER8-60S-0.8SV-7H	CL0625-0041-0-00	ERF8-030-07.0-S-DV-K-TR
ER8-70S-0.8SV-7H	CL0625-0042-0-00	ERF8-035-07.0-S-DV-K-TR
ER8-80S-0.8SV-7H	CL0625-0043-0-00	ERF8-040-07.0-S-DV-K-TR
ER8-100S-0.8SV-7H	CL0625-0044-0-00	ERF8-050-07.0-S-DV-K-TR
ER8-120S-0.8SV-7H	CL0625-0045-0-00	ERF8-060-07.0-S-DV-K-TR

● Right Angle Receptacle

Part No.	HRS No.	Samtec Part No.
ER8-120S-0.8SH	CL0625-1001-4-00	ERF8-060-01-L-D-RA-TR

Mating Operation

● Mating Self-Alignment Tolerance (Note)

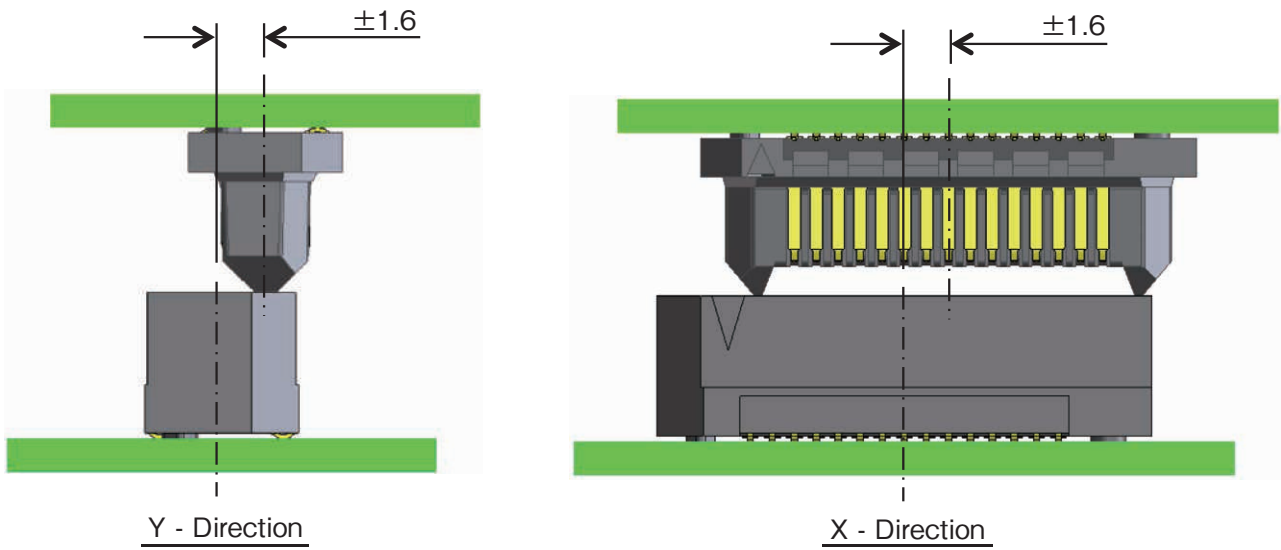

● Mating Angle Tolerance (Note)

A mating angle of 5° is allowed in the longitudinal (X) direction. Mating at an angle in the lateral (Y) direction is not recommended.

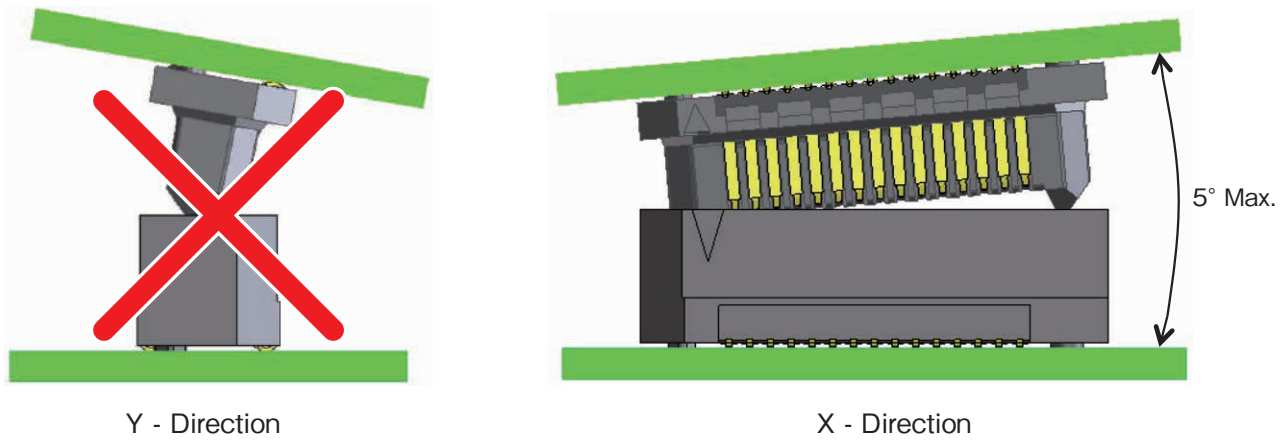

Note : The above mating conditions show the allowed values for the mating self-alignment and mating angles separately. The self alignment tolerance and angle tolerance are not satisfied at the same time.

Recommended Spacer Height

Spacers are required to support PWB's and protect the SMT solder joints.

Unit : mm

Stacking Height	Recommended Spacer Height
7	7.15 ± 0.05
9	9.15 ± 0.05
10	10.15 ± 0.05
12	12.15 ± 0.05

Mounting Temperature Profile (Reference)

● Pb-Free Assembly

Preheat / Soak (150 to 200°C)	Max. Ramp Up Rate	Reflow Time (217°C Min.)	Peak Temperature	Peak Temperature Time	Cooling Rate	Time Between Normal Temperature and Peak
60 - 120 sec.	3°C Max./s	40 - 150 sec.	260°C	30 sec. Max.	6°C Max./s	8 min Min.

Recommended Temperature Profile

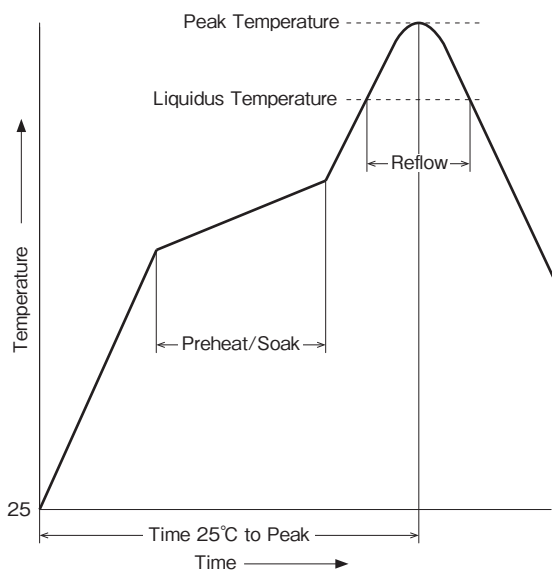

Temperature profile may change depending on the solder paste types, manufacturers, PCB size, and other soldering materials. Please fully check the mounting conditions before use.

Cleaning Conditions

● Cleaning with Organic Solvent

Solvent	Cleaning at Normal Temperature	Heated Cleaning
IPA (Isopropyl Alcohol)	Yes	Yes
HCFC (Hydrochlorofluorocarbon)	Yes	Yes

● Cleaning with Water

When water-type cleaning agents (terpene, alkaline saponification agents) are used, select cleaning agents based on the 'table of influence' on metals and resins issued by the cleaning agent manufacturer.

Caution : Do not leave the connector with any water content left on it.

● Cleaning Precautions

If flux or cleaning agent remains on the connector during part cleaning with organic solvent and water-based agents, it may cause deterioration of electrical performance. Confirm cleaning is performed properly.

While Taking into Consideration

Specifications mentioned in this catalog are reference values.

When considering to order or use this product, please confirm the Drawing and Product Specifications sheets.

Use an appropriate cable when using the connector in combination with cables.

If considering usage of a non- specified cable, please contact your sales representative.

If assembly process is done by jigs & tools which are not identified by Hirose, assurance will not be given.

If considering usage for below mentioned applications, please contact your sales representative.

In cases where the application will demand a high level of reliability, such as automotive, medical instruments, public infrastructure, aerospace/ defense etc. Hirose must review before assurance of reliability can be given.