

Jul.1.2024 Copyright 2024 HIROSE ELECTRIC CO., LTD. All Rights Reserved.
 In case of consideration for using Automotive equipment / device which demand high reliability, kindly contact our sales window correspondents.

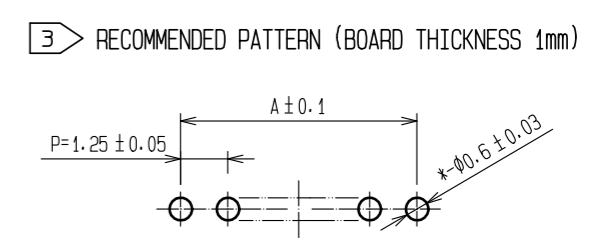
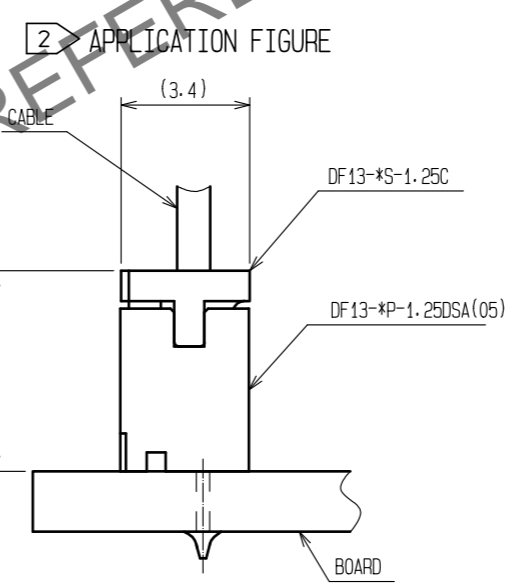
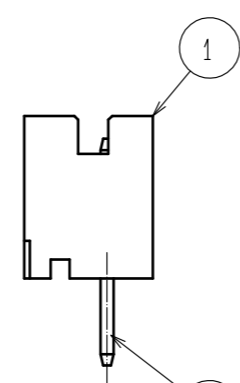
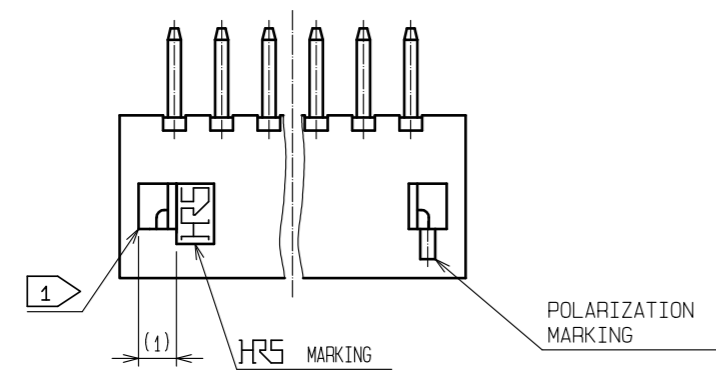
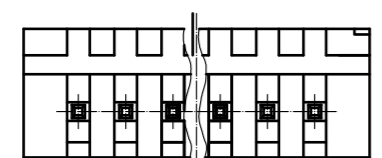
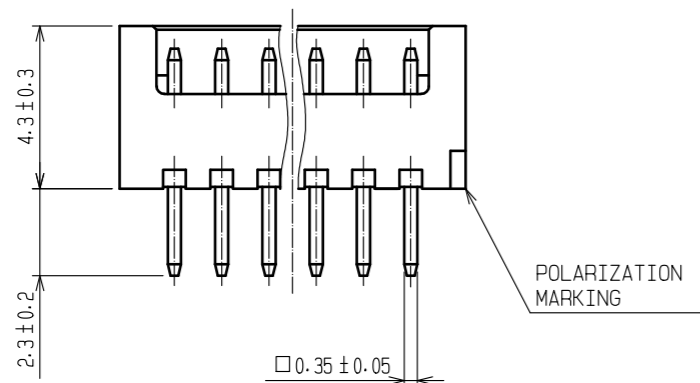
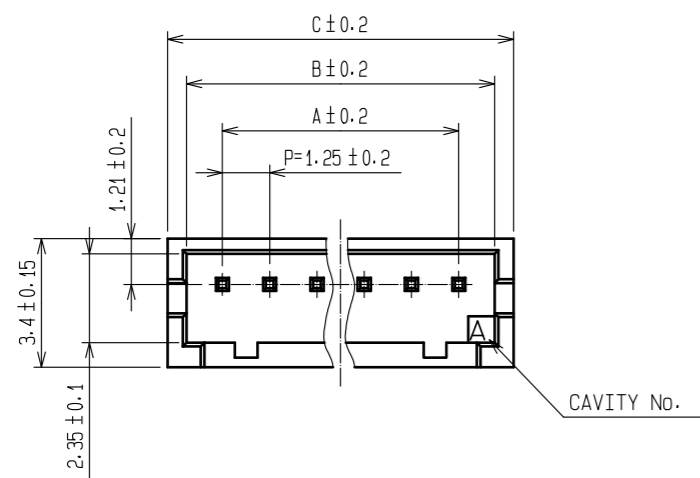

PART No.	CODE No.	NUMBER OF CONTACTS	A	B	C
DF13- 2P-1.25DSA(05)	CL536-0101-9-05	2	1.25	3.15	4.15
DF13- 3P-1.25DSA(05)	CL536-0102-1-05	3	2.5	4.4	5.4
DF13- 4P-1.25DSA(05)	CL536-0103-4-05	4	3.75	5.65	6.65
DF13- 5P-1.25DSA(05)	CL536-0104-7-05	5	5	6.9	7.9
DF13- 6P-1.25DSA(05)	CL536-0105-0-05	6	6.25	8.15	9.15
DF13- 7P-1.25DSA(05)	CL536-0106-2-05	7	7.5	9.4	10.4
DF13- 8P-1.25DSA(05)	CL536-0107-5-05	8	8.75	10.65	11.65
DF13- 9P-1.25DSA(05)	CL536-0108-8-05	9	10	11.9	12.9
DF13-10P-1.25DSA(05)	CL536-0109-0-05	10	11.25	13.15	14.15
DF13-11P-1.25DSA(05)	CL536-0110-0-05	11	12.5	14.4	15.4
DF13-12P-1.25DSA(05)	CL536-0111-2-05	12	13.75	15.65	16.65
DF13-13P-1.25DSA(05)	CL536-0112-5-05	13	15	16.9	17.9
DF13-14P-1.25DSA(05)	CL536-0113-8-05	14	16.25	18.15	19.15
DF13-15P-1.25DSA(05)	CL536-0114-0-05	15	17.5	19.4	20.4

HRS DRAWING FOR REFERENCE

- 1 WHEN THIS CONNECTOR HAS TWO OR THREE CONTACTS, THE LOCK OF CONNECTOR SHALL BE SET AT THE CENTER OF HOUSING. IN CASE THAT THE NUMBER OF CONTACTS IS MORE THAN FOUR, THE TWO LOCKS SHALL BE SET IN ACCORDANCE WITH THE DRAWINGS.
- 2 WHEN THIS CONNECTOR MATES WITH DF13-*S-1.25C, THE MATING HEIGHT IS 5.3mm.
- 3 RECOMMENDED THROUGH HOLE DIA. : $\phi 0.6 \pm 0.03$
- 4 100 CONNECTORS ARE IN ONE PACK.

1	POLYAMIDE	BEIGE (NATURAL) . UL94V-0	2	BRASS	SURFACE:TIN PLATED 1μm min UNDER PLATING:COPPER PLATED 1μm min		
NO.	MATERIAL	FINISH . REMARKS	NO.	MATERIAL	FINISH . REMARKS		
UNITS mm		SCALE 5 : 1	COUNT	DESCRIPTION OF REVISIONS	DESIGNED	CHECKED	DATE
HRS HIROSE ELECTRIC CO., LTD.		APPROVED : SJ. OKAMURA	20211217	DRAWING NO.	EDC-083673-05-00		
		CHECKED : SZ. ONO	20211217	PART NO.	DF13- * P-1. 25DSA(05)		
		DESIGNED : HT. SATO	20211217	CODE NO.	CL536-		
		DRAWN : SK. CHIBA	20211217				