

### 1. Scope

This document specifies the cable assembly processes of DF80 series(DF80※-\*P-0.5SD, DF80※-\*P-SHL) terminated with micro coaxial cable .

### 2. Part Number

Item	Description
DF80※-*P-0.5SD	Connector unit
DF80※-*P-SHL	Shell

※: Classification  
\* : Pin counts

### 3. Required Components

The connector (DF80 series) consists of a connector unit and a shell.

The assembly process is as follows;

- Solder the center conductor of micro coaxial cables / discrete cable to the connector unit
- Assemble the shell to the connector unit

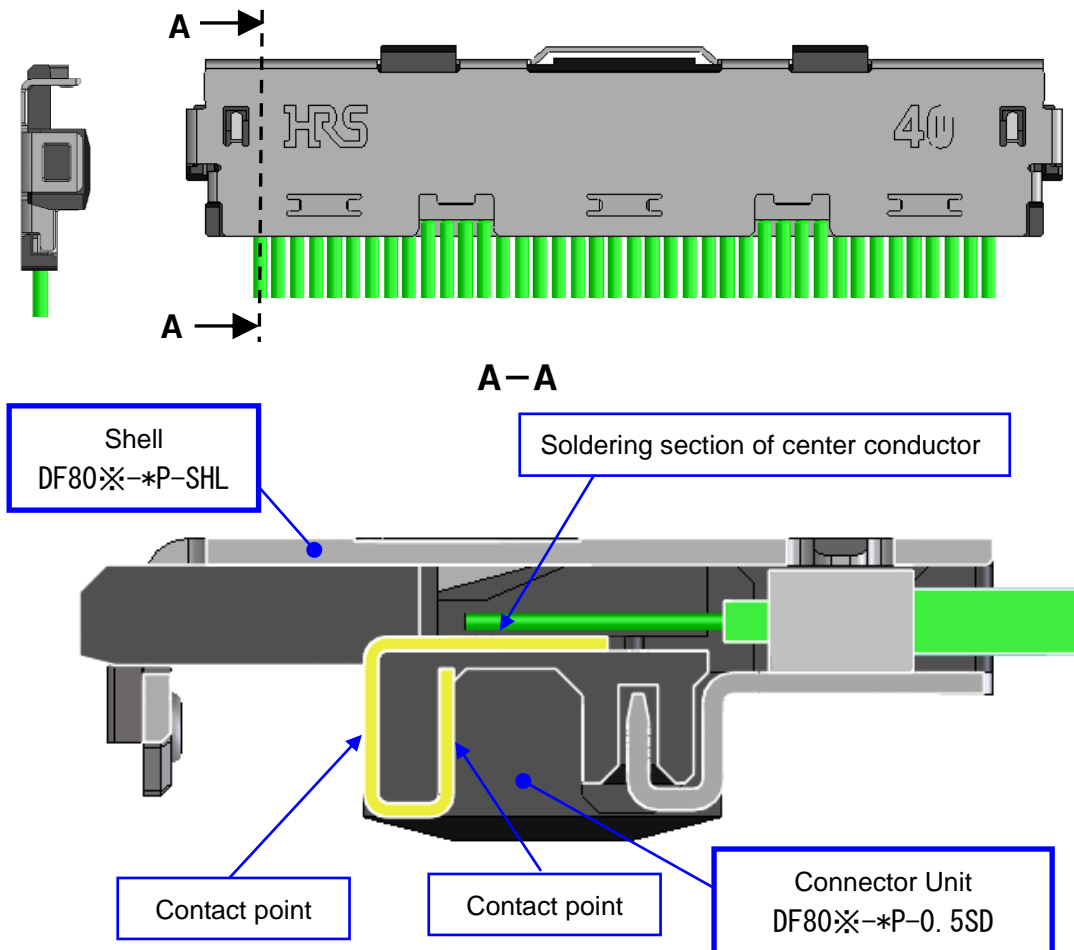

COUNT	DESCRIPTION OF REVISIONS	DESIGNED	CHECKED	DATE
2	DIS-D-00001218 (B)	DS. YAMAKOSHI	MH. TSUCHIDA	16. 06. 02
名称 TITLE		HIROSE ELECTRIC CO., LTD.		
DF80 Series Assembly Manual		APPROVED	TS. SAKATA	12. 07. 20
		CHECKED	TS. SAKATA	12. 07. 20
		DESIGNED	IO. DENPOUYA	12. 07. 20
		WRITTEN	IO. DENPOUYA	12. 07. 20
技術指定書 TECHICAL SPECIFICATION		ETAD-H0655		1 / 9

#### 4. Applicable Cable

Cable preparation as shown below is required prior to the cable assembly: (Figure below shows an example of alignment before cut.) 

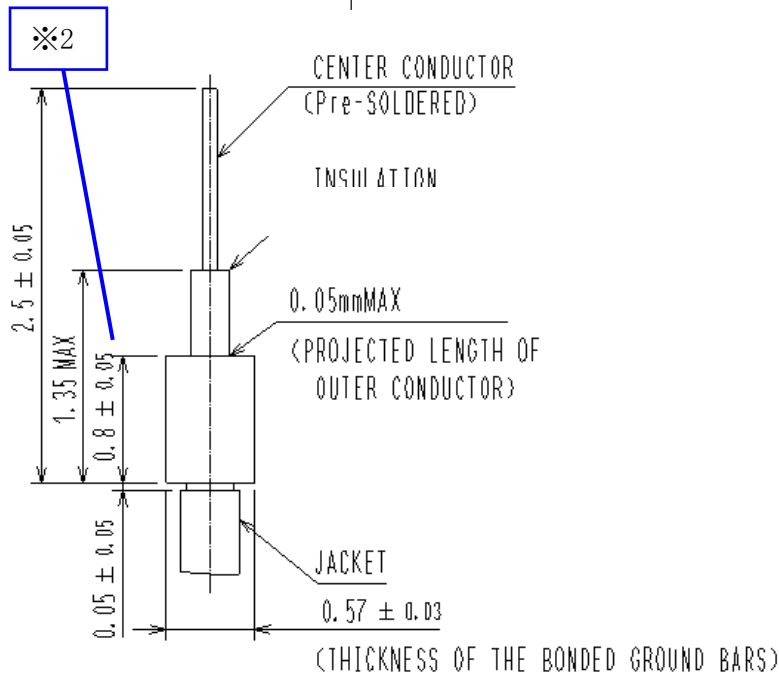
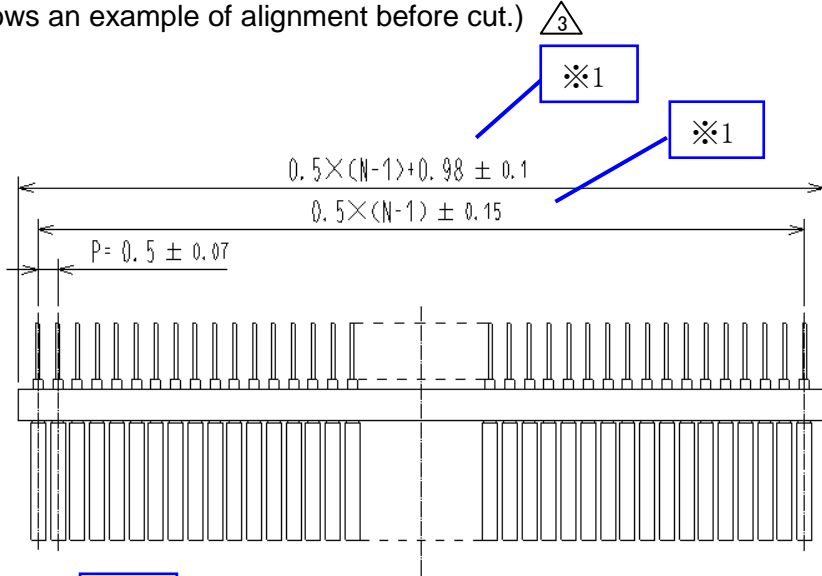

- Note : \*1 N means pin counts.
- Note : \*2 The dimension ( $0.8 \pm 0.05$ ) is the condition after bonding the ground bars.

## 5. Cable Assembly Procedure

An example of cable assembly process is shown below.

### 5-1. Cable Assembly Procedure

Procedure1: Soldering / Cable Placement



Procedure2: Soldering of the Center Conductor \* : Apply potting or polyimide tape if necessary.  
(refer to page 9)



Procedure3: Shell Assembly



Procedure4: Application of Solder Paste to The Shell



Procedure5: Soldering Shell and Connector Unit  
(Pulse heater)

5: Soldering Shell and Connector Unit  
(Manual soldering)



(Procedure6: pull-tab attachment) \* if it is necessary



Procedure7: Inspection

\* : Apply shielding tape if necessary.  
(refer to page 9)

### 5-2. Procedure1: Soldering / Cable Placement

Place wire solders and cables on the connector unit.

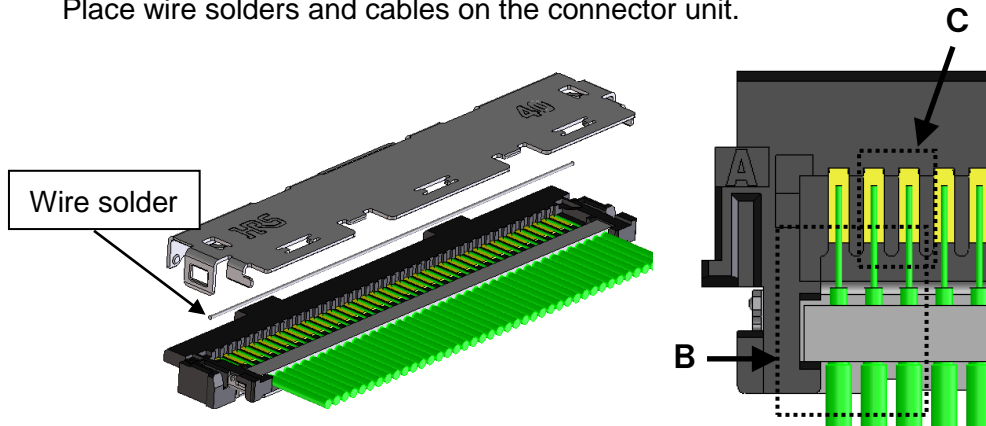

Recommended wire solder size :  $\varnothing 0.15$  Length:  $0.5 \times N$ mm (N=Pin counts)

● Note : \* 3 Place a ground bar to be in the area shown below.

#### Enlarged View of B

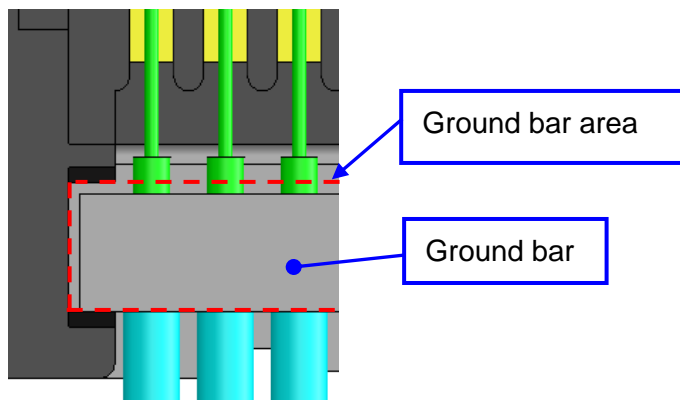

- Note : \* 4 Cable assembly with the center conductor extending from the contact width could cause short circuit by solder bridge and/or deterioration of withstanding voltage performance. Carry the withstanding voltage check and make sure that the result satisfies the performance specified by Hirose.

#### Enlarged View of C

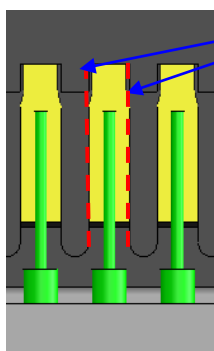

Withstanding voltage failure could occur if the center conductor extends from these lines.

#### 5-3. Procedure2: Soldering of the Center Conductor

Solder all the center conductors at the same time with pulse heater.

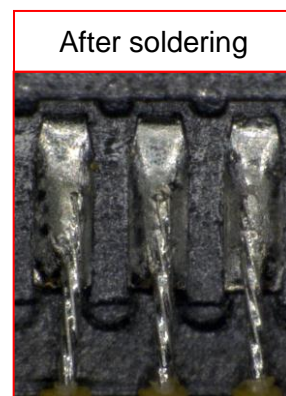
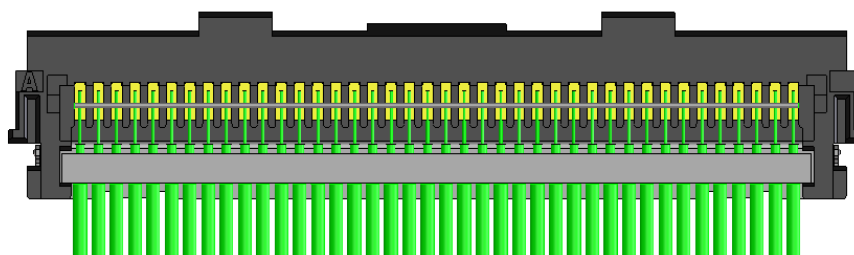

- Heat conditions for soldering  
 Method: Max 330 degree C up to 3 seconds / over 200 degree C up to 30 seconds  
 Requirement: No melting of the insulator

- Note : \*5 Make sure that the tip of the center conductor will not float as described in the following figure in order to prevent the short circuit after the shell (DF80#-\*P-SHL) assembly.

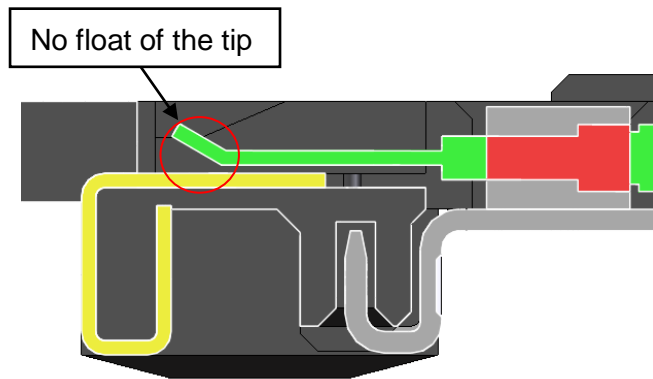

#### 5-4. Procedure3: Shell Assembly

Assemble the shell on the connector unit - No tool is require

- 5-4-1 Break the shell off from the carrier by bending up and down at the notches. (0° ⇒60° MAX⇒-60° )

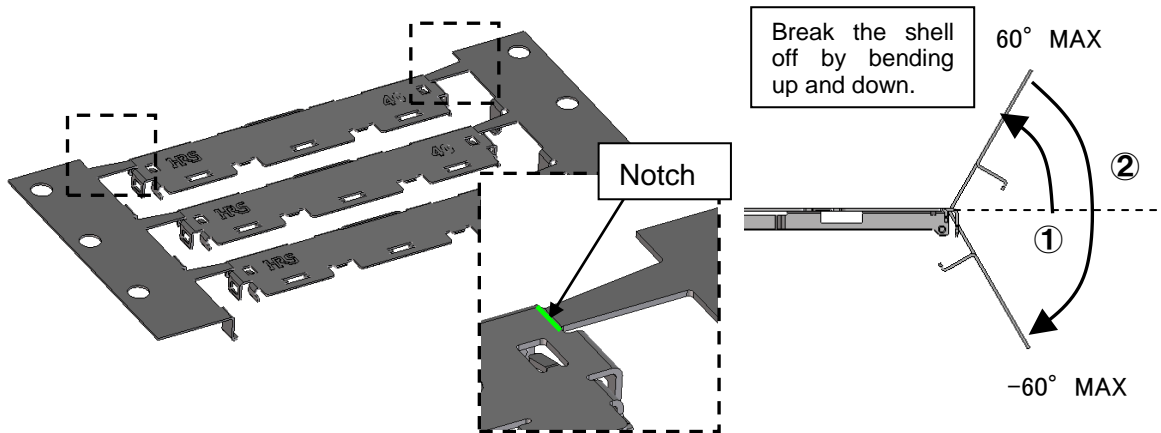



- Note : \*6

Do not bend over 60°, as breaking the notches of the shell by bending over 60° could generate burr at the broken edge.

In addition, if breaking the shell by bending over 60°, please confirm there is no burr.

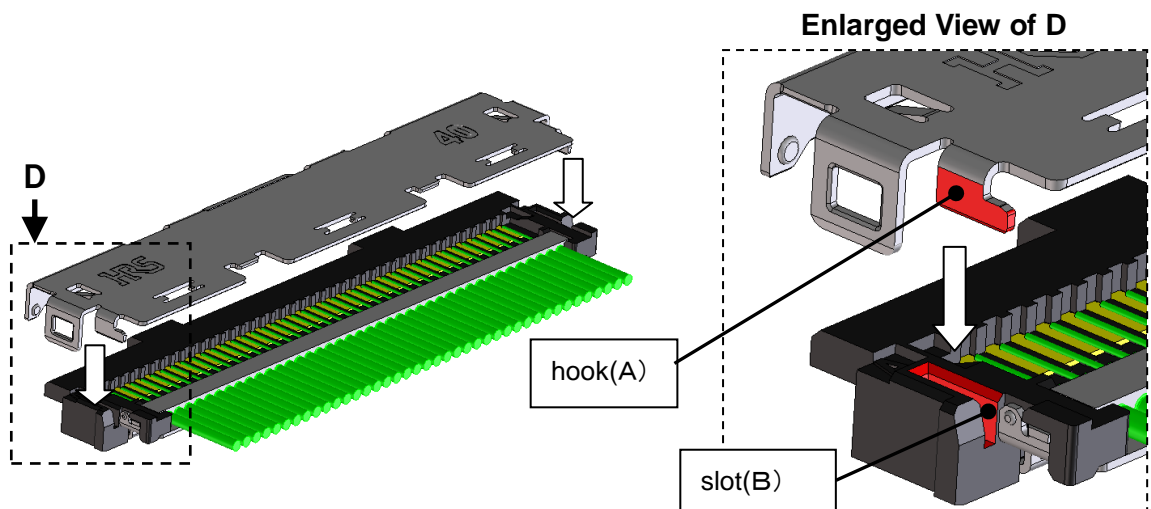
- 5-4-2. Insert the hook (A) of the shell into the slot (B) of the connector unit.



5-4-3. Slide the shell toward cable side as pressing the shell down to the connector unit. 

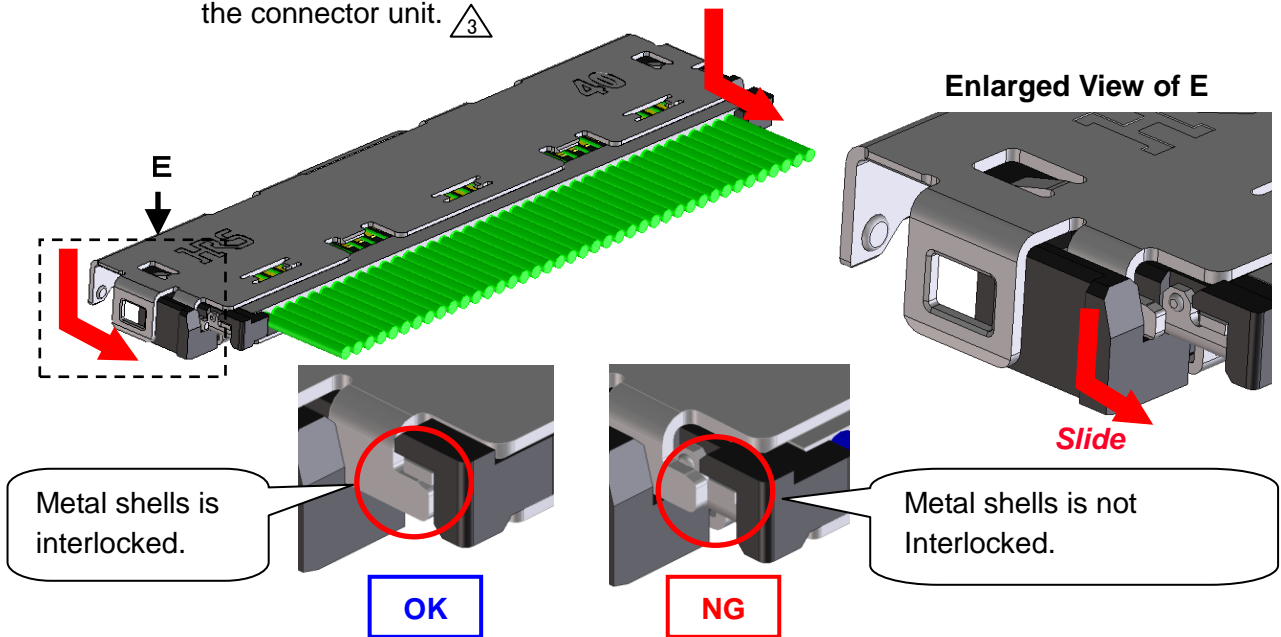

**※Note 7**

Make sure that the connector unit and the shell properly fit together as shown in below pictures.

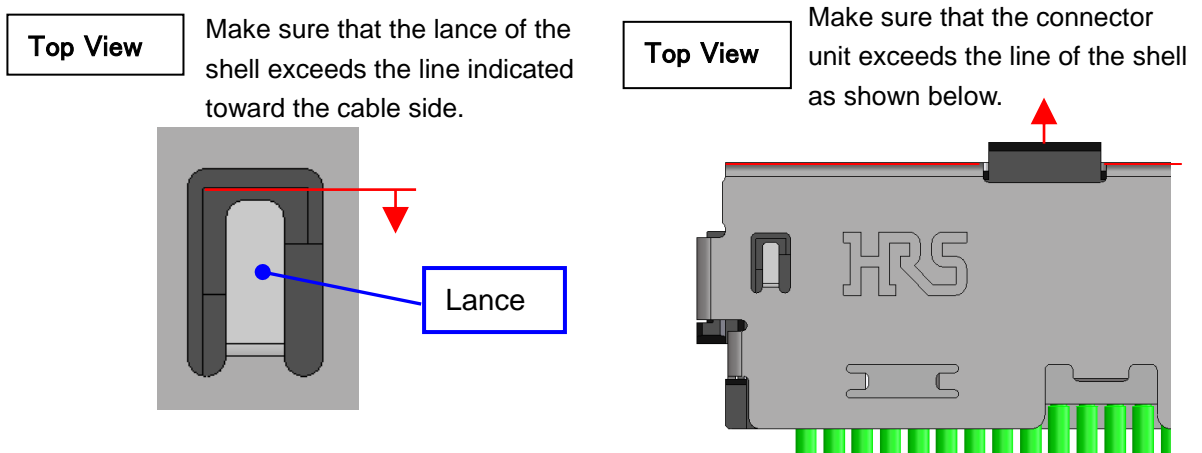

**5-5. Procedure5: Application of Solder Paste to The Shell**

Coat the opening of the shell with solder paste.(3 positions)

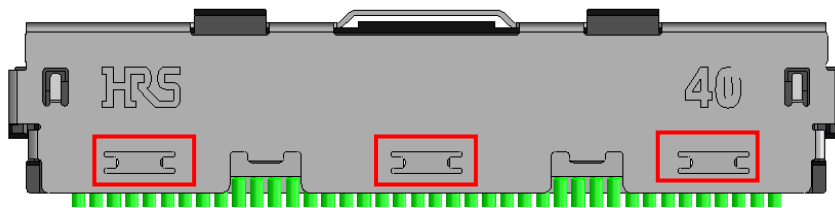

**5-6. Procedure 5: Soldering Shell and Connector Unit (Pulse heater)**

Solder the metal portions of the shell and the connector unit. (3 positions)

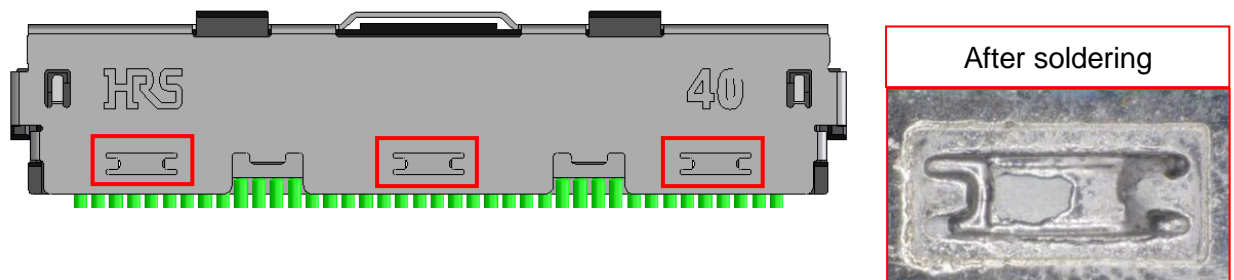

**5-7. Procedure 5: Soldering Shell and Connector Unit (Manual soldering)**  
 Solder the metal portions of the shell and the connector unit. (2 positions)

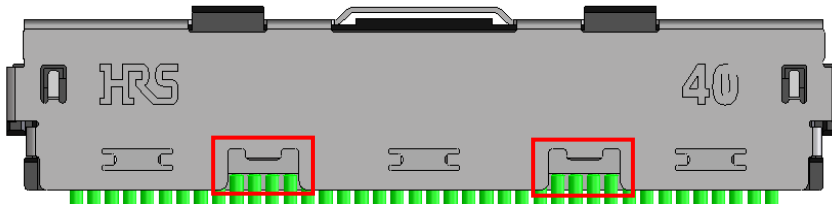

**5-8. (Procedure 6: pull-tab attachment)**

In case a pull-tab is necessary, please follow below procedures.

※ The design of the pull-tab is an example.

Dimensions and material written inside ( ) are for reference.

5-8-1. Pass the pull-tab through a pull-tab-Slit on the shell.

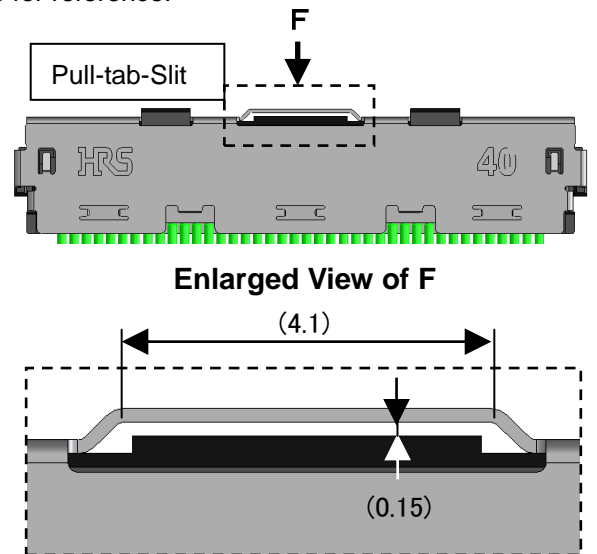
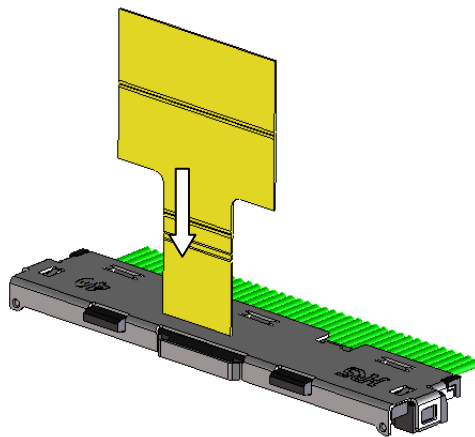

5-8-2. Fold the pull-tab back as indicated with arrows and in the specified order.

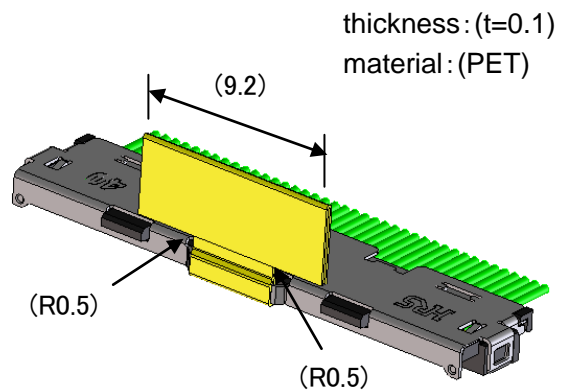
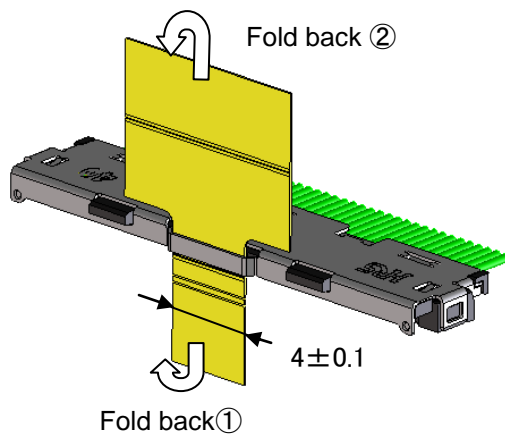

※**Note8**

Excessively loose-fitting pull-tab could be pinched during mating and cause contact failure.

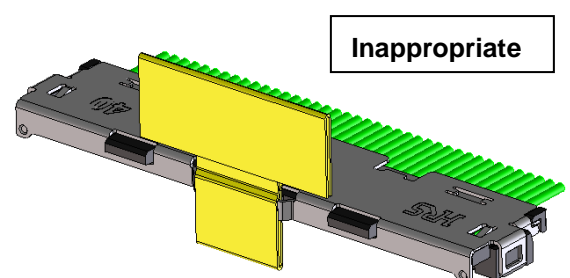
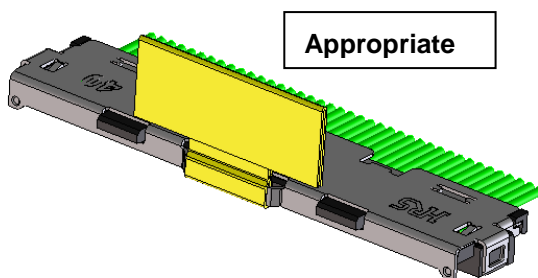

5-8. Procedure7: Finished Dimension

Finished dimension is shown below.

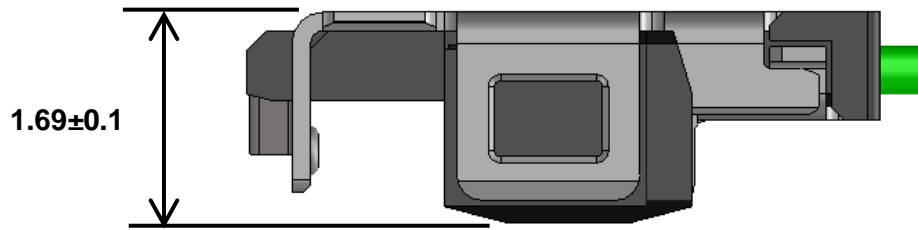

5-9. Procedure7: Inspection

Check the continuity and the voltage proof to verify that the product satisfies the performance as specified in our specification sheet.

■ SPECIFICATION SHHET ELECTRIC CHARACTERISTICS

INSULATION RESISTANCE	50MΩ MIN
VOLTAGE PROOF	NO FLASHOVER OR BREAKDOWN UNDER AC150 V, FOR 1 MINUTE.



### Area of Resin sealing or polyimide tape attachment

Resin sealing or polyimide tape attachment is allowed to the area indicated as shown.

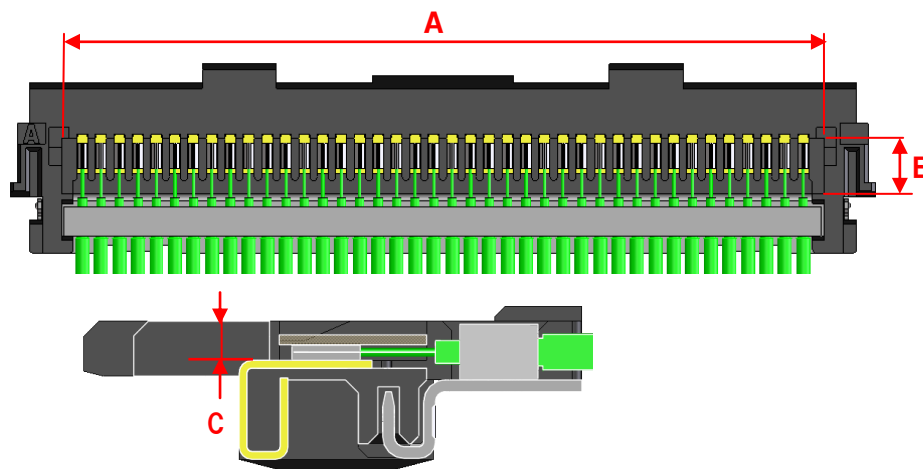

Size list

contact	A	B ※1	C ※2
30P	10.5mm	1.45mm	0.4mm
40P	15.5mm		
45P	18.0mm		
50P	20.5mm		

※1: Please contact us for the dimension C of DF80D-\*P-0.5SD with cable alignment guide design, as the dimension is different.

※2: Note that the dimension includes the height of cable conductor and solder fillet, and select the tape to satisfy the dimension.

### Area of shielding tape attachment

Shielding tape attachment is allowed to the area indicated as shown.

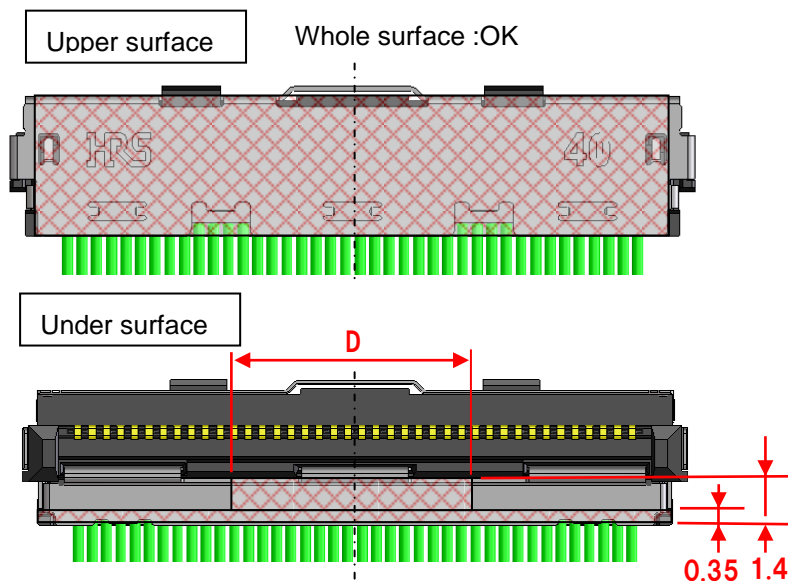

Size list

contact	D
30P	4.0mm
40P	9.0mm
45P	11.5mm
50P	14.0mm