

Dec.1.2024 Copyright 2024 HIROSE ELECTRIC CO., LTD. All Rights Reserved.
In case of consideration for using Automotive equipment / device which demand high reliability, kindly contact our sales window correspondents.

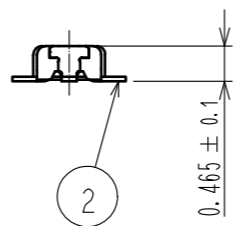

ENGAGEMENT FIGURE (20:1)

5 RECOMMENDED REFLOW TEMPERATURE PROFILE USING LEAD-FREE SOLDER PASTE.

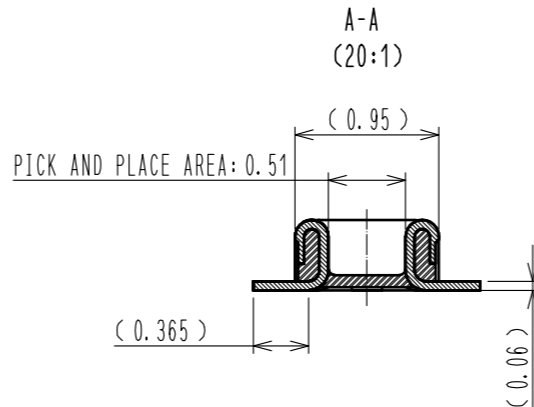
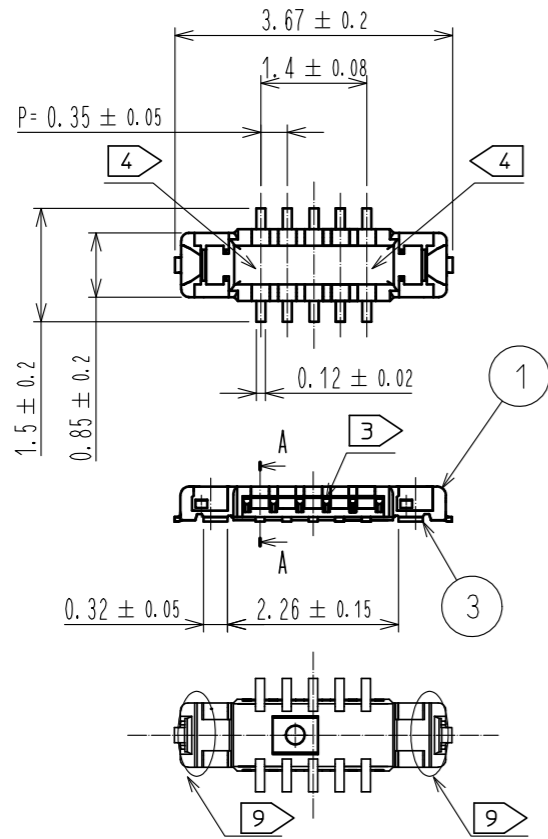
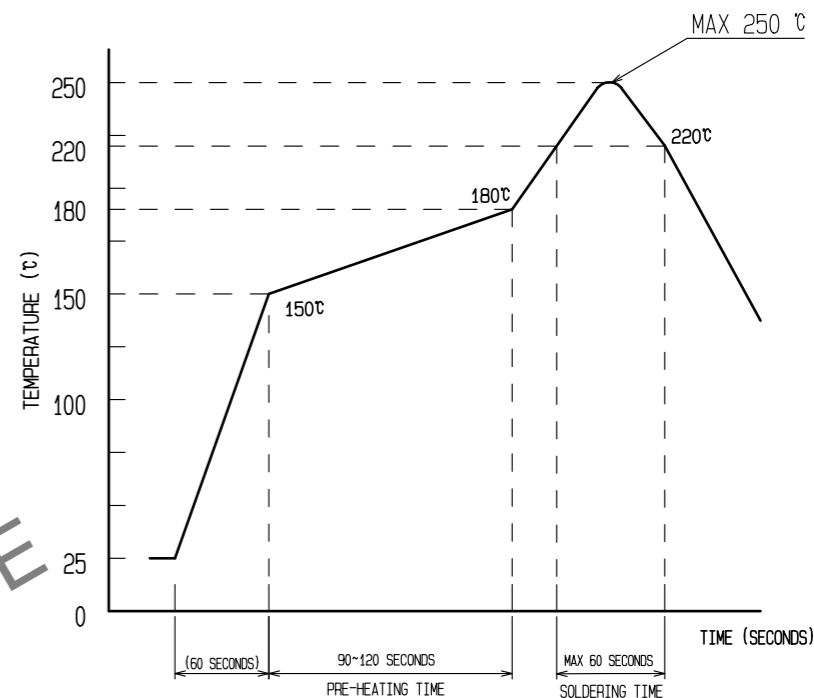

REFLOW METHOD: IR REFLOW
 NUMBER OF REFLOW CYCLES: 2 CYCLES MAX.
 1) REFLOW TIME
 DURATION ABOVE 220°C: 60 SEC MAX.
 (PEAK TEMPERATURE: 250°C MAX)
 2) PRE-HEAT TIME
 PRE-HEAT TEMPERATURE (MIN): 150°C
 PRE-HEAT TEMPERATURE (MAX): 180°C
 PRE-HEAT TIME: 90-120 SEC.

5 THIS TEMPERATURE PROFILE IS PER THE CONDITIONS SHOWN ABOVE. ADDITIONAL FACTORS, SUCH AS SOLDER PASTE TYPE, PCB SIZE AND OTHER MOUNTED COMPONENTS COULD AFFECT THE PROFILE. THEREFORE, A THOROUGH EVALUATION OF MOUNTING COONDITION IS REQUIRED PRIOR TO PRODUCTION. TEPERATURE IS MEASURED AT CONTACT LEAD.
 6. PLEASE CONTACT US IN CASE YOU WILL MAKE DIFFERENT SETTINGS FROM OUR RECOMMENDATION.
 7. THIS PRODUCT SATISFIES HALOGEN FREE REQUIREMENTS DEFINED AS 900ppm MAXIMUM CHLORINE, 900ppm MAXIMUM BROMINE, AND 1500ppm MAXIMUM TOTAL OF CHLORINE AND BROMINE.
 8. THIS PRODUCT COMPLY WITH ROHS.
 9 WELD LINE APPEARS IN THE INDICATED AREA.

NOTE 1 . ALL LEAD CO-PLANARITY SHALL BE 0.08mm MAX.

- 2 CONTACT PLATING SPECIFICATIONS
 CONTACT AREA : GOLD 0.05 μm MIN
 SMT LEAD : GOLD 0.05 μm MIN
 UNDER PLATING : NICKEL 1 μm MIN
 (SURFACE : SEALING)
- 3 A PART OF THE WALL COULD BE NOTCHED.
- 4 CAV NO. AND HRS MARK EXIST IN THE INDICATED POSITION.

◆ RECOMMENDED PCB LAYOUT (LAND PATTERN)

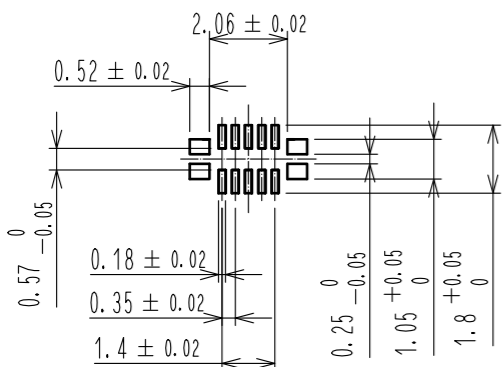

◆ RECOMMENDED METAL MASK DIMENSIONS
 METAL MASK THICKNESS : 80 μm

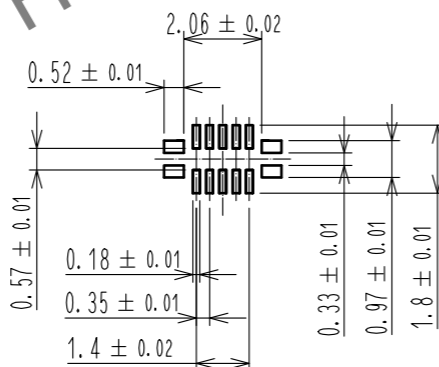

◆ RECOMMENDED PCB LAYOUT (ALLOCATION AROUND CONNECTOR)

NO COMPONENTS, AND NO CONDUCTIVE TRACES AND VIAS FOR OTHER COMPONENTS, WHICH WOULD INTERFERE WITH RECEPTACLE

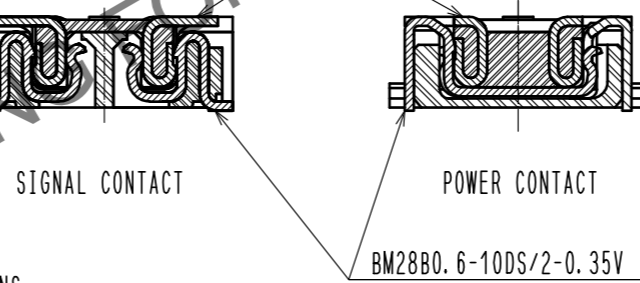
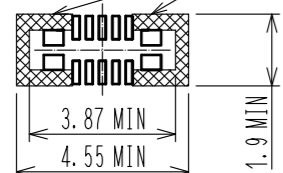

4	PS	CLEAR(EMBOSSED CARRIER TAPE)					
3	COPPER ALLOY	2	7	PS	CLEAR(REINFORCEMENT COLLAR)		
2	COPPER ALLOY	2	6	PS	BLACK(PLASTIC REEL)		
1	LCP	UL94 V-0, BLACK	5	POLYESTER	CLEAR(COVER TAPE)		
NO.	MATERIAL	FINISH . REMARKS	NO.	MATERIAL	FINISH . REMARKS		
UNITS mm		SCALE 10:1	COUNT 3	DESCRIPTION OF REVISIONS DIS-H-00010194	DESIGNED KH. ODA	CHECKED TS. MIYAZAKI	DATE 20210714
HRS HIROSE ELECTRIC CO., LTD.		APPROVED : MO. ISHIDA	20150715	DRAWING NO. EDC-365297-51-01			
		CHECKED : TS. MIYAZAKI	20150714	PART NO. BM28B0.6-10DP/2-0.35V(51)			
		DESIGNED : YK. SATAKE	20150714	CODE NO. CL0673-5043-0-51			
		DRAWN : KR. AJITO	20150714	1/3			

Dec.1.2024 Copyright 2024 HIROSE ELECTRIC CO., LTD. All Rights Reserved.
 In case of consideration for using Automotive equipment / device which demand high reliability, kindly contact our sales window correspondents.

EMBOSSED CARRIER TAPE PACKAGING (5:1)

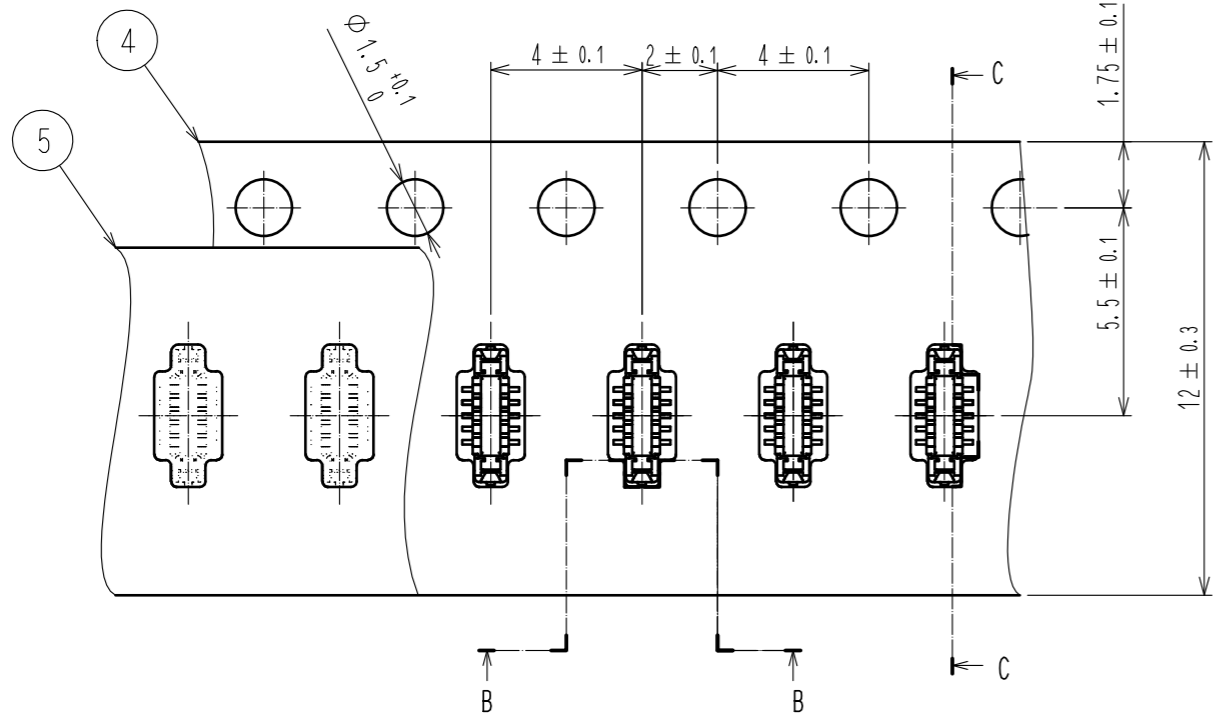

C-C (5:1)

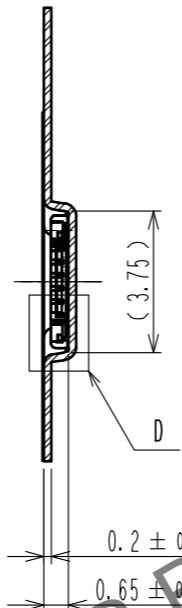

DIRECTION OF UNREELING

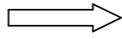

B-B (5:1)

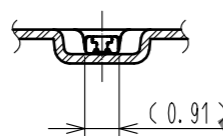

STYLE AND DIMENSION OF REEL (FREE)

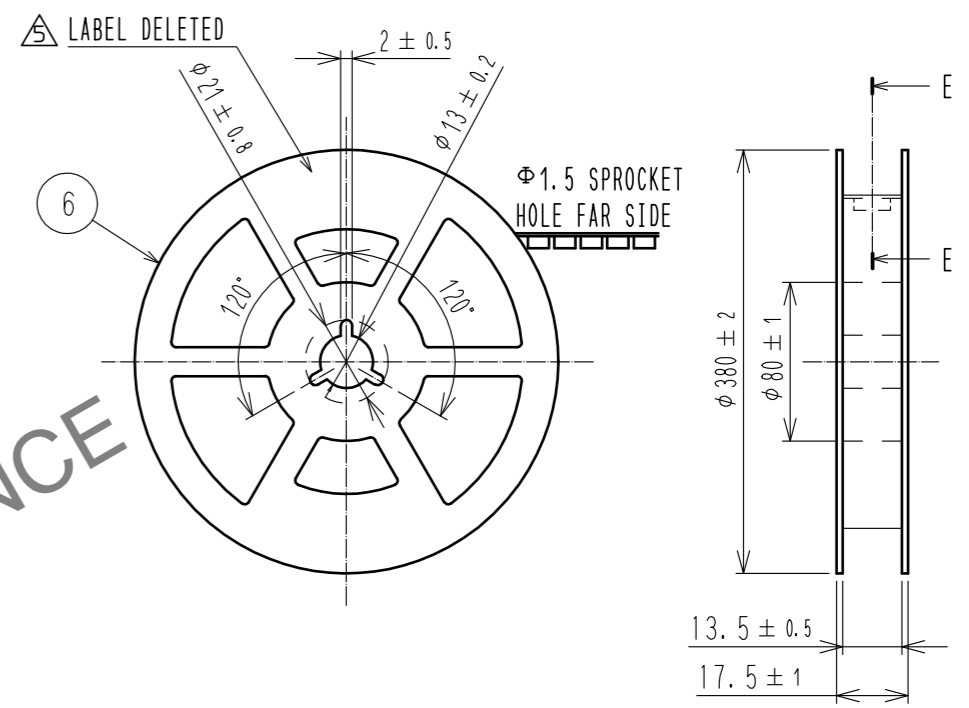

E-E (FREE)

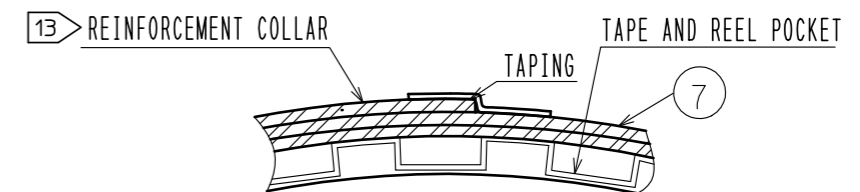

D (10:1)

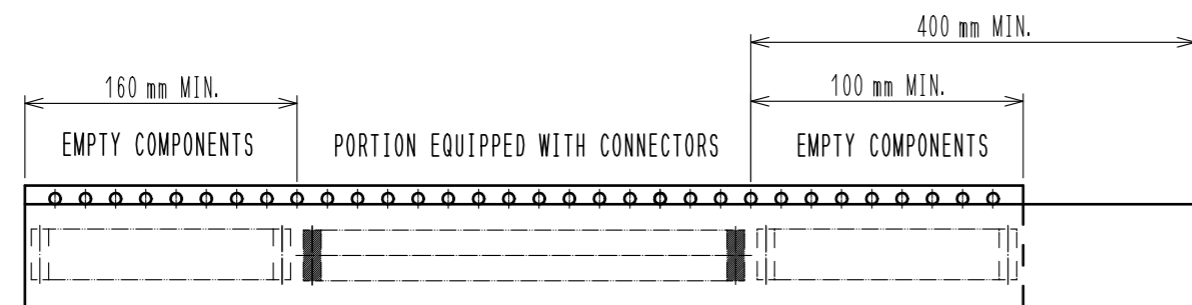
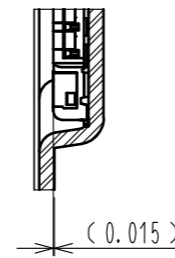

TRAILER

TAPING (FREE)

LEADER

△ LABEL DELETED

- 10 . PER REEL 20,000 CONNECTORS.
- 11 . THE DIMENSIONS IN PARENTHESES ARE FOR REFERENCE.
- 12 . REFER TO JIS C 0806, IEC 60286-3(PACKAGING OF COMPONENTS FOR AUTOMATIC HANDLING)
- 13 . AFTER PACKAGING, ROLL 2 METERS OF THE REINFORCEMENT COLLAR TO OUTER CIRCUMFERENCE OF TAPE AND REEL POCKET. AND TAPE DOWN AT THE END THE COLLAR.

HRS	DRAWING NO.	EDC-365297-51-01		
	PART NO.	BM28B0. 6-10DP/2-0. 35V(51)		
	CODE NO.	CL0673-5043-0-51	△	2/3

Dec.1.2024 Copyright 2024 HIROSE ELECTRIC CO., LTD. All Rights Reserved.
In case of consideration for using Automotive equipment / device which demand high reliability, kindly contact our sales window correspondents.

△14. PLEASE REFER TO THE PRODUCT GUIDELINE ETAD-H1016 FOR DETAIL OF CONNECTOR HANDLING.

THE POSITION BETWEEN THE CONNECTOR AND PAD

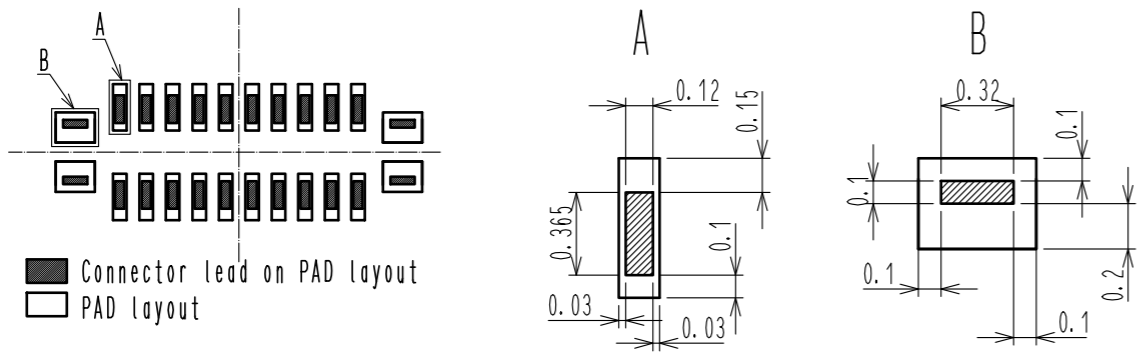

MATING METHOD

PLEASE MATE THE CONNECTOR BY HAND.

MATING PROCEDURE

- (1) FIND THE ALIGNMENT AREA TO THE CONNECTOR IN THE APPROPRIATE MATING POSITION.
THIS CONNECTOR HAS AN ALIGNMENT CHAMBER(GUIDANCE RIBS) ON RECEPTACLE SIDE AND 'R' ON PLUG SIDE.
SO THAT THE CONNECTOR WILL BE SELF-ALIGNED.
WHEN THE CONNECTOR COMES TO THE APPROPRIATE POSITION, THE CONNECTOR GOES INTO THE ALIGNED POSITION.
WHEN ALIGNED, IT CAN BE FELT BY HAND.

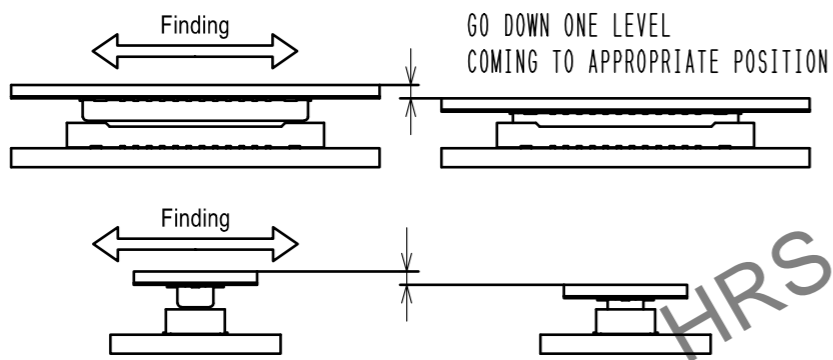

- (2) WHEN GUIDING, THE CONNECTORS ARE ALIGNED PARALLEL TO EACH OTHER, WITH LONGITUDINAL AND LATERAL MOVEMENTS RESTRICTED. MATE THEM PROPERLY BY APPLYING FORCE IN THIS CONDITION.



- (3) MAKE SURE THE CONNECTORS ARE MATED CORRECTLY. IF ONE SIDE IS FLOATING OR THE CONNECTORS ARE MATED IN ONE DIRECTION, UN-MATE THEM ONCE, AND THEN MATE THEM AGAIN, FOLLOWING THE PROCEDURES ABOVE FROM THE BEGINNING.

UN-MATING METHOD

PLEASE UN-MATE THE CONNECTOR BY HAND

- (1) UN-MATE THE CONNECTORS PARALLEL TO EACH OTHER. HOWEVER, IF THE CONNECTORS HAVE HIGH PIN COUNTS OR THINNER FPC AND STIFFENER, IT BECOMES MORE DIFFICULT TO DO SO.

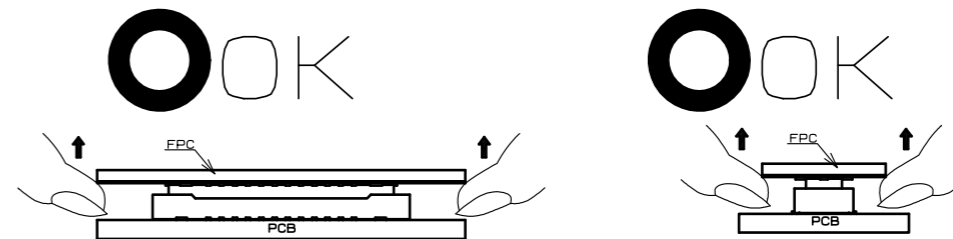

- (2) IF THE CONNECTOR CANNOT BE UN-MATED PARALLEL IT CAN BE REMOVED DIAGONALLY FROM THE PITCH DIRECTION. BE CAREFUL TO DO SO SINCE THIS ACTION APPLIES STRESS ON THE CONTACT.

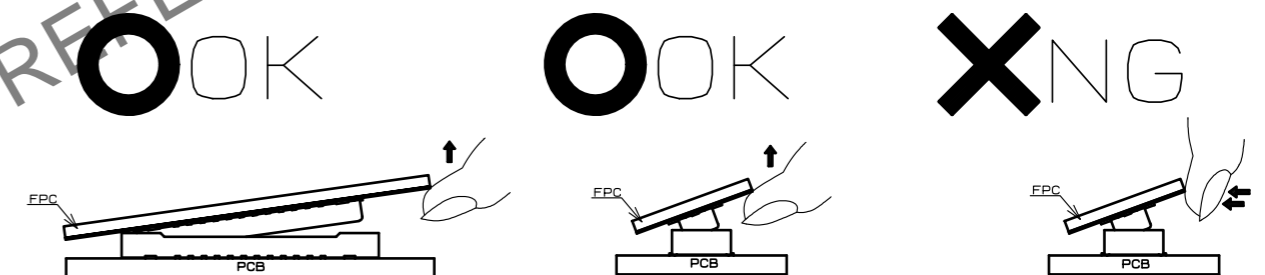

- (3) IF THE FPC IS NOT RIGID, THE CONNECTOR CAN BE BROKEN. PLEASE CHECK THE ACTION OF THE FPC TO BE USED REPEATEDLY AT THE TIME OF TRIAL PRODUCTION. BE CAREFUL TO UN-MATE THEM FROM THE PITCH DIRECTION, PULLING IT FROM THE CORNER CAN ALSO RISK TO PUTTING STRESS ON CONTACTS.

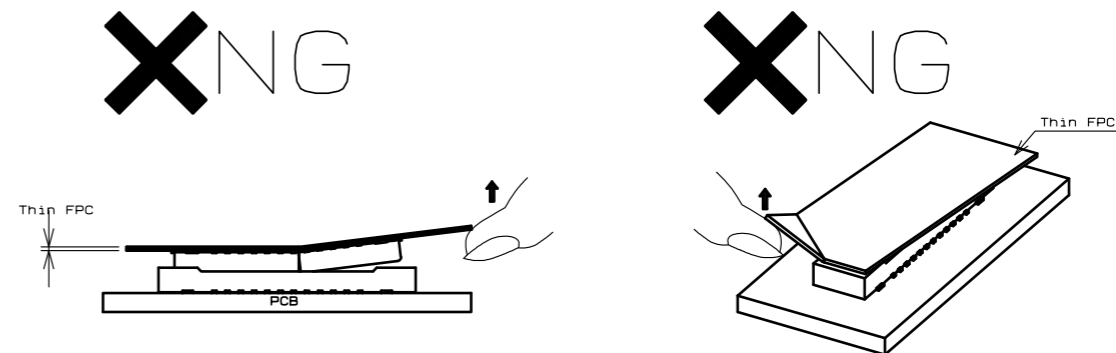

HRS	DRAWING NO.	EDC-365297-51-01
	PART NO.	BM28B0.6-10DP/2-0.35V(51)
	CODE NO.	CL0673-5043-0-51
		△ 3/3