

Oct.1.2024 Copyright 2024 HIROSE ELECTRIC CO., LTD. All Rights Reserved.
 In case of consideration for using Automotive equipment / device which demand high reliability, kindly contact our sales window correspondents.

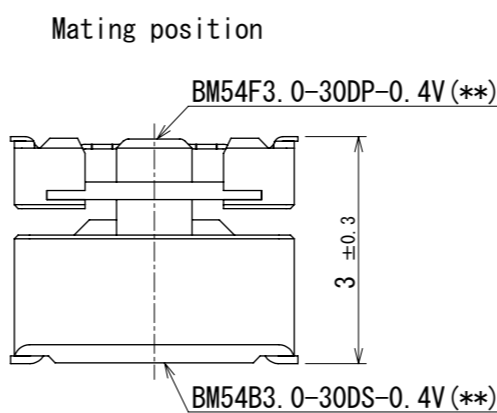

8 Recommended reflow temperature profile using lead-free solder paste.

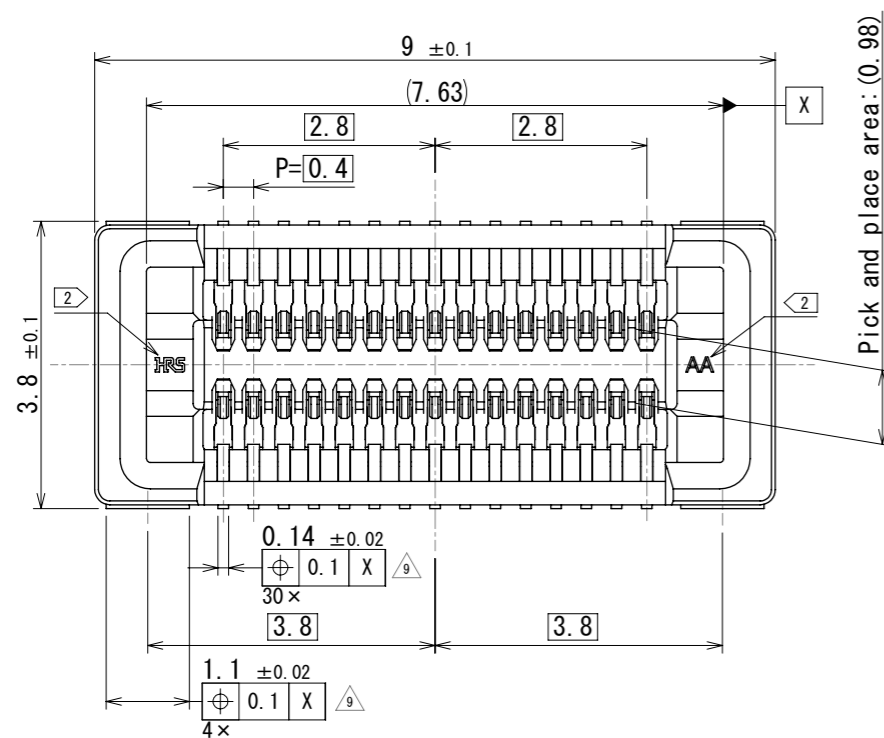
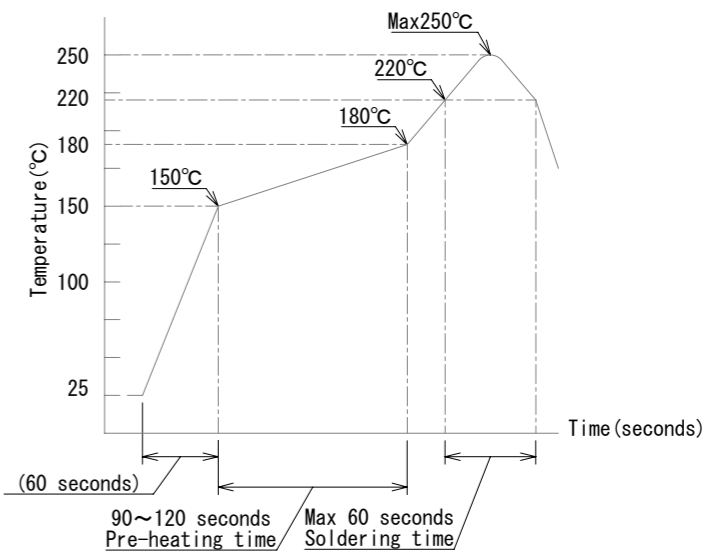

Reflow method : IR reflow
 Number of reflow cycles : 2 cycles max.
 1) Reflow time : Duration above 220°C, 60 sec max. (peak temperature : 250°C max)
 2) Pre-heat time : Pre-heat temperature (min) : 150°C, Pre-heat temperature (max) : 180°C, Pre-heat time : 90-120 sec.

- Note
- All lead co-planarity will be 0.1mm max.
 - HRS mark and cavity number are indicated at approximate location.
 - Plating specifications
 Contact area : Gold 0.05 μm min
 SMT lead : Gold 0.05 μm min
 Under plating : Nickel 1 μm min
 (Surface : Sealing)
 - The dimensions in parentheses are only for reference.
 - This product satisfies halogen free requirements defined as 900ppm max chlorine, 900ppm max bromine, and 1500ppm max total of chlorine and bromine.
 - This product complies with RoHS.
 - This temperature profile is based on the suggested metal mask and footprint. Please contact us if using different settings from our recommendation.

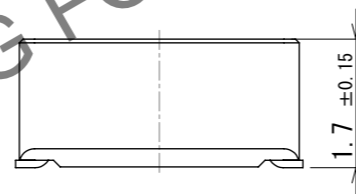
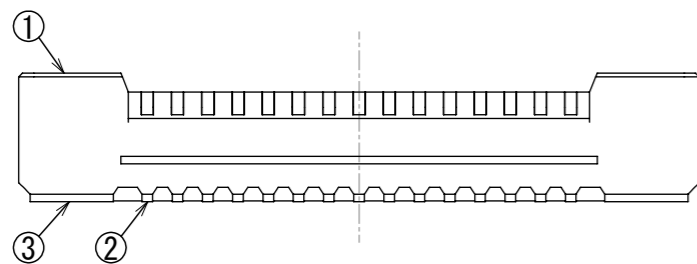

Recommended PCB dimensions (5:1)

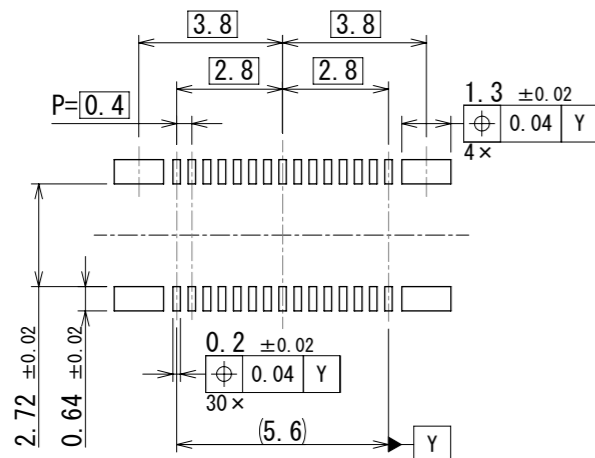

Recommended metal mask dimensions (5:1)
 Metalmask thickness : 100 μm

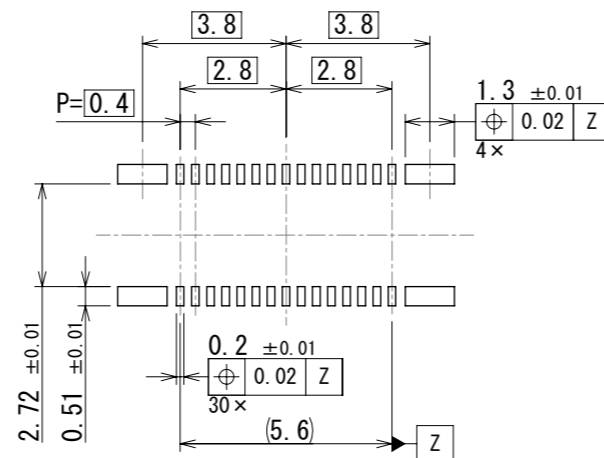

3	Copper alloy			7	PS	Clear, Reinforcement collar				
2	Copper alloy			6	PS	Black, Plastic reel				
1	LCP	Black		5	Polyester	Clear, Cover tape				
				4	PS	Clear, Embossed carrier tape				
NO.	MATERIAL	FINISH	REMARKS	NO.	MATERIAL	FINISH	REMARKS			
UNITS	mm		SCALE	10:1	COUNT	2	DESCRIPTION OF REVISIONS	DESIGNED	CHECKED	DATE
HRS			HIROSE ELECTRIC CO., LTD.		APPROVED : WR. FUKUCHI 2021.11.24		DRAWING NO. EDC-394716-51-00		2024.07.11	
					CHECKED : TY. OOI 2021.11.24		PART NO. BM54B3.0-30DS-0.4V (51)			
					DESIGNED : YK. KOBAYASHI 2021.11.22		CODE NO. CL0684-4602-0-51			
					DRAWN : YK. KOBAYASHI 2021.11.22					

Oct.1.2024 Copyright 2024 HIROSE ELECTRIC CO., LTD. All Rights Reserved.
 In case of consideration for using Automotive equipment / device which demand high reliability, kindly contact our sales window correspondents.

1 2 3 4 5 6 7 8

Embossed carrier tape packaging (5:1)

Style and dimension of reel (free)

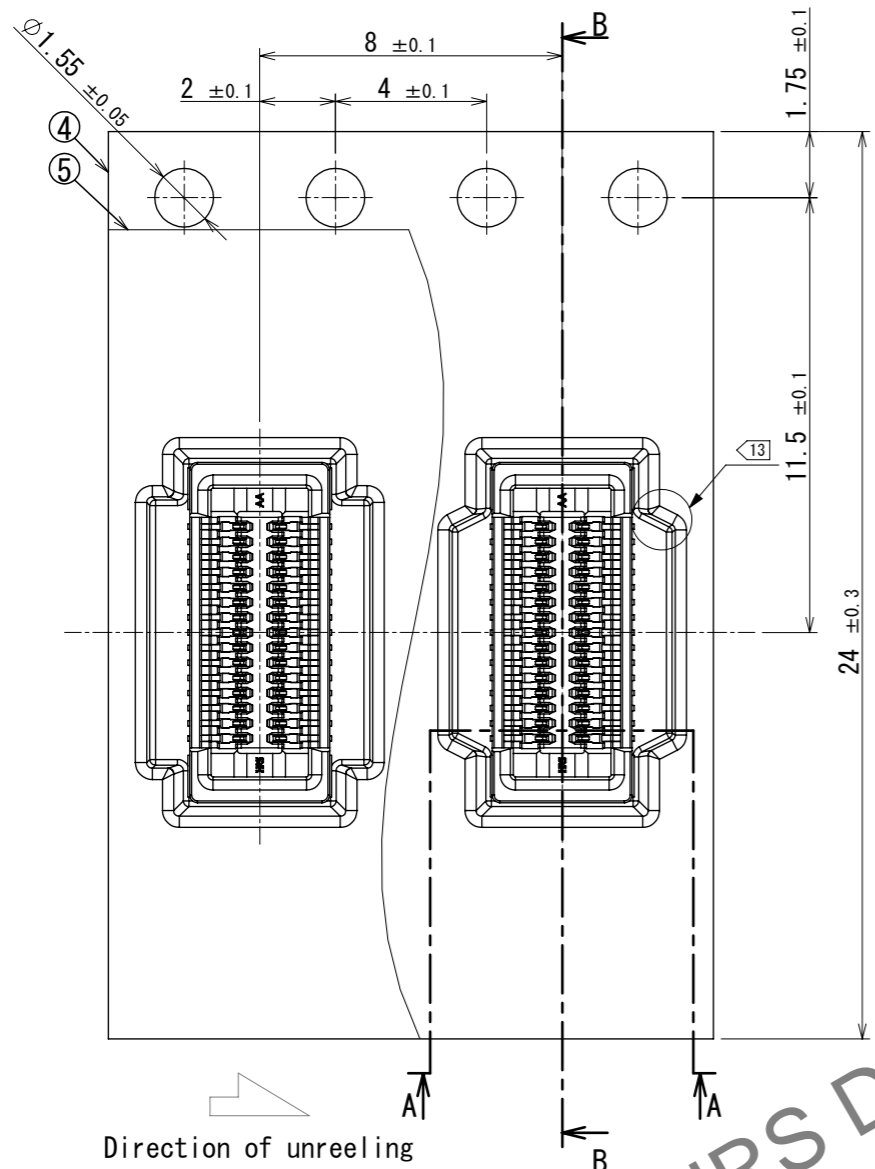

B-B
(5 : 1)

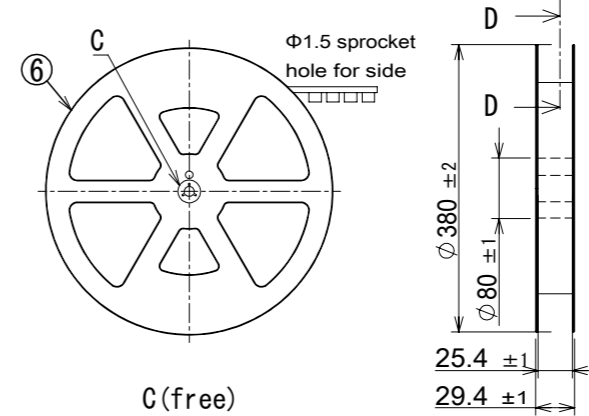

C (free)

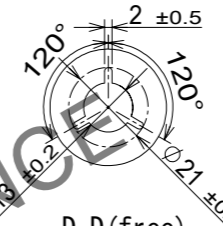

D-D (free)

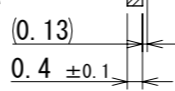
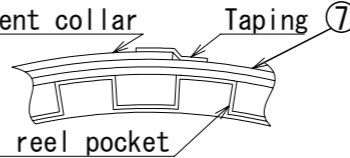

- 9 . 4,000 connectors per reel.
- 11. Refer to IEC 60286-3 (packaging of components for automatic handling)
- 12. The reinforcing collar is wrapped around the emboss tape and taped down at the end of the collar.
- 13. Some of the pockets may have a different shape.

Direction of unreeling

A-A
(5 : 1)

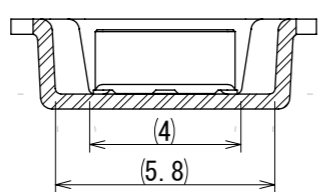

11. Taping (free)

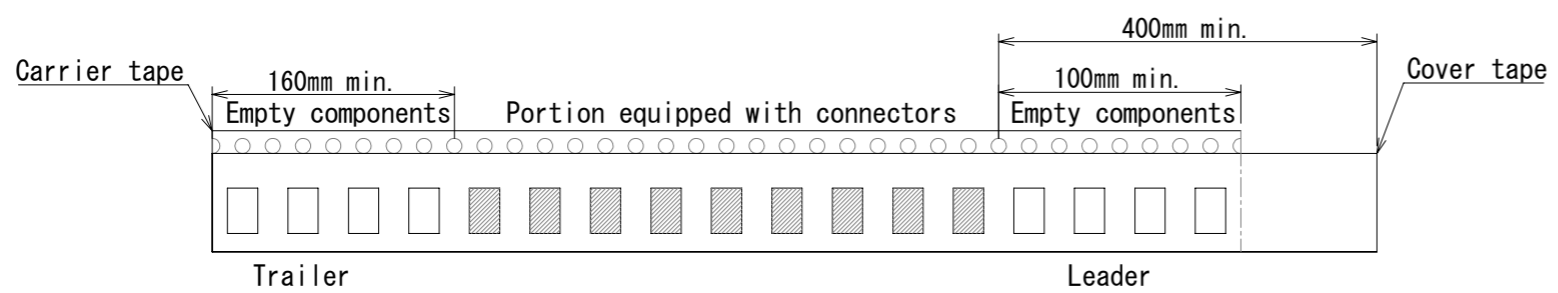

HRS	DRAWING NO.	EDC-394716-51-00	2/3
	PART NO.	BM54B3. 0-30DS-0. 4V (51)	
	CODE NO.	CL0684-4602-0-51	
	NO.		

Oct.1.2024 Copyright 2024 HIROSE ELECTRIC CO., LTD. All Rights Reserved.
In case of consideration for using Automotive equipment / device which demand high reliability, kindly contact our sales window correspondents.

14. Please refer to the product guideline for detail of connector handling.

The position between the connector and PAD

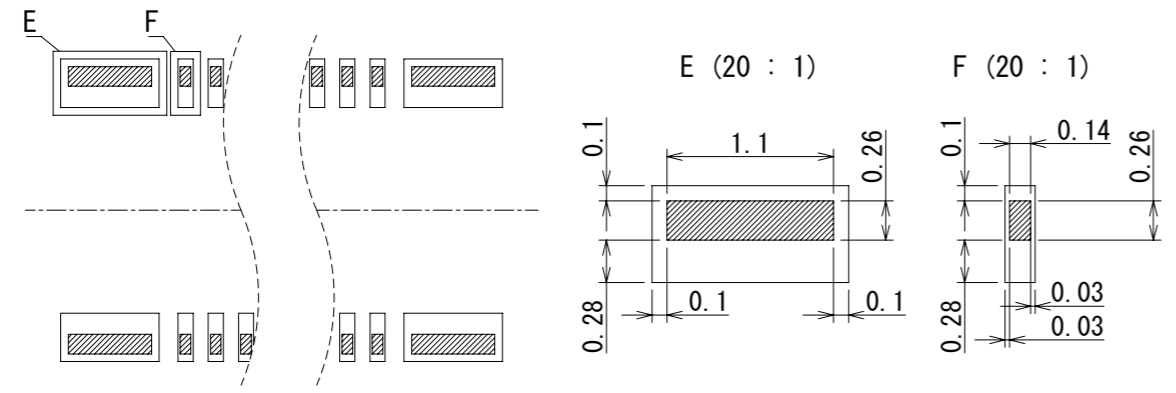

▨ Connector lead on PAD layout
□ PAD layout

Connector area

(1) ▨ is connector area or floating area, if other parts enter this area, it is possible to affect floating performance.

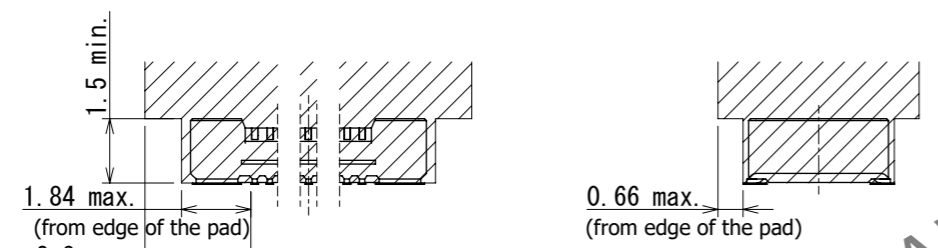

▨ Connector area
■ PAD

Mating method

(1) The alignment dimension is ± 0.4 mm in the X and Y directions. After the start of mating, follow the alignment and mate perpendicularly to the board without applying an overloading to the connector

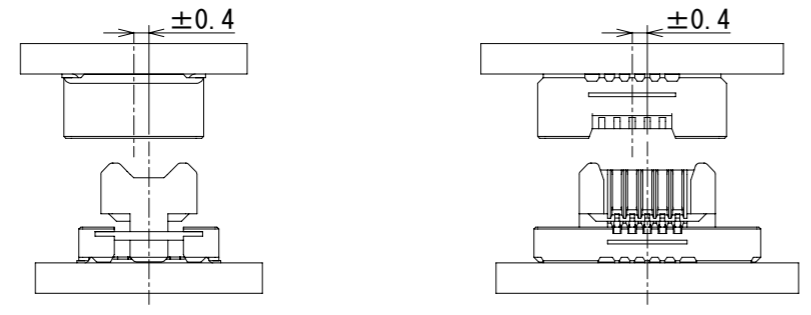

Misalignment Allowance in Mated Condition (Floating Range)

(1) Because of floating design, this connector has a ± 0.4 mm board misalignment tolerance in the X and Y directions when mated. However, it is not suitable for absorption when the range of misalignment constantly changes due to vibration, etc. The number of repetitions of floating movable operations is stipulated to be no more than 10 times



Securing PCBs

(1) This connector can absorb misalignment between PCBs, but not vibration. If you support PCBs only with the connectors without taking any fixing measures, the load on the connectors will be excessive and may cause broken or contact failure. Be sure to secure PCBs except for the connectors as shown below to prevent the board from moving. This connector connects the board to the board. When using mounting to FPC, fasten the board and FPC to the case separately



Fixing PCBs with a spacer or case

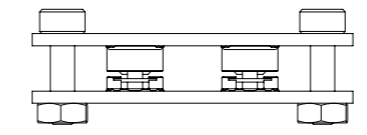

Do not use the product without fixing PCBs together.

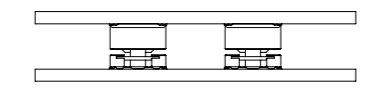

Un-mating method

(1) Un-mate the connectors parallel to each other.

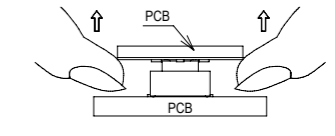
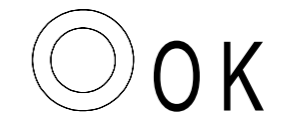
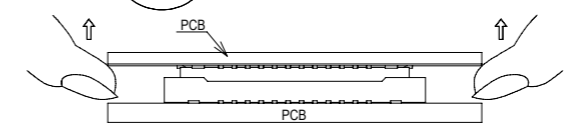

(2) When un-mating the connector, pull it out in parallel. If it is un-mated in an inclined position, connector may deform.

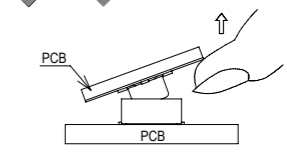
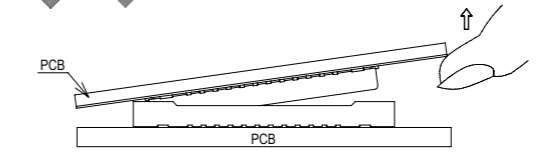

HRS	DRAWING NO.	EDC-394716-51-00	3/3
	PART NO.	BM54B3. 0-30DS-0.4V (51)	
	CODE NO.	CL0684-4602-0-51	
	NO.		