

1. Scope

This document specifies the cable assembly procedures of crimping the crimp contact to the cable and inserting the contact to the crimp case for DF52 Series.

2. Part Number

Part No.	Description	Remarks
DF52-2832PCF(##)	Crimp contact	Compatible cables : AWG28 to 32
DF52-*P-0.8C(##)	Crimp case	

*: Number of position, (##): Peculiar specification number

3. Cable Assembly Procedure

3.1. Cable Stripping

Follow the Crimping Quality Standard (ATAD-H0789), and strip the cable jacket. Make sure that there is no damage on the center conductor of the cable.



3.2. Crimping Process

Crimp the contact by using the applicator (AP105-DF52-2832P). Confirm that the crimp height and configuration meet the crimp condition and Crimping Quality Standard (ATAD-H0789).

3.3. Crimped Contact Insertion to Crimp Case

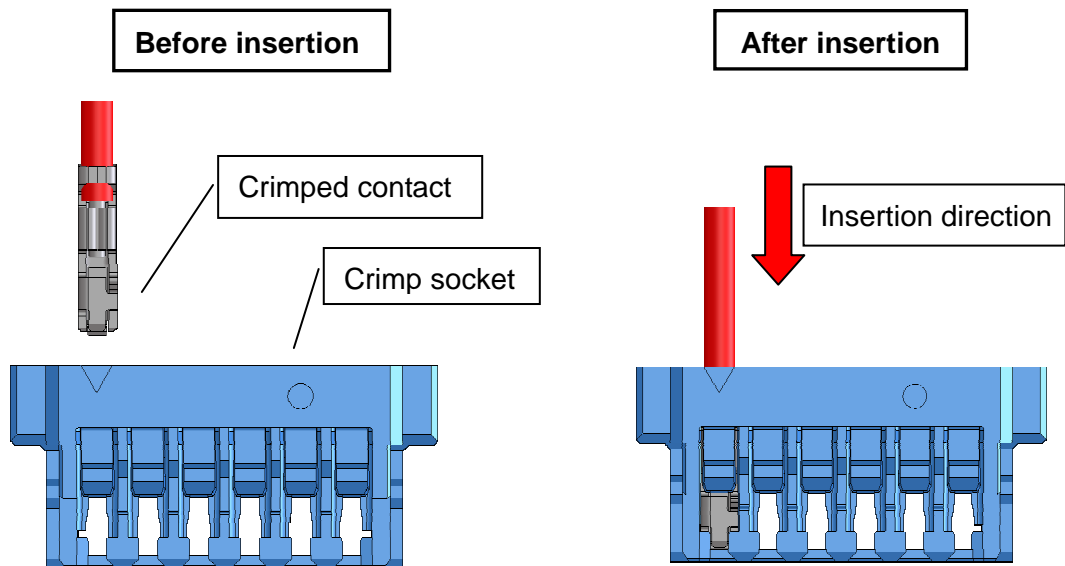
Hold the cable of crimped contact and insert to each contact cavity of the crimp case. (Insertion direction is as shown below.)



COUNT	DESCRIPTION OF REVISIONS	DESIGNED	CHECKED	DATE	
 2	DIS-H-009305	TH.YOSHIZAWA	HK.UMEHARA	14.12.15	
TITLE		 HIROSE ELECTRIC CO., LTD.			
DF52 Series Cable Assembly Procedure					
APPROVED	KI.AKIYAMA				14.06.27
CHECKED	HK.UMEHARA				14.06.27
		DESIGNED	TH.YOSHIZAWA	14.06.26	
		WRITTEN	TH.YOSHIZAWA	14.06.26	
TECHICAL SPECIFICATION		ETAD-H0791		 1 / 3	

-See below for the terminal numbers of crimping cases.

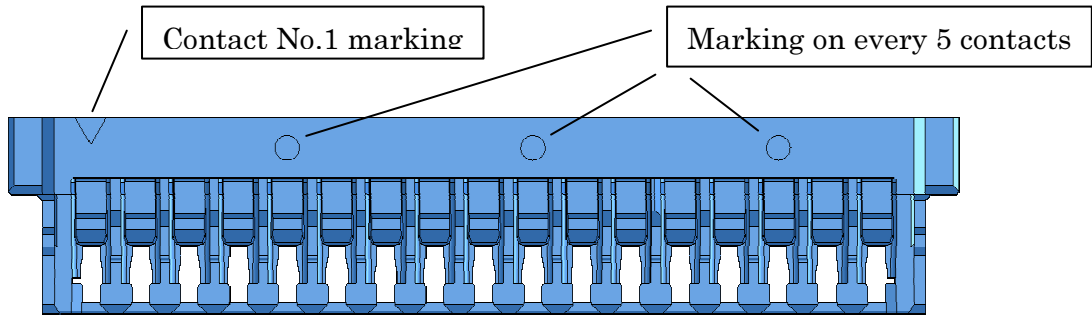

-Do not insert the crimped contact at an angle to the crimp case in order to maintain performance reliability.

Straight insertion (Correct)

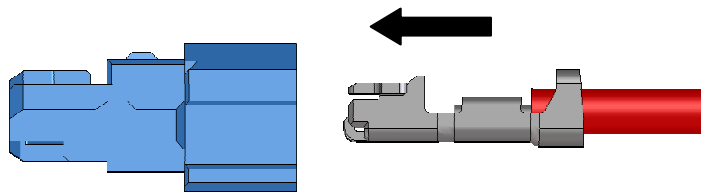

Angled insertion (Incorrect)

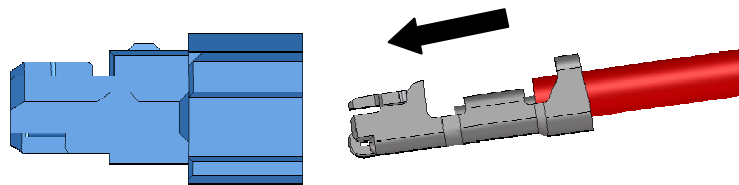

-Make sure that the contact lance is caught by the housing lance of the crimp case.

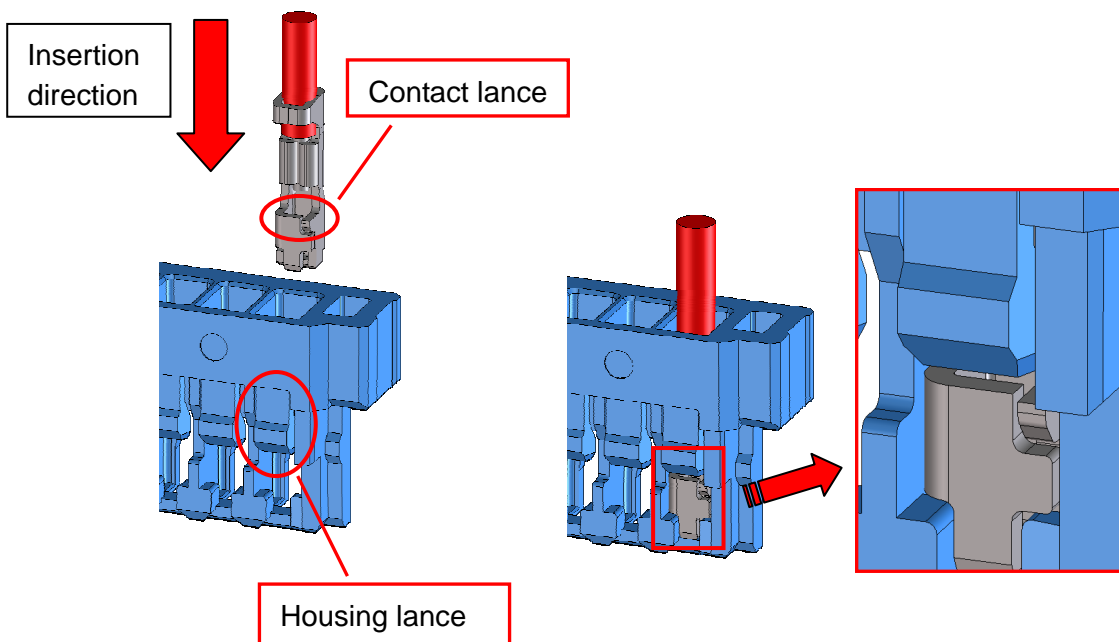

NOTE: Repairing the crimp contact

For removing the inserted crimp case, lift up the mold lance by using DF-C-PO(B) or a pointed needle and such, and pull out the cable simultaneously. This could lower the lance strength, therefore, do not reuse the crimp case and replace it to a new one.

