

High Current, Plastic Power Supply Connectors

EM Series



■ Features

1. 4-positions with high current capability (three-phase power supply and ground)

- Rated current of 50A per contact (50A/3contacts) with 8 AWG or corresponding wire. 70A per contact with 8 AWG wire and ambient temperature 25°C.
- Rated current of 30A per contact (30A × 3contacts) with 10 AWG or corresponding wire.
- (Please refer to the charts below concerning the relation between ambient temperature and working current value.)

2. Easy crimp termination

Crimp termination provides easy and stable termination process.

3. Standard tooling available

Terminals can be crimped with a standard tool in accordance with JIS C 9711.

4. Sequenced mating

Ground terminal makes contact first before power terminals touch.

5. Snap-in lock is easy to operate

Lock operation can be done by simply snapping the plug to the receptacle.

6. Attachment Styles

- DIN rail attachment type
- Snap-on attachment to 35mm width DIN rail.
- Panel attachment type
- Both front and back mounting applicable.

7. Ten keying combinations possible

Guide keys prevent incorrect insertions when multiple connectors are used together at the same time.

8. Meets approved safety standards

TÜV, UL certified.

Mated dimensions

(Mounted and mated dimensions on DIN rail)

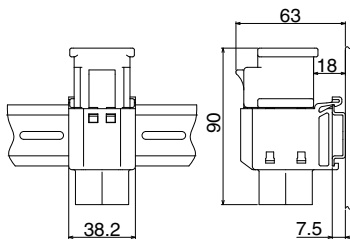

Derating curve

8 AWG

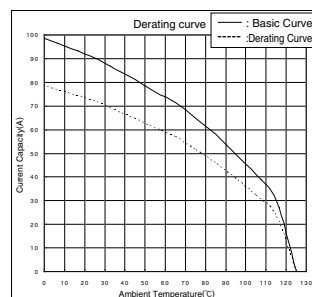

10 AWG

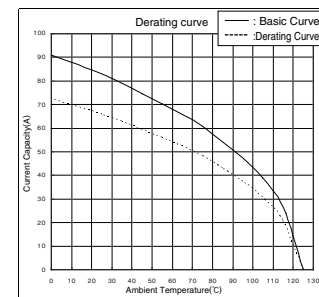

Note 1 : Derating curve is a curve that is obtained by multiplying the current value of the basic curve by derating factor of 0.8.

Note 2 : The value of rated current varies with the ambient temperature. It is recommended to use the product within the derating curve zone. When using a UL or TÜV approved product, please use the product within the specified range as well as the derating curve area.

Product Specifications

| | | | | |
|---------|-------------------------|---|-----------------------------|-------------------------|
| Rating | Current rating (Note 2) | 30A (10 AWG) 70A (8 AWG, Ambient Temperature 25°C) | Operating temperature range | -40°C to 125°C (Note 1) |
| | Voltage rating | AC 1000V, DC 1000V | Storage temperature range | -10°C to 60°C |
| UL, TÜV | Current rating (Note 2) | 30A (10 AWG) 50A (8 AWG) | Operating temperature range | -40°C to 125°C (Note 1) |
| | Voltage rating | AC 500V, DC 500V | Storage temperature range | -10°C to 60°C |

Note 1 : Including temperature rise due to current carrying.

Note 2 : The value of rated current varies with the ambient temperature. It is recommended to use the product within the derating curve zone. When using a UL or TÜV approved product, please use the product within the specified range as well as the derating curve area.

| Item | Specification | Condition |
|---|--|--|
| 1. Contact resistance | 1mΩ max. | Measured at DC 1A |
| 2. Insulation resistance | 5000MΩ min. | Measured at DC 500V |
| 3. Withstanding voltage | No flashover and insulation breakdown | AC 4260V for 1 minute |
| 4. Vibration resistance | No electrical discontinuity of 10μs or more | 10→50→10Hz/cycle, single amplitude of 0.75mm, five minutes/cycle, three directions, 10 cycles for each direction |
| 5. Shock resistance | No electrical discontinuity of 10μs or more | Acceleration of 490m/s ² , duration of 11ms, three directions, three times for each direction |
| 6. Durability | Contact resistance : 1mΩ max. | 100 cycles |
| 7. Temperature cycle | Insulation resistance : 5000MΩ min. | -55°C for 30 minutes→room temperature for 2 to 3 minutes→+125°C for 30 minutes→room temperature for 2 to 3 minutes, 5 cycles |
| 8. Humidity resistance (Normal condition) | Insulation resistance : 50MΩ min. (at high humidity condition) 500MΩ min. (at dry condition) | Exposed for 96 hours at the temperature of 40°C and the humidity of 90 to 95% |

Materials / Finish

| Item | Material | Finish | Remarks |
|------------|--------------|-----------------------------------|---------|
| Insulation | PBT resin | — | UL94V-0 |
| Contact | Copper alloy | Tin plated (Nickel under plating) | — |

Product Number Structure

Refer to the chart below when determining the product specifications from the product number. Please select from the product numbers listed in this catalog when placing orders.

●Connector

EM 35 M P - 4 S C ()**

① ② ③ ④ ⑤ ⑥ ⑦ ⑧

●Guide key

EM - GK ()**

① ④ ⑧

●Crimp terminal

EM - S C - 1 4 3 ()**

① ⑥ ⑦ ⑨ ⑩ ⑪ ⑧

| | |
|--|---|
| ① Series name : EM | ⑦ Type of termination : C = Crimp |
| ② Shell size : 35 | ⑧ This position will be used to indicate changes or variations to the product. When needed, there will be a 2 digit number within the parentheses. This number will correspond to specific changes and/or variations with the part. |
| ③ Specialty : M=Mold type(Plastic type) | |
| ④ Connector type : P= Plug R= Receptacle(DIN rail attachment type) GK= Guide key | ⑨ Terminal shape : 1= Loose piece terminal |
| ⑤ Number of contacts : 4 | ⑩ Shape modification : Design variation in the same size terminal is indicated with serial numbers starting from 1. |
| ⑥ Contact gender : S=Female contact, P=Male contact | |
| | ⑪ Plating : 3 = Tin plated |

■ Plug



| Part No. | HRS No. | Packaging |
|------------|------------|-----------|
| EM35MP-4SC | 138-0020-9 | 1 |
| EM35MP-4PC | 138-0021-1 | |

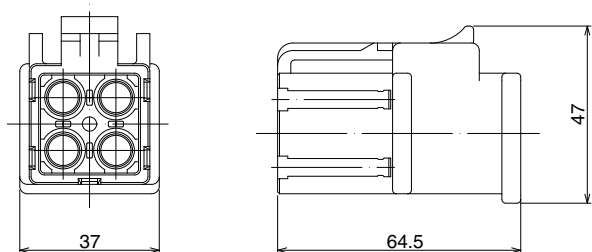

■ Receptacle (DIN rail attachment type)



| Part No. | HRS No. | Packaging |
|------------|------------|-----------|
| EM35MR-4PC | 138-0022-4 | 1 |
| EM35MR-4SC | 138-0023-7 | |

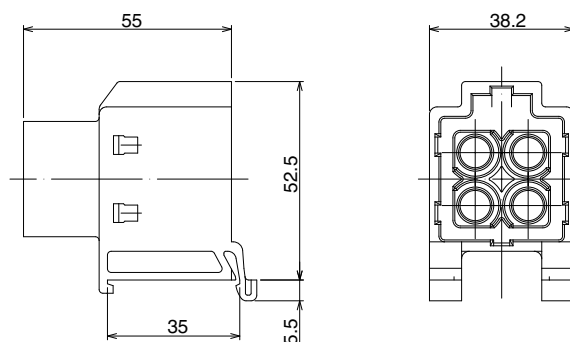

■ Cap

● For receptacle



| Part No. | HRS No. | Applicable connector | Packaging |
|----------|------------|----------------------|-----------|
| EM35MR-C | 138-0029-3 | EM35MR-4PC | 1 |
| | | EM35MR-4SC | |

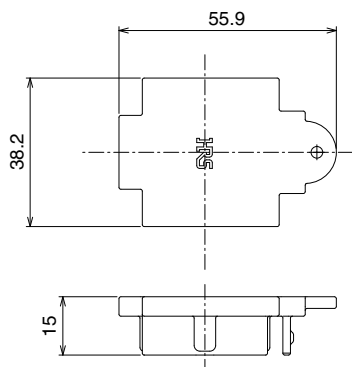

Jan. 1. 2021 Copyright 2021 HIROSE ELECTRIC CO., LTD. All Rights Reserved.

■ Crimp terminals

◆ Male terminals

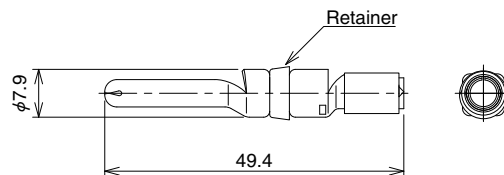

| Type | Part No. | HRS No. | Applicable wire | Remarks |
|-----------------------|---------------|---------------|---|-------------------|
| Loose piece terminals | EM-PC-113(01) | 138-0011-8 01 | (1) Cross sectional area of conductor : 5.26 to 5.57mm ² (corresponding to 10 AWG) (2) Outside diameter of conductor : ϕ 3.1 max. (3) Outside diameter of jacket : ϕ 8.7 max. (Wire needs to meet all the specifications listed in 1, 2 and 3.) | Retainer : black |
| | EM-PC-133 | 138-0019-0 | (1) Cross sectional area of conductor : 8mm ² (2) Outside diameter of conductor : ϕ 3.7 max. (3) Outside diameter of jacket : ϕ 8.7 max. (Wire needs to meet all the specifications listed in 1, 2 and 3.) | Retainer : white |
| | EM-PC-143(01) | 138-0025-2 01 | (1) Cross sectional area of conductor : 8.44 to 8.92mm ² (corresponding to 8 AWG) (2) Outside diameter of conductor : ϕ 4.4 max. (3) Outside diameter of jacket : ϕ 11.5 max. (Wire needs to meet all the specifications listed in 1, 2 and 3.) | Retainer : purple |

Note : 4 pcs/pack

◆ Female terminals

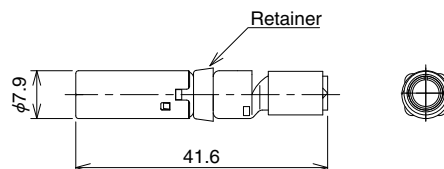

| Type | Part No. | HRS No. | Applicable wire | Remarks |
|-----------------------|---------------|---------------|---|-------------------|
| Loose piece terminals | EM-SC-113(01) | 138-0010-5 01 | (1) Cross sectional area of conductor : 5.26 to 5.57mm ² (corresponding to 10 AWG) (2) Outside diameter of conductor : ϕ 3.1 max. (3) Outside diameter of jacket : ϕ 8.7 max. (Wire needs to meet all the specifications listed in 1, 2 and 3.) | Retainer : black |
| | EM-SC-133 | 138-0018-7 | (1) Cross sectional area of conductor : 8mm ² (2) Outside diameter of conductor : ϕ 3.7 max. (3) Outside diameter of jacket : ϕ 8.7 max. (Wire needs to meet all the specifications listed in 1, 2 and 3.) | Retainer : white |
| | EM-SC-143(01) | 138-0024-0 01 | (1) Cross sectional area of conductor : 8.44 to 8.92mm ² (corresponding to 8 AWG) (2) Outside diameter of conductor : ϕ 4.4 max. (3) Outside diameter of jacket : ϕ 11.5 max. (Wire needs to meet all the specifications listed in 1, 2 and 3.) | Retainer : purple |

Note : 4 pcs/pack

◆ Coding key

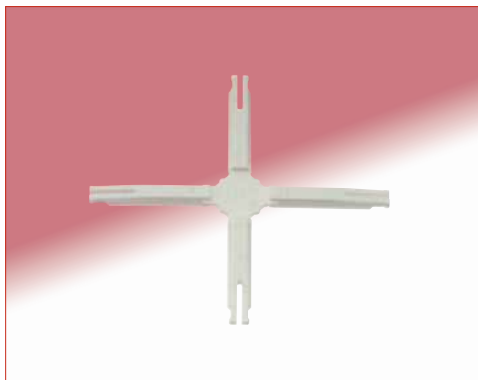

| Part No. | HRS No. |
|----------|------------|
| EM-GK | 138-0026-5 |

Note : 25 pcs/pack
Each sprue holds 4 coding keys and yields a total of 100 coding keys.

Coding keys are used to create keying combinations to prevent incorrect insertion. This is especially useful when multiple parts are being used together. Coding keys need to be installed on both the plug and receptacle when creating specific combinations.

Please contact a Hirose representative for details and proper use of coding keys.

◆ Coding key combination table

(Using two coding keys on the plug and three on the receptacle can make up to ten different combinations.)

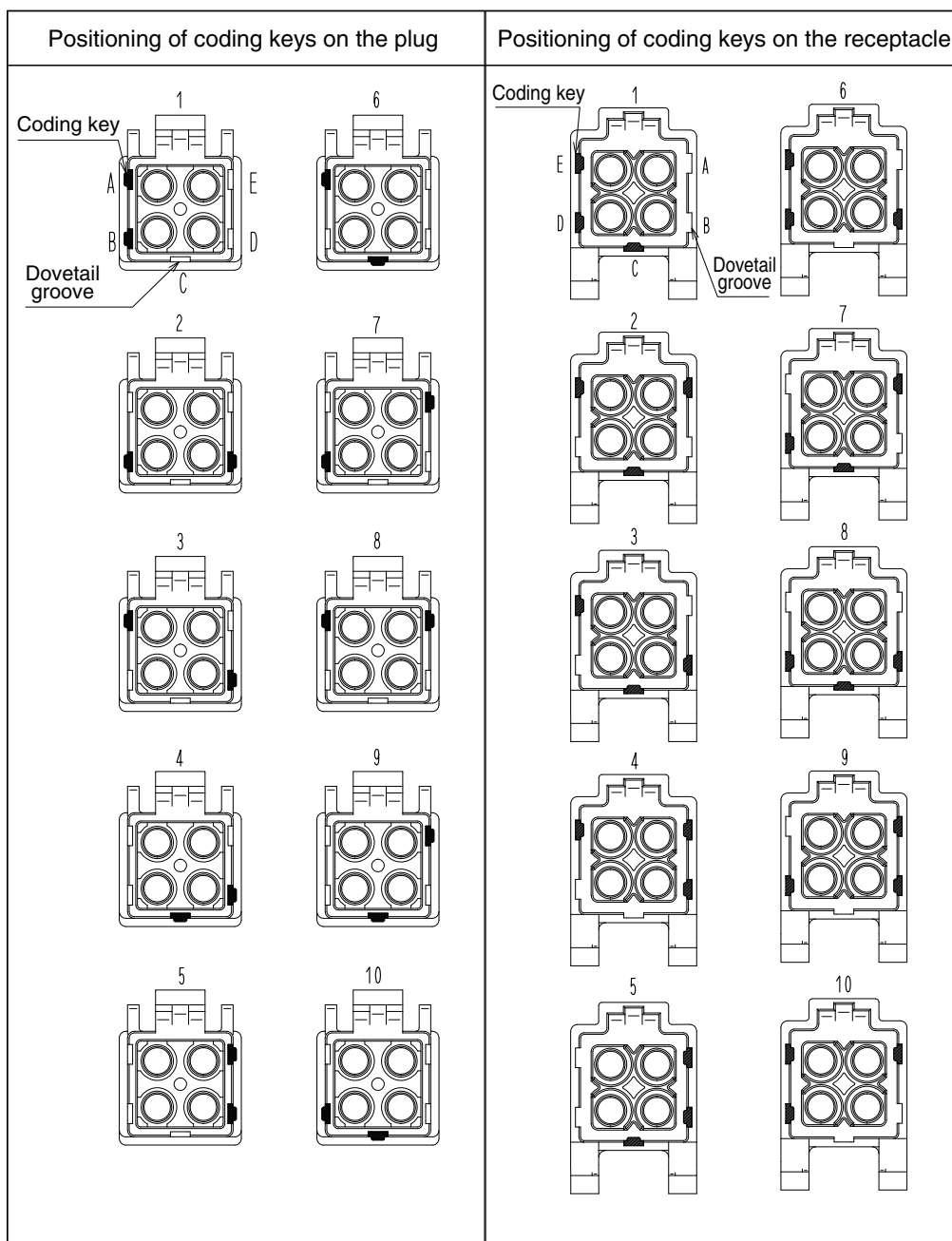

◆ Tools

| Type | Part No. | HRS No. | Applicable terminal |
|-------------------------|----------|------------|---|
| Manual crimping tool | Note 1 | — | EM-PC-113 (01) , EM-SC-113 (01) EM-PC-133 , EM-SC-133 EM-PC-143 (01) , EM-SC-143 (01) |
| Contact extraction tool | EM-8-TP | 150-0249-3 | EM-PC-113 (01) , EM-SC-113 (01) EM-PC-133 , EM-SC-133 EM-PC-143 (01) , EM-SC-143 (01) |

Note 1 : About manual crimping tools :

An applicable tool is a commercially available tool conforming to the JIS C 9711 standard "Termination tools for wire connector of interior wiring". Only use the recommended tools noted below.

Recommended crimping tools

| Tool manufacturer | Part No. |
|---------------------------------------|----------|
| HOZAN TOOL INDUSTRIAL CO., LTD. | P-75 |
| LOBTEX Co., Ltd. | AK15A |
| NICHIFU TERMINAL INDUSTRIES Co., Ltd. | NH1 |

● Manual crimping tool (Example)

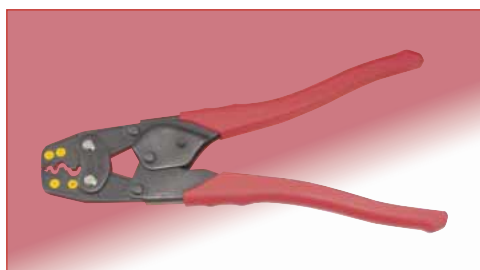

● Contact extraction tool

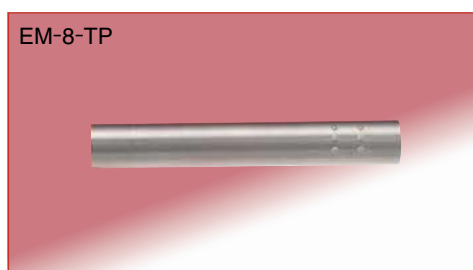

◆ Panel cut out dimensions

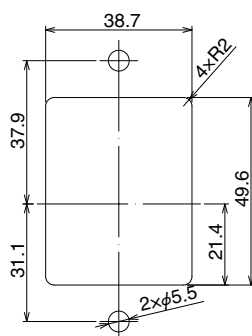

◆ Precautions when using the EM series connectors

1. Switch off the power before mating or un-mating the connectors.
2. Do not touch the terminal portion when the connector is energized. Doing so is potentially dangerous and can lead to injury.
3. Please contact a Hirose representative for harness work procedures and instruction manuals.



HIROSE ELECTRIC CO.,LTD.

2-6-3,Nakagawa Chuoh,Tsuzuki-Ku,Yokohama-Shi 224-8540,JAPAN

TEL: +81-45-620-3526 Fax: +81-45-591-3726

<http://www.hirose.com>

<http://www.hirose-connectors.com>