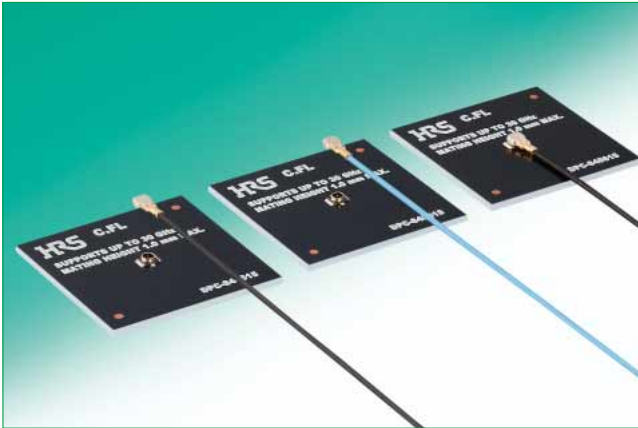
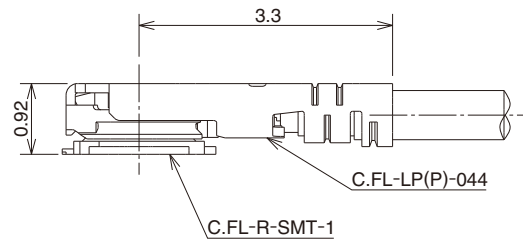

**NEW**

# 0.92mm mated height Low Height and Light Weight Miniature Coaxial Connectors Supporting up to 30GHz

## C.FL Series

### 50Ω Supporting up to 30GHz

**Mated Condition****Fig.1**

## ■ Features

### 1. Supports up to 30GHz

High frequency performance from DC to 30GHz. Suitable for the 28GHz band expected to be used in 5G communications.

### 2. Mated Height of 0.92mm (1.0mm Max.)

Receptacle mounting area is only 3.4mm<sup>2</sup>. Using the right-angle plug enables a mated height of 0.92mm, achieving the world's lowest class profile of coaxial connectors. (Fig.1)

### 3. Ultra lightweight

The world's smallest and lightest class of coaxial connectors.

Receptacle : 3.3mg

Right angle plug : 14.1mg

### 4. Automatic Board Placement

The embossed packaging allows for the receptacles to be automatically placed.

### 5. 50Ω Ultra-fine coaxial (fluorinated resin insulated) cables

Ultra-fine coaxial cables with a finished outer diameter of  $\phi$ 0.64mm (single shield) allow for connection in small, confined spaces with smooth and easy operation.

### 6. Tactile Lock

Clear tactile lock on small connector enables reliable mating.

### 7. Simple Connector Mating and Unmating

Dedicated Insertion and Extraction tools to enable proper mating/unmating.

## Product Specifications

Ratings	Nominal characteristic impedance 50Ω	Operating Temperature	-40 to +90°C (90%RH Max.)
	Frequency Range : DC to 30GHz	Storage Humidity Range	-20 to +70°C (90%RH Max.)

Item	Specifications	Conditions
1. Contact Resistance	Center : 60mΩ Max. Exterior : 20mΩ Max.	Measured at a maximum of 10mA
2. Insulation Resistance	500MΩ min	Measured at 100V DC
3. Withstanding Voltage	There shall be no flashover or dielectric breakdown	Apply 200V for 1 minute
4. V.S.W.R.*	1.4 Max.	DC to 15GHz
	1.5 Max.	15 to 20GHz
	1.6 Max.	20 to 30GHz
5. Durability	Contact Resistance Center : 65mΩ Max. Exterior : 25mΩ Max.	20 mating cycles

\*V.S.W.R. Measuring System

The above V.S.W.R. specification values are measured using the measurement system below.

### <Plug Harness Measurement System>

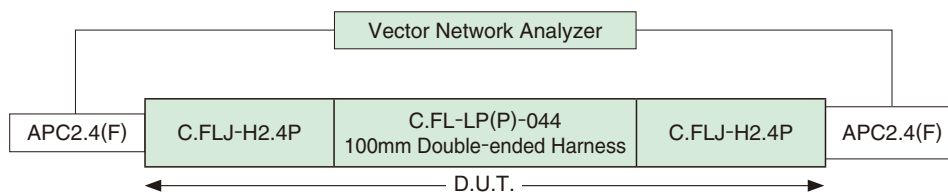

### <Receptacle Measurement System>

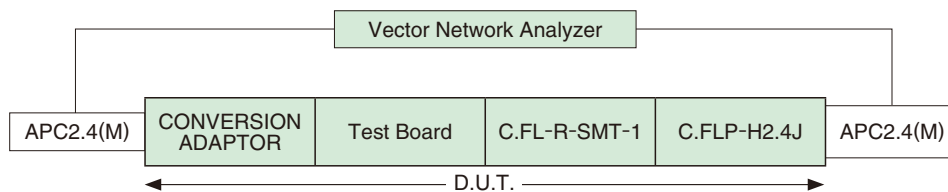

Note 1 : The cable connector is measured with a 2.4mm conversion adapter attached to double-ended harness with an applicable 10cm cable.

Note 2 : The board connector is measured while mounted to a 50Ω fluorine board with a 2.4mm conversion adapter attached.

## Material / Finish

	Component	Material	Finish/Remarks
Right angle Plug	Shell	Phosphor bronze	Partial gold plating
	Insulator	LCP resin	Black, UL94V-0
	Female Central Contact	Phosphor bronze	Gold plating
Receptacle	Shell	Phosphor bronze	Gold plating
	Insulator	LCP resin	Black, UL94V-0
	Male Central Contact	Brass	Gold plating
Adapter	Shell	Stainless steel	Nickel Plating
	Insulator	PTFE resin	—
	Male Center Contact	Phosphor bronze	Gold plating
	Female Central Contact	Beryllium copper	Gold plating

## ■ Plug

### ● C.FL-LP(P)-044 (Applicable Cable : outer diameter $\phi 0.64\text{mm}$ )

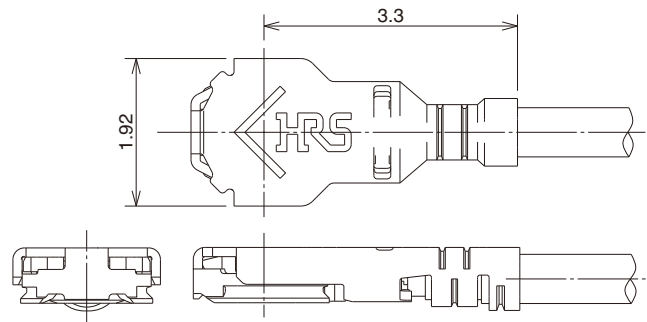

Please order plug with as cabled assembly

## ■ Cable Harness Specification

The dimension specifications of the C.FL Series harness are as follows.

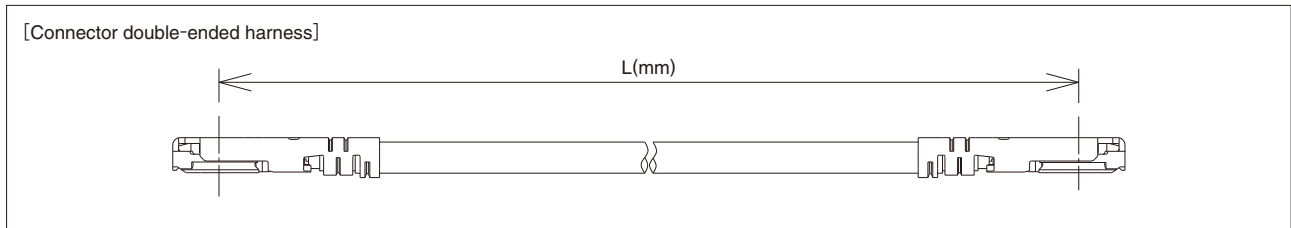

### ● Plug Product Number Structure

Refer to the charts below for determining specific part number characteristics.

Please select connectors listed in this catalog when placing orders and be sure to check the latest delivery specifications at the time of ordering the product.

**CFL - 2LPP - 044N [ ] TSH - A - L**

①                      ②                      ③                      ④                      ⑤                      ⑥

① Series Name C.FL	④ Cable Color 1 : White, 2 : Black, 4 : Blue
② Harness Type 2LPP : Double-ended L-shaped plug harness	⑤ Cable Outer Conductor Specifications TSH : Tin plated coiled shield
③ Cable Type 044N : $\phi 0.64$ cable	⑥ Total Length (mm) Length L (Based on mating center, Unit : mm)

### ● Cable Harness Total Length Standard Tolerance

Total Length L	Standard Tolerance (mm)
$41 \leq L \leq 170$	$\pm 0.3$

## ◆ High Frequency Characteristic Data (Typical Value)

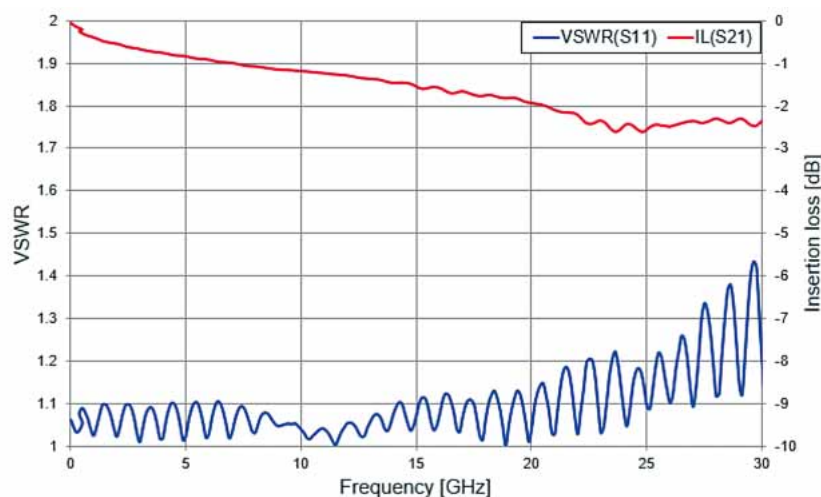

## ■ Receptacle



## ◆ Recommended PCB Mounting Pattern

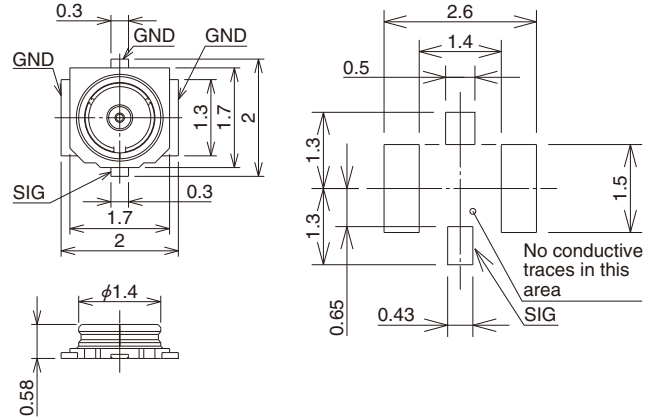

Part No.	HRS No.	Packaging	RoHS2
C.FL-R-SMT-1(90)	331-2200-0 90	20,000 pieces per reel	○

## ● Receptacle Product Number Structure

Refer to the charts below to determine specific part number characteristics.

Please select connectors listed in this catalog when placing orders and be sure to check specifications at the time of ordering.

**C.FL - R - SMT-1**

①      ②      ③

① Series Name	C.FL
② Connector Type R	: Receptacle
③ Mounting Method SMT-1	: Surface Mounting

## ◆ High Frequency Characteristic Data (Typical Value)

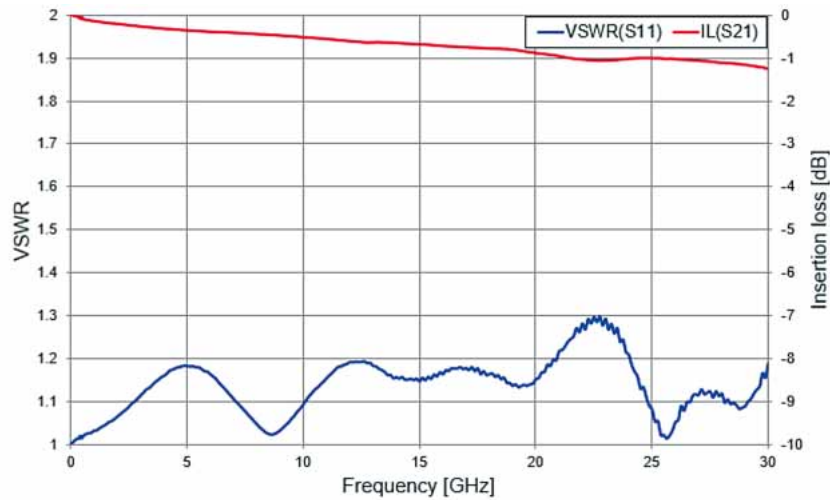

## ● Embossed Tape Specifications (JIS C 0806/IEC60286 Standard)

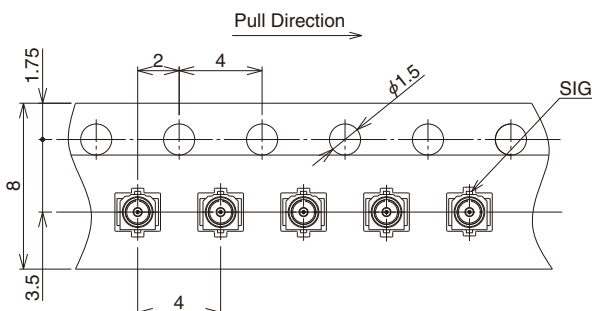

## ● Reel Specifications

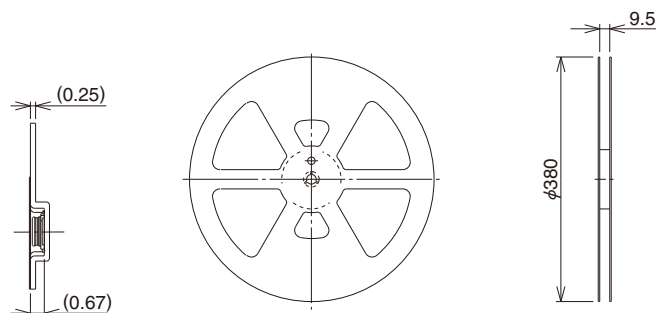

## ■ Conversion Adapter

### ● 2.4mm Conversion Adapter (Mated Portion : C.FL side : Jack-2.4mm side : Plug)

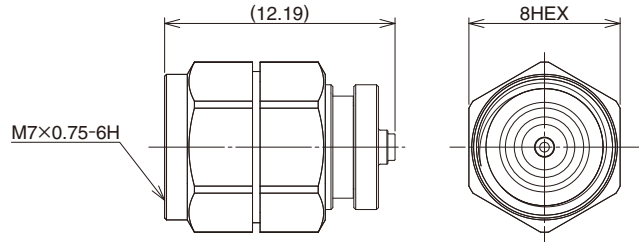

Part No.	HRS No.	RoHS2
C.FLJ-H2.4P	311-0017-0	○

Note : The mated portion of the C.FL side has a lower lock retention force than regular products so the adapter cannot be used for purposes other than performance measurements.

### ● 2.4mm Conversion Adapter (Mated Portion : C.FL side : Plug-2.4mm side : Jack)

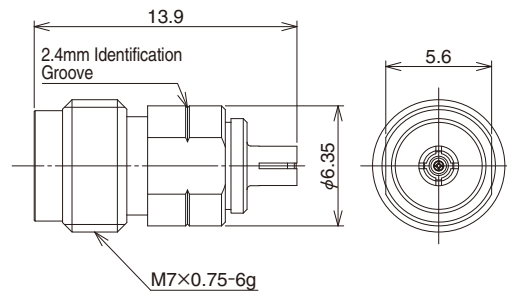

Part No.	HRS No.	RoHS2
C.FLP-H2.4J	311-0021-0	○

Note : The mated portion of the C.FL side has a lower lock retention force than regular products so the adapter cannot be used for purposes other than performance measurements.

### ● 2.92 Conversion Adapter (Mated Portion : C.FL side : Jack-2.92mm side : Plug)

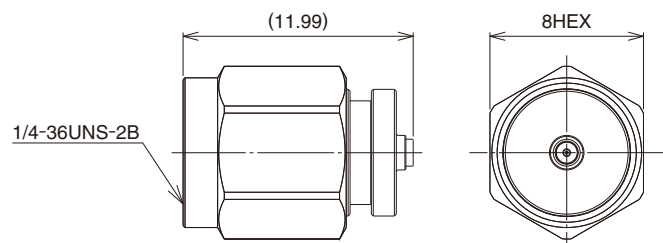

Part No.	HRS No.	RoHS2
C.FLJ-HKP	311-0023-0	○

Note : The mated portion of the C.FL side has a lower lock retention force than regular products so the adapter cannot be used for purposes other than performance measurements.

● 2.92 Conversion Adapter (Mated Portion : C.FL side : Plug-2.92mm side : Jack)

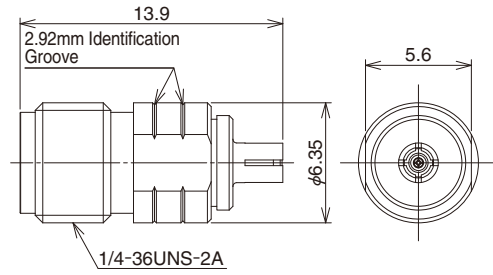

Part No.	HRS No.	RoHS2
C.FLP-HKJ	311-0024-0	○

Note : The mated portion of the C.FL side has a lower lock retention force than regular products so the adapter cannot be used for purposes other than performance measurements.

■ Insertion and Extraction Tool

Tool for mating and unmating the plug.

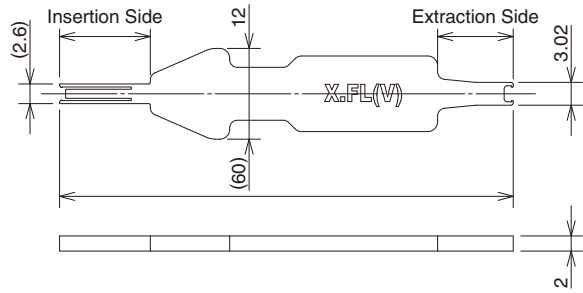

Part No.	HRS No.	RoHS2
X.FL(V)-LP-IN.OUT	331-0076-0	○

Note : The insertion and extraction tool may be deformed or damages if dropped, etc. so please handle with care.

## ◆ Usage Precautions

### 1. Plug

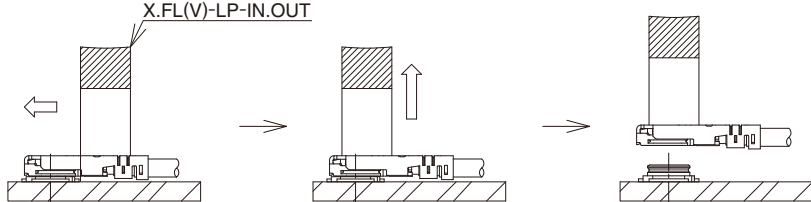
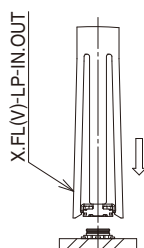
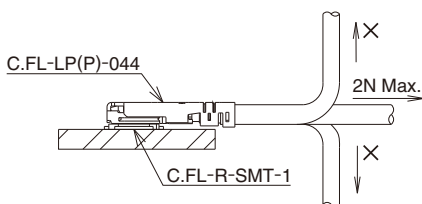
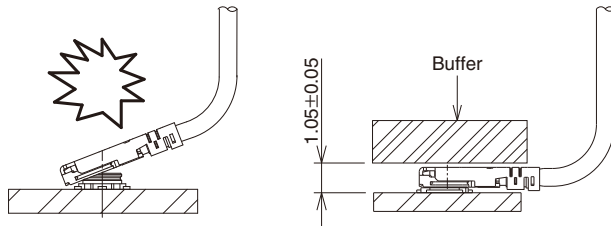
<p>(1) Mating / un-mating</p>	<p>① To un-mate, use the extraction tool X.FL-LP-IN.OUT as shown in the following figure. [How to un-mate a plug]</p>  <p>Do not un-mate a connector by pulling the cable as it may cause damage to the connector.</p> <p>② To mate a connector, use the mating side of the plug mating and unmating tool X.FL-LPIN. OUT. Align the mating axes between both connectors and check that the shell is properly aligned. The connector should be inserted perpendicularly as much as possible. (See the following figure)</p> 
<p>(2) Pull forces on the cable after connectors are mated</p>	<p>Once the connector is mated, do not apply a load to the cable in excess of the values indicated in the figure below.</p>  <p>Be careful when lifting the cable as it may add a load or cause unmating. It is recommended to place buffer on the plug when wiring in a direction that causes the cable to lift. (See figure below)</p> 
<p>(3) Precautions</p>	<p>Do not mate or unmate a connector with an excessive force as it may damage the connector.</p>

## 2. Receptacle

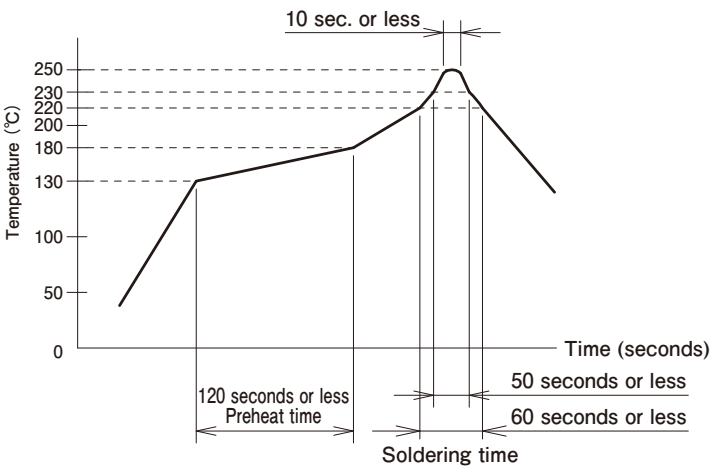
<p>(1) Recommended reflow temperature profile [reference]</p>	<div style="text-align: center;"> <p><b>Soldering profile for lead free solder (reference)</b></p>  </div> <ol style="list-style-type: none"> <li>1. The temperatures indicated are the surface temperatures on the printed circuit board at the points of contact with the terminals.</li> <li>2. Reflow soldering should be performed at peak temperature of 250°C or less at the surface of the printed circuit board.</li> <li>3. The temperature profile varies depending on conditions such as the size of the printed circuit board, the solder paste type, and solder thickness.</li> </ol>
<p>(2) Recommended metal mask thickness</p>	<p>0.1mm</p>
<p>(3) Reflow cycles</p>	<p>2 times</p>

## 3. Operating Environment and Storage Conditions

<p>(1) Operating environment</p>	<p>This product was designed under the assumption that it would be used in a normal operating environment. Use of this connector under adverse environmental conditions such as those described below is not advised and may lead to discoloration or other kinds of degradation.</p> <ul style="list-style-type: none"> <li>•Regions having exposure to excessive amounts of fine particles and dust</li> <li>•Areas with high densities of sulfur dioxide, hydrogen sulfide, nitrogen dioxide or other corrosive gases. (e.g., exhaust gas from automobiles or factories)</li> <li>•Environments having a large difference in temperature, such as near a heater.</li> </ul>
<p>(2) Storage conditions</p>	<p>Store the product in Hirose Electric's packaging or similar packaging conditions.                  Temperature : -10 to +40°C, humidity : 85% or less (recommended storage conditions)                  Use the product within six months from delivery.                  Products for which the storage period has expired must be tested for solderability before the use.</p>

**HIROSE ELECTRIC CO.,LTD.**

2-6-3,Nakagawa Chuoh,Tsuzuki-Ku,Yokohama-Shi 224-8540,JAPAN  
<https://www.hirose.com/>