

NEW

75 Ω Small Coaxial Connectors (SMT Low Profile)

H.FL75 Series

75 Ω, up to 3 GHz

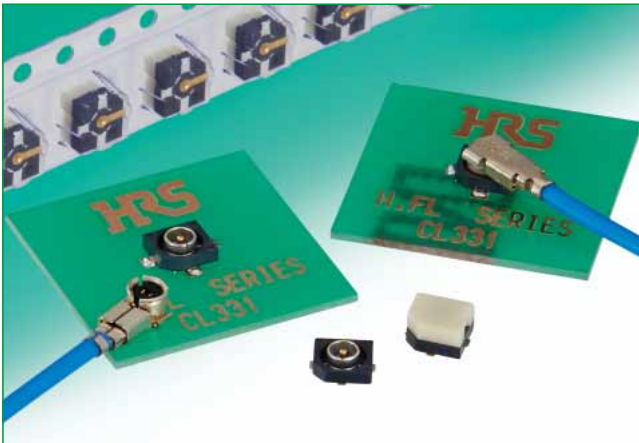

Figure 1 Connector mating external view

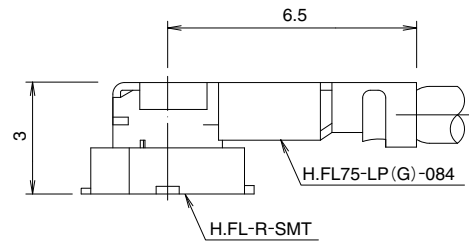

Figure ①

■ Features

1. Miniature, 75Ω coaxial RF connector

A mated receptacle and right-angled plug delivers a low mated height of only 3 mm from the printed circuit board (see Fig. ①).

2. High impedance matching

High impedance matching is used to produce its high frequency response from DC to 3 GHz, which is suitable for 3G-SDI broadcasting equipment.

3. Terminated with 75 Ω, ultra-fine coaxial cable

The use of $\phi 1.5$ mm, ultra-fine coaxial (fluorinated resin insulated) cables make this connector perfect for applications that require wiring in tight spaces.

4. Suitable for use with 3G-SDI equipment

Used together with BNC (75) Series connectors, it's possible to maintain 75 Ω system lines from the interface connections to the internal wiring systems.

5. Supports automatic mounting

The receptacles are packaged on reels which supports automatic pick-and-place mounting. Capped receptacles are available and are suitable for use with virtually all types of mounting machines.

6. Easy mating with protected design

The design structure emits a clear tactile click when mating is completed. Even though small in size, the receptacle's design adds extra protection to the mating area.

7. Simple un-mating process

An extraction tool is available which simplifies the un-mating process.

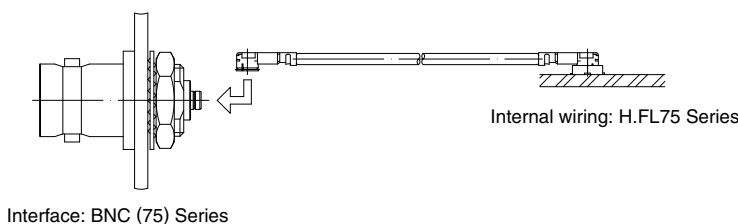

Product Specifications

Ratings	Nominal characteristic impedance: 75 Ω	Operating temperature range: -40°C to +90°C (RH 90% max.)
	Voltage: AC 60 V rms	
	Frequency range: DC to 3 GHz	Storage temperature range: -30°C to +70°C (RH 90% max.)

Items	Specifications	Conditions
1. Contact resistance	Center: Maximum of 20 mΩ Outer: Maximum of 10 mΩ	Measured with 10 mA max.
2. Insulation resistance	Minimum of 500 MΩ	Measured with 250 VDC
3. Withstanding voltage	No flashover or insulation breakdown	AC 300 V / 1 minute.
4. V.S.W.R. (*)	Maximum of 1.25	DC to 1.5 GHz
	Maximum of 1.5	1.5 to 3 GHz
5. Holding power of female contact	Minimum of 0.15 N	Measured with φ0.475 pin gauge.
6. Total mating/unmating force	Maximum of 30 N	Measured with applicable connector.
7. Durability (mating/unmating with corresponding plug)	Contact resistance Center: Maximum of 25 mΩ Outer: Maximum of 15 mΩ	50 mating cycles.
8. Vibration resistance	No electrical discontinuity for 1 μs or more. No damaged, cracks or loose parts.	Frequency of 10 to 100 Hz, single amplitude of 1.5 mm, acceleration of 59 m/s ² , for 5 cycles in each of the 3 axes direction.
9. Shock resistance	No electrical discontinuity for 1 μs or more. No damaged, cracked or loose parts.	Acceleration of 735 m/s ² , for a duration of 11 ms, sine half-wave waveform, 3 cycles in each of the 6 axes direction.
10. Humidity resistance (Steady state)	No damaged, cracked or loose parts Insulation resistance: 10 MΩ min. (high humidity) Insulation resistance: 500 MΩ min. (dry)	96 hours at temperature of 40°C and humidity of 95% .
11. Temperature cycle	No damaged, cracked or loose parts. Contact resistance Center: Maximum of 25 mΩ Outer: Maximum of 15 mΩ	Temperature: -40°C → +5 to +35°C → +90°C → +5 to +35°C Time: 30 → 5 max. → 30 → 5 max. (minutes) 5 Cycles
12. Salt spray	No excessive corrosion	5% salt water solution for 48 consecutive hours

*V.S.W.R. Measurement System

The above V.S.W.R. specification values were measured using the measurement system shown below.

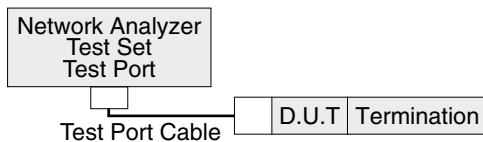

Note 1: Cable type connectors were measured with BNC (75) conversion adapters attached to both ends of the harness product of a suitable 10 cm cable.

Note 2: Board type connectors were mounted to a 75 Ω glass epoxy board and measurements were conducted with N (75) connectors attached.

Materials

Part	Material		Finish	Remarks
Shell	Phosphor bronze		Silver plated	—
Male center contact	Brass		Gold plated	—
Female center contact	Phosphor bronze		Gold plated	—
Insulator	Plug	PBT Resin	Black	UL94V-0
	Receptacle	LCP	Black	UL94V-0

Plug

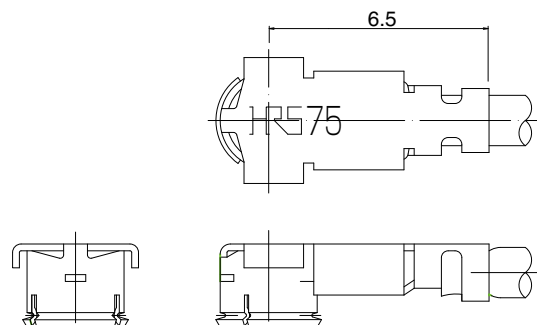

[Plugs are only sold as cabled assemblies]

How to Specify Plug Cable Assembly

The dimensions of a cable assembly of the H.FL75 series should be specified as follows:

[Single-Ended Cable Assembly]

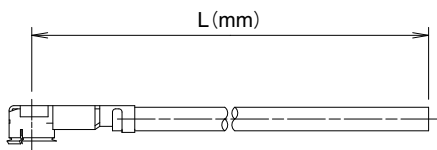

[Double-Ended Cable Assembly]

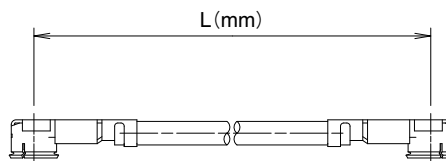

Product Number Structure of Cable Assemblies

Refer to this page when determining product specifications by model types. Please place orders with part numbers listed in this catalog. The characteristics and specifications of the product described in this catalog are reference values. Please make sure to check the latest delivery specifications at the time of product use.

Standard Tolerances for (L)

L (mm)	Standard Tolerance (mm)
$35 \leq L \leq 200$	± 4
$200 < L \leq 500$	± 8
$500 < L \leq 1000$	± 12
$1000 < L$	$\pm 1.5\%$ of L

Note: 35 mm is the shortest length (L) that can be made.

H.FL75 - [] LPG - [] - A - (L)

1 Series name	H.FL75
2 Assembly type	None: Single-ended, 2: Double-ended
3 Cable type	084N: for $\phi 1.5$ mm cable
4 Cable color	1: White, 2: Black, 4: Blue
5 Total length L (mm)	L length in mm

Receptacle

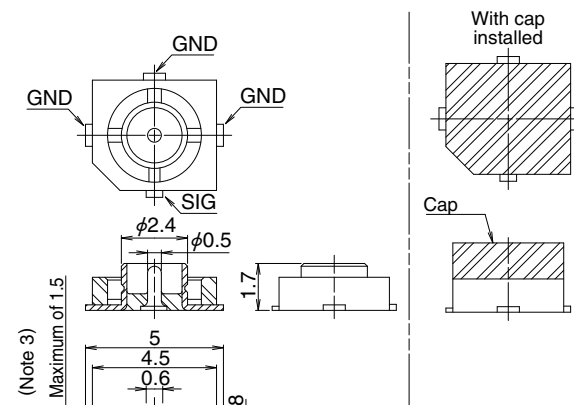
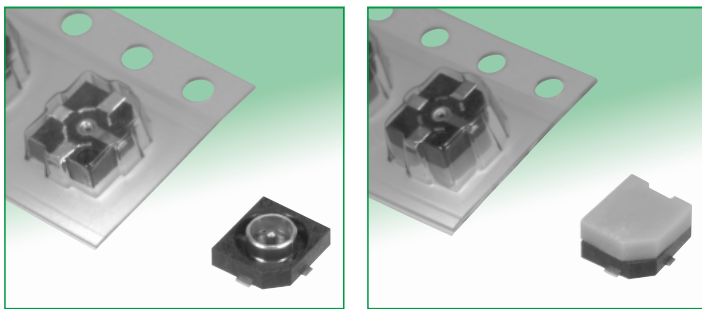

Note 1: Receptacles that are specified by (01) are sold in 100 piece packs. Please order in full pack quantities.

Note 2: Receptacles that are specified by (10) are sold in full reel quantities, each reel contains 2,500 pieces. Please order in full reel quantities.

Note 3: This area may be covered by insulating material.

Note 4: The H.FL-R-SMT (C) (10) comes equipped with a cap that allows it to be mounted by almost any pick and place machine. Remove cap after the reflow process.

Recommended PCB layout dimensions

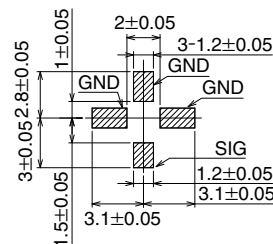

Part No.	HRS No.	Packaging	Remarks
H.FL-R-SMT(01)	CL331-0521-6-01	100 pieces per pack	-
H.FL-R-SMT(10)	CL331-0521-6-10	2,500 pieces per reel	-
H.FL-R-SMT(C)(10)	CL331-0522-9-10	2,500 pieces per reel	With caps

◆ Embossed Carrier Tape Dimensions (JIS-C-0806 compliant)

The diagram below shows the embossed carrier tape dimensions used to package the H.FL-R-SMT(10).

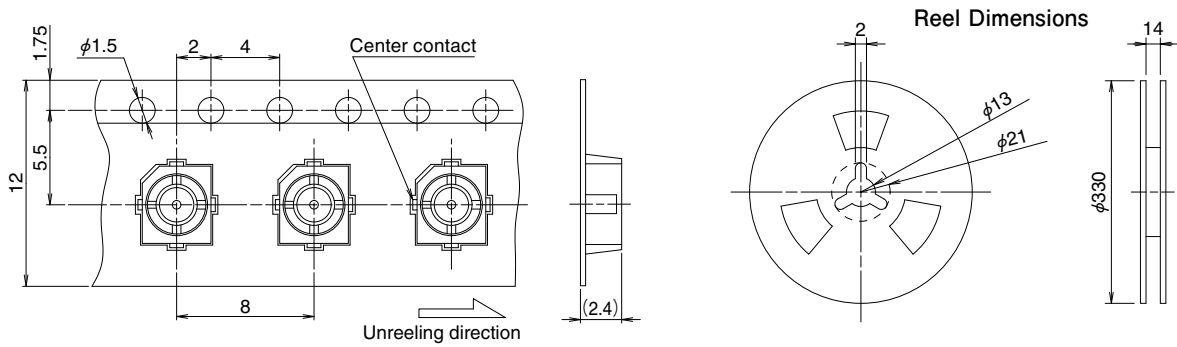

■ Conversion Adapter

● BNC (75) Conversion Adapter (Mating portion - H.FL75 side: jack - BNC (75) side: jack)

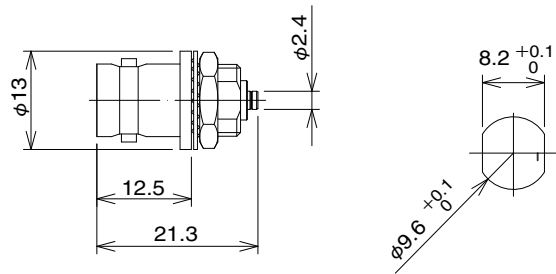

Part No.	HRS No.	RoHS
BNC(75)J-H.FLJ-BPA(40)	CL311-0302-8-40	○

◆ Plug Extraction Tool

This is the recommended tool for un-mating the plug when in the mated condition.

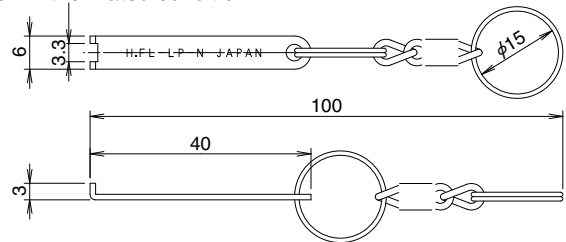

Part No.	HRS No.	RoHS
H.FL-LP-N	CL331-0551-7	○

◆ Usage Precautions

1. Plugs

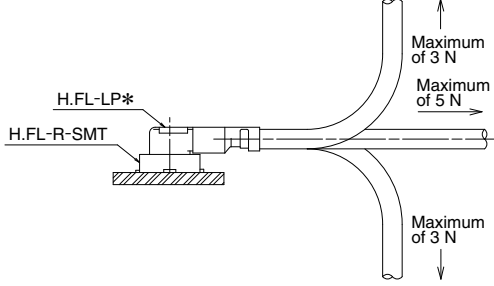
(1) Mating / un-mating	<p>① To disconnect the connector, insert the extraction tool (H.FL-LP-N) under the connector flange. Pull in a perpendicular direction, or in the direction of the connectors mating axis. Do not un-mate the plug by pulling on the cable, this can damage the connector and alter its performance.</p> <p>② To mate the connector, align the mating axes between the receptacle and cable assembly, and insert the cable assembly downward and perpendicular into the receptacle. Do not insert the cable assembly at a slanted angle.</p>
(2) Allowable load to a cable when mated.	<p>After the connector has been mated, prevent excessive force being placed onto the cable. Please reference the tolerances listed below.</p> 
(3) Precautions	<p>Do not use excessive prying forces to mate or un-mate these connectors, failure to follow this precaution can lead to the connector becoming damaged.</p>

2. Receptacles

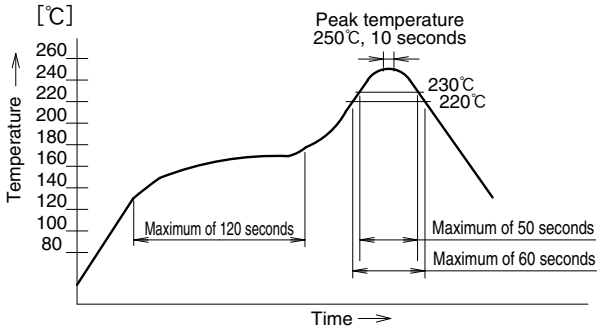
(1) Recommended reflow temperature profile [reference]	<p style="text-align: center;">Reflow temperature profile (reference)</p>  <p>① The temperatures indicated are the surface temperatures of the printed circuit board near the terminal contact points.</p> <p>② Reflow soldering should be performed at a peak temperature of 250°C or less at the surface of the printed circuit board.</p> <p>③ Temperature profiles may vary due to external mounting conditions; conditions such as solder paste types, manufacturer, PCB size and any other soldering materials may alter the performance of such materials.</p>
(2) Recommended manual soldering [reference]	<p>Soldering iron temperature: 350°C, soldering time: Maximum of 5 seconds.</p>
(3) Recommended metal mask thickness	<p>0.1 to 0.15 mm</p>
(4) Reflow cycles	<p>Maximum of 2 cycles</p>

3. Operating Environment and Storage Conditions

(1) Operating environment	<p>This product was designed on the assumption that it will be used in a normal environment. Please be advised that using these connectors in certain environments may lead to discoloration or other types of degradation.</p> <ul style="list-style-type: none"> • Exposed to a excessive amounts of fine particles and dust • Regions and places having a high density of sulfur dioxide, hydrogen sulfide, nitrogen dioxide or other corrosive gasses. (e.g., exhaust gas from automobiles or factories) • Environments that experience large changes in temperatures, such as locations near a heater.
(2) Storage conditions	<p>Store the product in Hirose Electric's packaging or similar packaging conditions. Temperature: -10 to +40°C, humidity: 85% or less (recommended storage conditions) We recommend that this product be consumed within six months from delivery. For products that have been stored and the storage period has expired, they need to be tested for solderability before use.</p>

◆ High Frequency Characteristics of related 75 Ω Hirose products

● BNC (75) Series

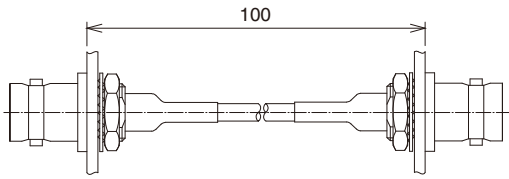

BNC(75)-BPJ-1.5CV-※

BNC(75)-BPJ-1.5CV-※

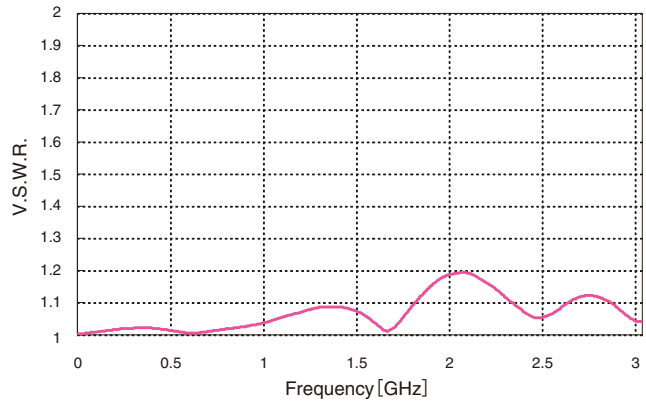

● PL71 Series

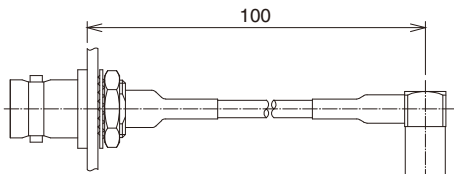

BNC(75)-BPJ-1.5CV-※

PL71-LP-1.5C(40)

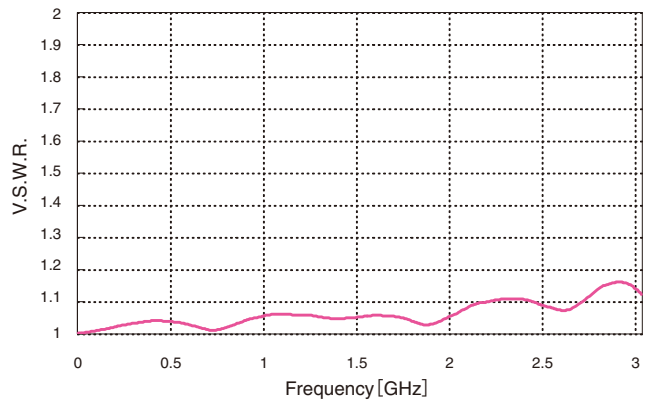

● PL75 Series

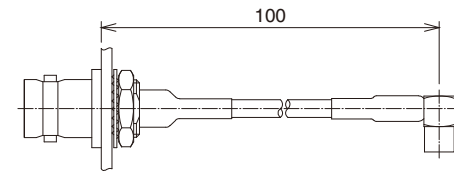

BNC(75)-BPJ-1.5CV-※

PL71-LP-1.5CV

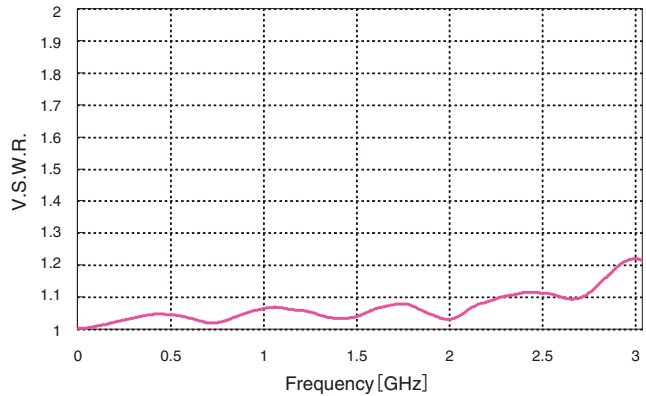

● H.FL75 Series

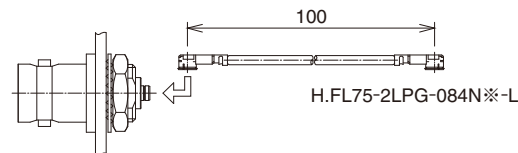

BNC(75)J-H.FLJ-BPA(40)

H.FL75-2LPG-084N※-L

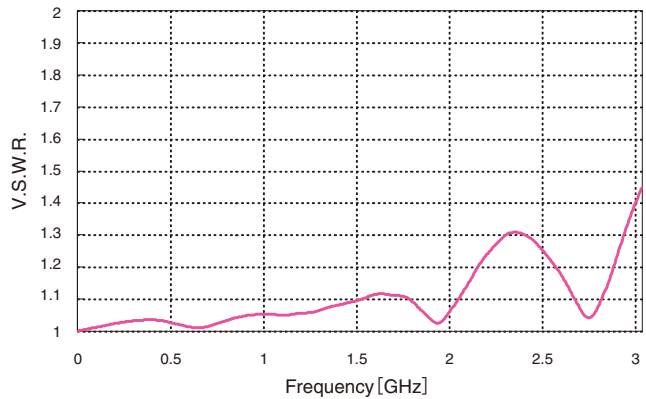

HIROSE ELECTRIC CO.,LTD.

6-3,Nakagawa Chuoh-2-Chome,Tsuzuki-Ku,Yokohama-Shi 224-8540,JAPAN

TEL: +81-45-620-3526 Fax: +81-45-591-3726

<http://www.hirose.com>

<http://www.hirose-connectors.com>