

H.FL75 Series

Compact 75 Ω Coaxial Connectors (Low Profile SMT)



75 Ω



Compact



RF

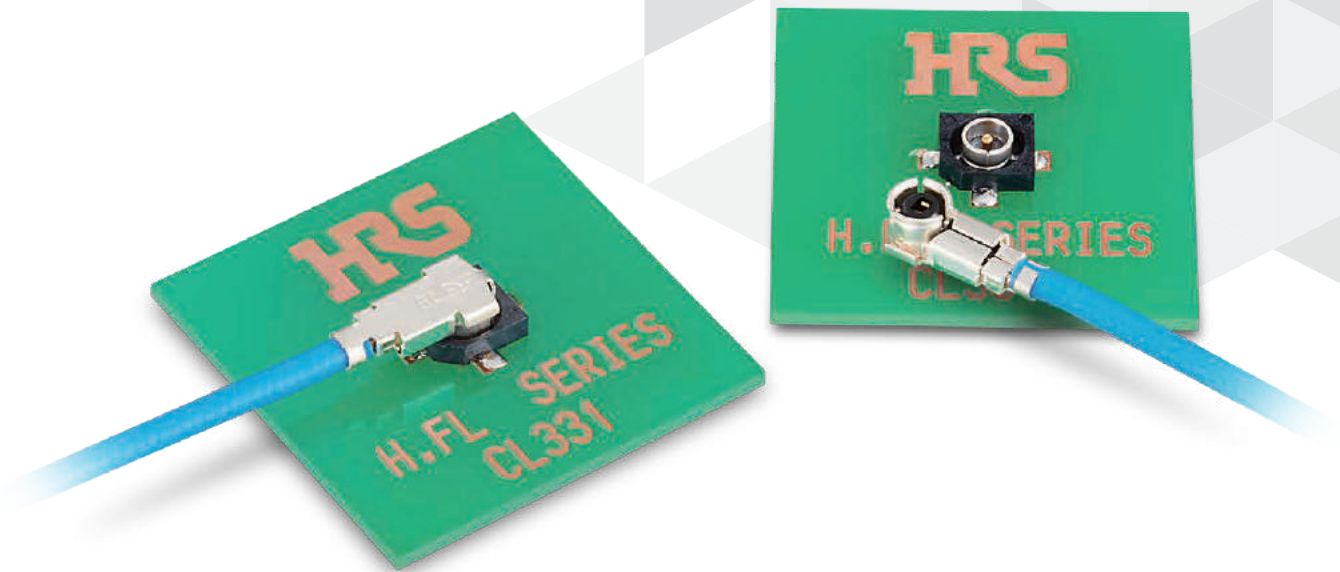

Features

1. Compact 75Ω Coaxial Connector

The receptacle and right-angled plug produce a mated height of only 3mm from the PCB.

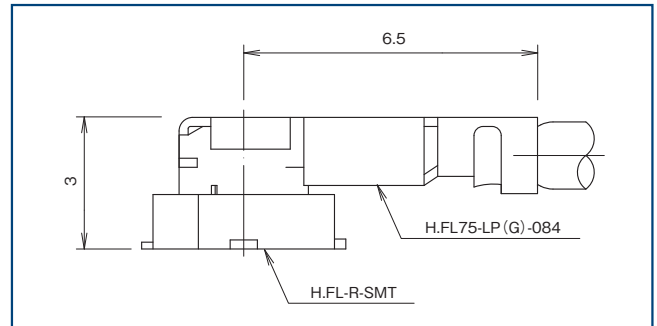

Mated Connector Dimensions

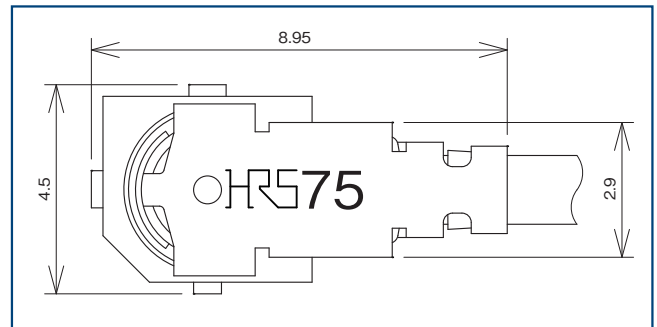

PCB Mounting Space During Mated

2. Ultra-fine Coaxial (Fluorinated Resin Insulated) Cables

The use of $\phi 1.5\text{mm}$, ultra-fine coaxial (fluorinated resin insulated) cables make this connector perfect for applications that require wiring in tight spaces.

3. RF Performance (up to 3GHz) Suitable for 3G-SDI Broadcasting Equipment

High frequency performance from 0 to 3GHz. In combination with BNC 75 Series, etc., connection is possible with 75 Ω system line from interface connection to internal wiring.

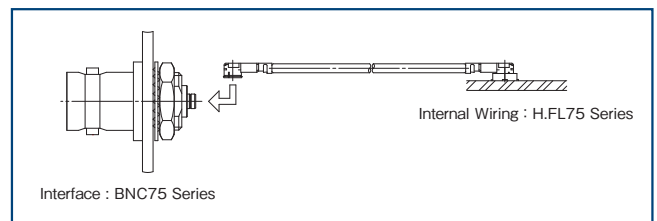

4. Supports Automatic Mounting

The receptacles are packaged on reels which supports automatic pick & place mounting. Capped receptacles are available and are suitable for use with virtually all types of mounting machines.

5. Lock Click, Mated Part Protective Shape

Even with the compact size, a clear tactile click is emitted when mating is completed. The receptacle surrounds the plug tip and protects the connection.

6. RoHS2 Compliant

Product Specifications

Nominal Characteristic Impedance	75 Ω	Operating Temperature	-40 to +90°C (90%RH Max.)
Rating Voltage	60V AC	Storage Temperature Range	-30 to +70°C (90%RH Max.)
Frequency Range	0 to 3GHz		

Items	Specifications	Conditions
Contact Resistance	Center : 20m Ω Max. Outer : 10m Ω Max.	Measured with 10mA Max.
Insulation Resistance	500M Ω Min.	Measured with 250V DC
Withstanding Voltage	No insulation breakdown	300V AC for 1 min.
V.S.W.R.*	1.25 Max.	0 to 1.5GHz
	1.5 Max.	1.5 to 3GHz
Retention Power of Female Contact	0.15N Min.	Measured with φ 0.475 pin gauge.
Total Mating/ Unmating Force	30N Max.	Measured with applicable connector.
Mating Durability	Contact Resistance Center : 25m Ω Max. Outer : 15m Ω Max.	50 times
Vibration Resistance	No electrical discontinuity for 1 μ s or more. No damaged, cracks or loose parts.	Frequency of 10 to 100 Hz, single amplitude of 1.5 mm, acceleration of 59m/s ² , for 5 cycles in each of the 3 axes direction.
Shock Resistance	No electrical discontinuity for 1 μ s or more. No damaged, cracks or loose parts.	Acceleration of 735m/s ² , for a duration of 11 ms, sine half-wave waveform, 3 cycles in each of the 6 axes direction.
Humidity Resistance (Steady State)	No damaged, cracked or loose parts Insulation resistance : 10M Ω Min. (High Humidity) Insulation resistance : 500M Ω Min. (Dry)	96 hours at temperature of 40°C and humidity of 95%.
Temperature Cycle	No damaged, cracked or loose parts. Contact Resistance Center : 25m Ω Max. Outer : 15m Ω Max.	Temperature : -40°C → +5 to +35°C → +90°C → +5 to +35°C Time : 30 min. → 5 min. Max. → 30 min. → 5 min. Max. 5 cycles
Salt Spray	No corrosion that impairs function.	5% salt water solution for 48 consecutive hours

* V.S.W.R. Measurement System

The above V.S.W.R. specification values were measured using the measurement system shown below.

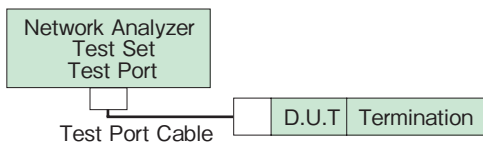

Note 1 : Cable type connectors were measured with the BNC75 conversion adapter attached to the cable assembly at both ends of a compatible 10cm cable.

Note 2 : Board connectors were measured while mounted on a 75 Ω glass epoxy board with BNC75 connectors attached.

Material / Finish

Part	Material		Finish	Remarks
Shell	Phosphor Bronze		Silver Plated	—
Male Contact	Brass		Gold Plated	—
Female Contact	Phosphor Bronze			—
Insulator	Plug	PBT	Black	UL94V-0
	Receptacle	LCP		

Product Number Structure

Refer to the chart below when determining the product specifications from the product number.
Please select from the product numbers listed in this catalog when placing orders.

● Receptacle

H.FL - R - SMT (C) (10)

① ② ③ ④ ⑤

① Series Name	H.FL	④ Receptacle Type	(C) : With Suction Cap None : Without Suction Cap
② Connector Type	R : Receptacle	⑤ Packing Type	(01) : Packing (100pcs per bag) (10) : Reel Packing (2,500pcs per reel)
③ Cable Type	SMT : Printed Circuit Board Surface Mount Type		

Note : Please order the plug in cable assembly specifications.

● How to Designate Plug Cable Assembly Dimensions

The dimensions of the H.FL75 Series cable assembly should be specified as follows :

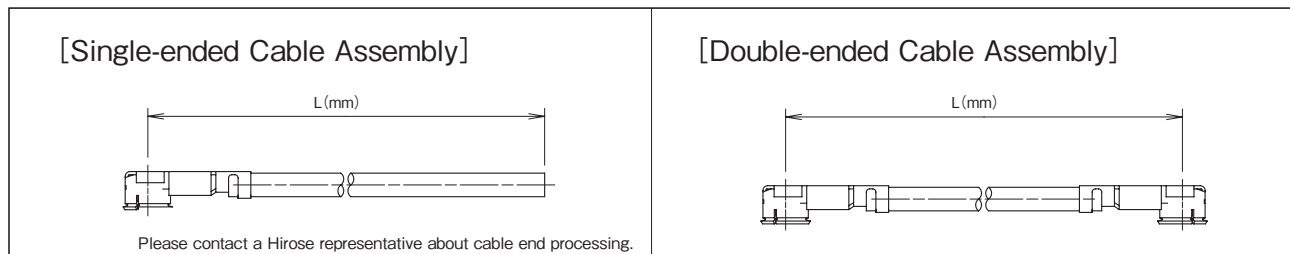

Note : Designate the dimensions from the center of the connector for both single-ended and double-ended cable assemblies. (Please write length L in mm.)

● Cable Assembly Product Number Structure

H.FL75 - 2LPG - 084N 4 - A - (L)

① ② ③ ④ ⑤

① Series Name	H.FL75	③ Cable Type	084N : for ϕ 1.5mm cable
② Assembly Type	LPG : Single-ended 2LPG : Double-ended	④ Cable Color	4 : Blue
		⑤ Total Length	L length in mm

● Standard Tolerances for (L)

Total Length L (mm)	Standard Tolerance (mm)
$35 \leq L \leq 200$	± 4
$200 < L \leq 500$	± 8
$500 < L \leq 1000$	± 12
$1000 < L$	$\pm 1.5\%$

Note : The shortest length is L = 35mm

Conversion Adapter

BNC75 Conversion Adapter

(Mated Portion - H.FL75 Side : Jack, BNC75 Side : Jack)

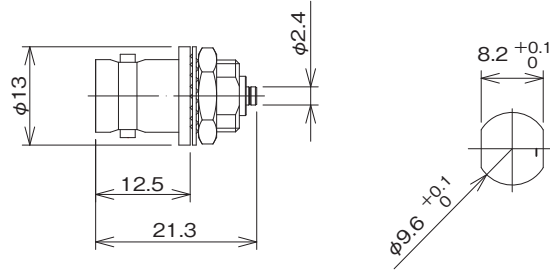

Part No.	HRS No.	Purchase Unit
BNC(75)J-H.FLJ-BPA(40)	CL0311-0302-8-40	20pcs per bag

Embossed Carrier Tape Dimensions (JIS-C-0806, IEC60286 Compliant)

Dimensions of the embossed carrier tape for H.FL-R-SMT(10) are shown below.

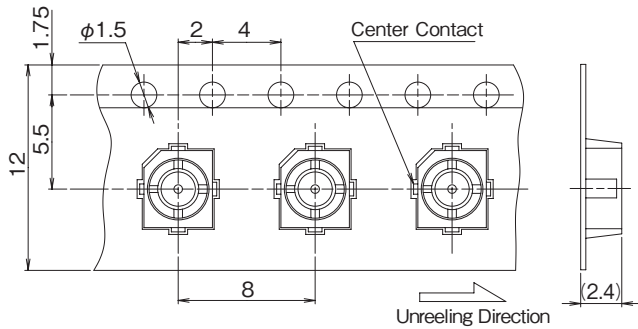

Reel Dimensions

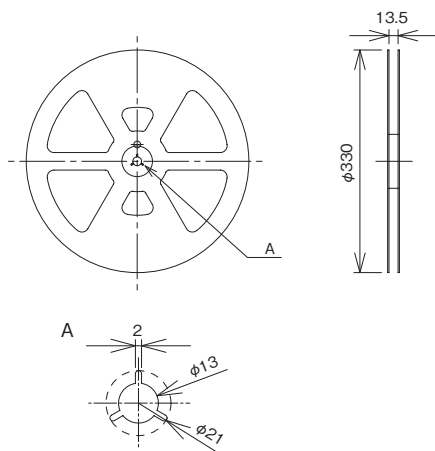

High Frequency Performance of 75Ω Products

● BNC75 Series

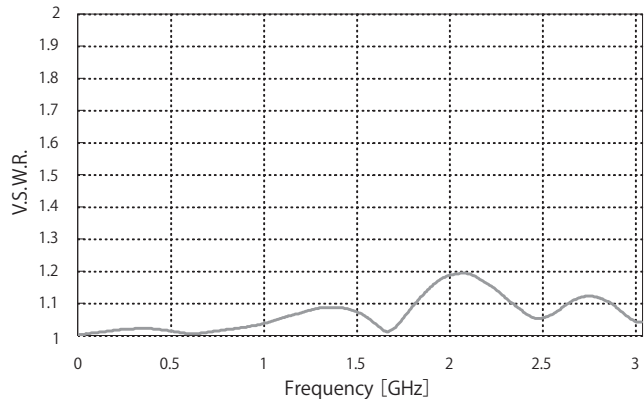
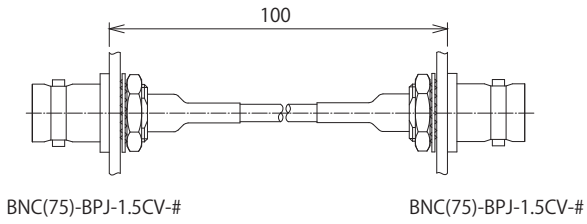

● PL71 Series

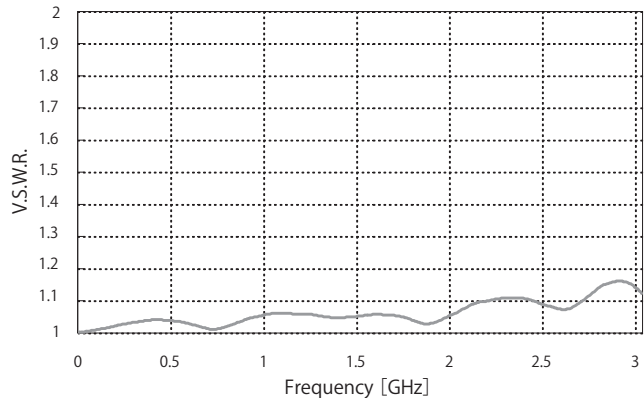
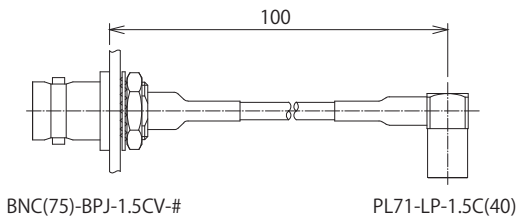

● PL75 Series

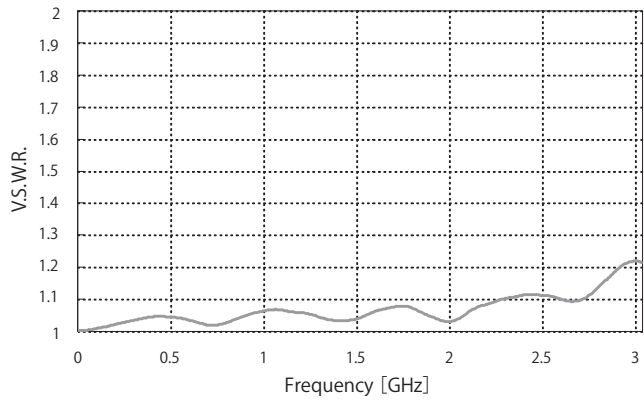
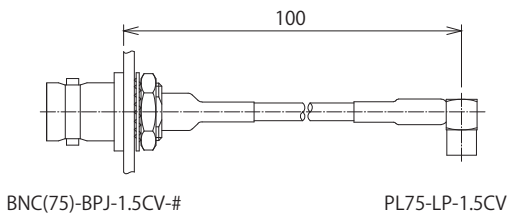

● H.FL75 Series

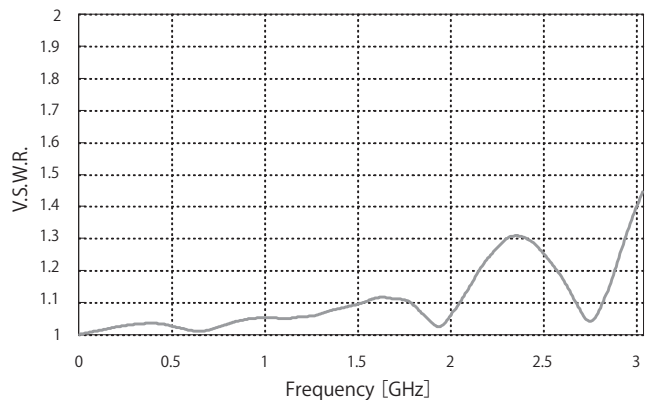
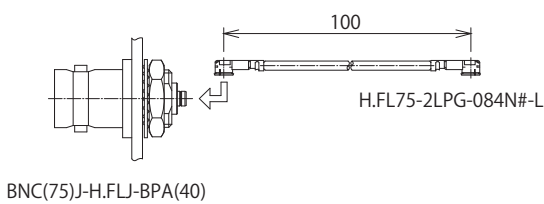

Extraction Tool

Tool for Unmating.

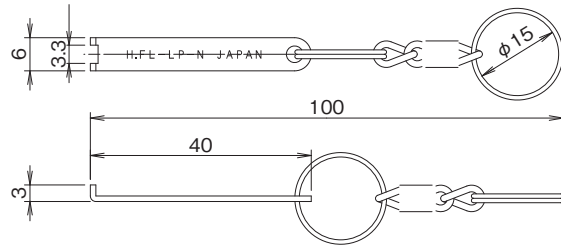

Part No.	HRS No.	Purchase Unit
H.FL-LP-N	CL0331-0551-7-00	1pc per bag

Usage Precautions

1. Plugs

1. Mating/Unmating

(1) To disconnect the connector, insert the edge of the extraction tool (H.FL-LP-N) under the connector flange.

Pull in a perpendicular direction in line with the connector's mating axis.

Do not unmate the plug by pulling on the cable, this can damage the connector performance.

(2) When mating, align the mating axes between the receptacle and cable assembly, and insert the cable assembly downward and perpendicular into the receptacle.

Do not insert the cable assembly at a slanted angle.

2. Tolerable Load to a Cable After Mating

Once the connector has been mated do not apply forces exceeding the values in the diagram below.

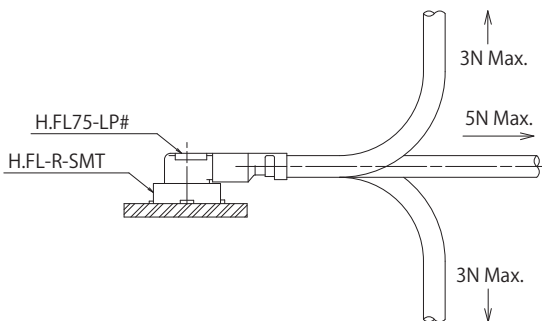

3. Precautions

Do not use excessive prying to mate or un-mate the connectors as it may lead to damage.

2. Receptacles

(1) Recommended Reflow Temperature Profile (Reference)	<p>1. Temperature refers to the temperature of the PCB surface at the terminal leads. 2. Reflow soldering should be performed at a printed circuit surface temperature of 250°C Max. 3. The temperature profile may vary depending on board size, solder used and solder thickness.</p>
(2) Recommended Manual Soldering Conditions	Manual soldering : 350°C for 5 seconds
(3) Recommended Metal Mask Thickness	0.1 to 0.15mm
(4) Reflow Cycles	Up to 2 times

3. Operating Environment and Storage Conditions

1. Operation Environment

This product was designed for use in a normal environment.

Please be advised that using this product in the environments described below may result in discoloration and other types of degradation.

- Exposure to excessive amounts of fine particles and dust.
- Regions/areas with a high concentration of gases like sulfur dioxide, hydrogen sulfide and nitrogen dioxide.
- Areas with drastic temperature changes, such as locations near a heater.

2. Storage Conditions

Store this product in Hirose's packaging or similar conditions.

Temperature : -10 to +40°C Humidity : 85% or less (recommended storage conditions)

We recommend the product be used within six months from delivery.

Products that have been stored beyond the recommended storage period need to be tested for mounting and solderability before use.

3. Silver Plating Discoloration

Discoloration occurs only on the plating surface. Since the contact portion is wiped, there is no effect on the electrical contact.

While Taking into Consideration

Specifications mentioned in this catalog are reference values.

When considering to order or use this product, please confirm the Drawing and Product Specifications sheets.

Use an appropriate cable when using the connector in combination with cables.

If considering usage of a non-specified cable, please contact your sales representative.

If assembly process is done by jigs & tools which are not identified by Hirose, assurance will not be given.

If considering usage for below mentioned applications, please contact your sales representative.

In cases where the application will demand a high level of reliability, such as automotive, medical instruments, public infrastructure, aerospace/ defense etc. Hirose must review before assurance of reliability can be given.