

# Ultra-Small Surface Mount Coaxial Connectors - 1.18mm Mated Height

## W.FL2 Series

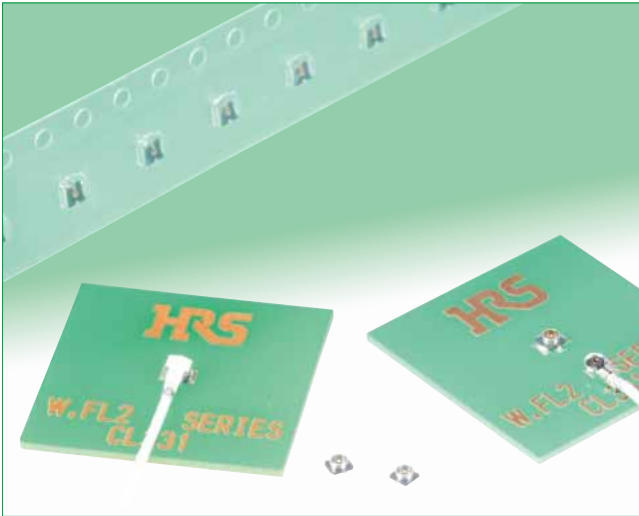

### Occupied Mounting Area

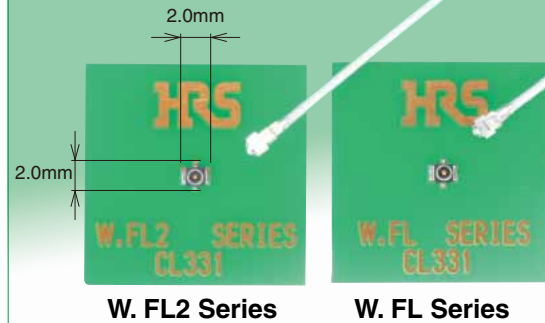

### Features

#### 1. Nominal mated height of 1.18mm (Max. 1.3mm)

#### 2. Small board footprint

As with X.FL, W.FL Series, the receptacles occupies an area of 3.4mm<sup>2</sup> and share the same land pattern.

Note : The W.FL2 Series is not compatible with X.FL, W.FL Series.

#### 3. Extremely light weight

The world's smallest and lightest class of coaxial connectors.

Receptacle : 5.0mg

Right angle plug : 17.4mg(040), 15.3mg(032)

#### 4. Frequency range up to 6 GHz

DC to 3GHz : V.S.W.R. of 1.3 max.

3GHz to 6GHz : V.S.W.R. of 1.4 max.(0.5, 0.81dia.)

3GHz to 6GHz : V.S.W.R. of 1.5 max.(0.64dia)

#### 5. Automatic board placement

Packaged on tape-and-reel the receptacles can be placed with vacuum nozzles of the automatic placement equipment.

#### 6. Plugs are terminated with ultra-fine coaxial (fluorinated resin insulated) cable

The use of ultra-fine coaxial (fluorinated resin insulated) cables on these connectors offer the ability to complete connections in small, confined spaces with a smooth, easy operation.

#### 7. Simple connector mating / un-mating

Use of the available mating / un-mating tools assures correct connection / disconnection of the plug and receptacle.

#### 8. Halogen-free\*(Receptacle, Plug)

\*As defined by IEC61249-2-21

Br-900 ppm maximum, Cl-900 ppm maximum,

Cl+Br combined-1,500 ppm maximum.

### Mated height comparison (with W.FL Series)

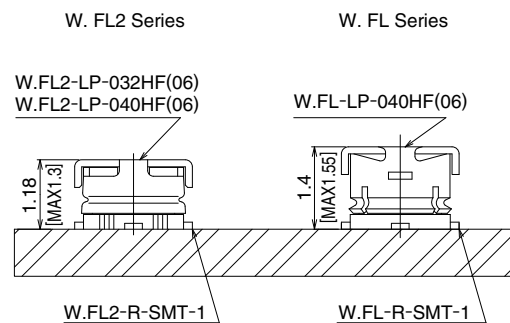

Fig.1

### W.FL2 Plug and Receptacle

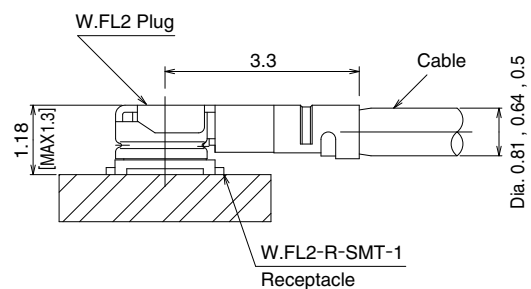

Fig.2

## Product Specifications

Rating	Nominal characteristic impedance	50Ω	Operating temperature range	-40°C to +90°C (90%RH max.)
	Frequency range	DC to 6GHz	Storage temperature range	-30°C to +70°C (90%RH max.)Note 1

Item	Specification
1. Contact resistance	20mΩ max. (center contact), 10mΩ max. (outer contact)
2. Insulation resistance	500MΩ min., 100V DC
3. Withstanding voltage	200V AC / 1 minute
4. V.S.W.R.	1.3 max. (DC to 3GHz)
	1.4 max. (3GHz to 6GHz) 0.5, 0.81dia.
	1.5 max. (3GHz to 6GHz) 0.64dia.

\* V.S.W.R. Measurement

as shown on the block diagram below.

Note: Verify connection and measurement setup.

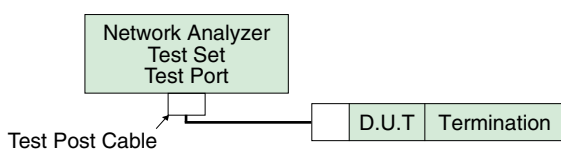

Note1 : Cable assembly measurements with SMA conversion adapters mated with W.FL2 plug at each end of the 100cm long ultra-fine coaxial cable.

Note2 : Receptacles mounted on a 50 ohms glass epoxy board. Measurements were conducted with SMA conversion adapters attached.

Note1. The term “storage” refers to products stored for long period of time prior to mounting and use.

## Materials / Finish

### Plugs – Right Angle

Part	Material	Finish
Shell	Phosphor bronze	Silver plated
Insulator	LCP	Color : Milky white, UL94V-0
Female center contact	Phosphor bronze	Gold plated

### Receptacle

Part	Material	Finish
Shell	Phosphor bronze	Silver plated
Insulator	LCP	Color : Black, UL94V-0
Male center contact	Brass	Gold plated

### ■ Cable Assembly(Plug)

W.FL2-LP-040HF(06) (Applicable cable : outer diameter 0.81, 0.64)

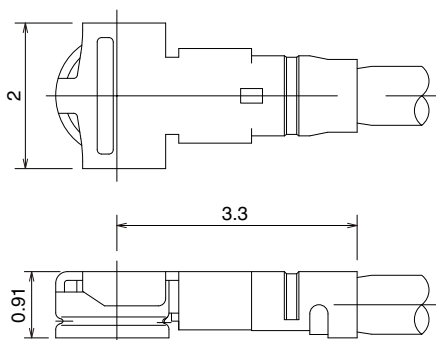

W.FL2-LP-032HF(06) (Applicable cable : outer diameter 0.5)

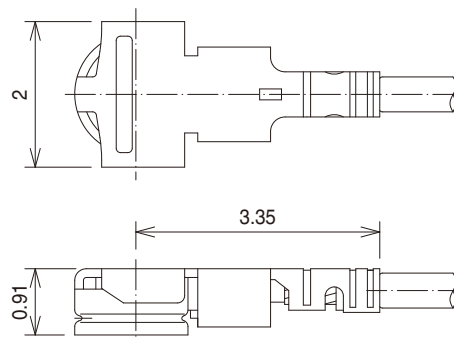

## How to specify Cable Assembly

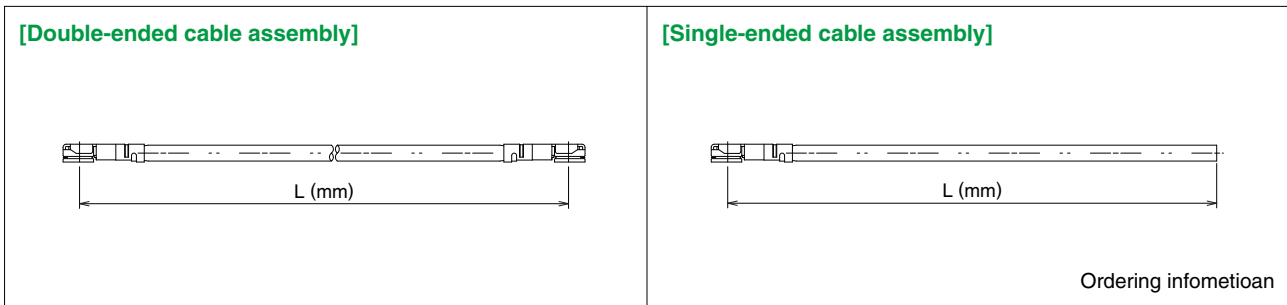

### Product Number Structure

Used plug : W.FL2-LP-040HF(06)

Double-Ended **W.FL2** - **2LP** - **HF6** - **04N** [ ] **TV** - **A** - **(L)**  
 1 2 3 4 5 6 7

Single-Ended **W.FL2** - **LP** - **HF6** - **04N** [ ] **TV** - **A** - **(L)**  
 1 2 3 4 5 6 7

### Standard Tolerances for (L)

(L)mm	Standard tolerance(mm)
*L=35 to 200	±4
L=200 to 500	±8
L=500 to 1000	±12
L=Longer than 1000mm	±1.5% of (L)

Note : Minimum available length(L) is 35mm.

1 Series name	: WFL2, W.FL2	4 Cable type	04N : 0.81mm dia. ultra-fine coaxial cable
2 Assembly type	LP : Single ended 2, 2LP : Double ended	5 Cable color	1 : White, 2 : Black
3 Environmental compliant	HF6 : Halogen-free	6 Cable outer conductor	TV : Tin Plated braided wire
		7 Total length (mm)	Length(L)

Used plug : W.FL2-LP-040HF(06)

Double-Ended **W.FL2** - **2LP** - **HF6** - **044N** [ ] **TS** - **A** - **(L)**  
 1 2 3 4 5 6 7

1 Series name	: WFL2, W.FL2	4 Cable type	044N, 044Y : 0.64mm dia. ultra-fine coaxial cable
2 Assembly type	2, 2LP : Double ended	5 Cable color	1 : White, 2 : Black
3 Environmental compliant	HF6 : Halogen-free	6 Cable outer conductor	TS : Tin Plated spiral wire
		7 Total length (mm)	Length(L)

Used plug : W.FL2-LP-032HF(06)

Double-Ended **W.FL2** - **2LP** - **HF6** - **032N** [ ] **TS** - **A** - **(L)**  
 1 2 3 4 5 6 7

1 Series name	: WFL2, W.FL2	4 Cable type	032N : 0.5mm dia. ultra-fine coaxial cable
2 Assembly type	2, 2LP : Double ended	5 Cable color	1 : White, 2 : Black
3 Environmental compliant	HF6 : Halogen-free	6 Cable outer conductor	TS : Tin Plated spiral wire
		7 Total length (mm)	Length(L)

## Receptacles

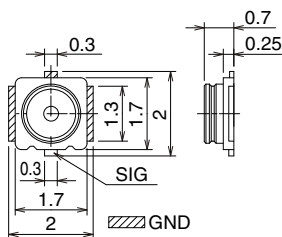
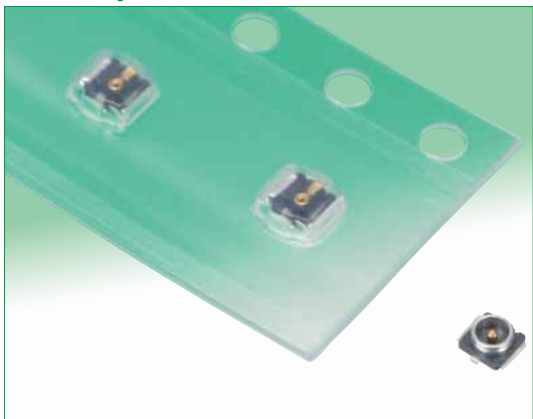

## Recommended PCB mounting pattern (Note 1)

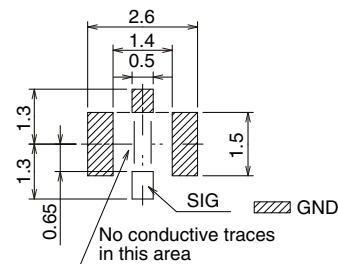

Note 1 : The land pattern is the same as that of the X.FL, W.FL series connectors.

Part No.	HRS No.	Packaging
W.FL2-R-SMT-1(60)	331-0315-4 60	Reel (5,000 pcs/reel)
W.FL2-R-SMT-1(80)	331-0315-4 80	Reel (10,000 pcs/reel)

## Embossed Carrier Tape Dimensions (IEC 60286-3 compliant)

Embossed Carrier Tape Dimensions

### Embossed Carrier Tape Dimensions

(W.FL2-R-SMT-1(60) 8mm pitch)

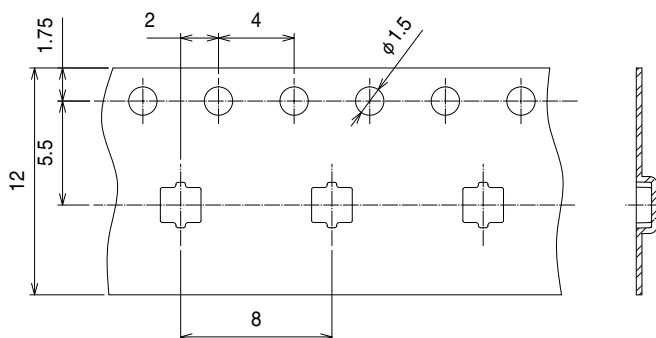

### Reel Dimensions

Material : PS(White)

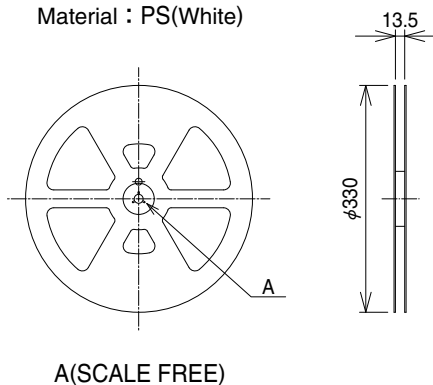

(W.FL2-R-SMT-1(80) 4mm pitch)

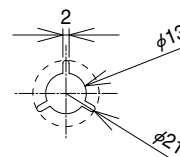
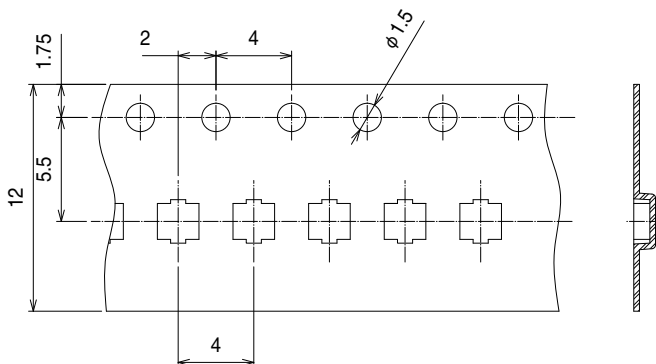

## ■ Conversion Adapters

### ● SMA Conversion Adapter (W.FL2 side jack – SMA side plug)



Note : Used for performance measurements only.  
The W.FL2 mating side has lower retention force when mated with the corresponding part.

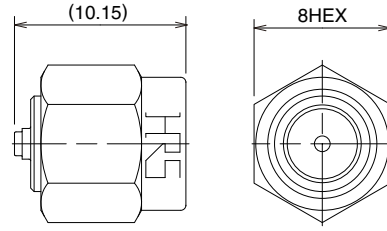

All dimensions : mm

Part No.	HRS No.	Packaging
HRMP-W.FL2J	311-0394-6	1

### ● SMA Conversion Adapter (W.FL2/W.FL side plug – SMA side jack)



Note : Used for performance measurements only.  
The W.FL/W.FL2 mating side has lower retention force when mated with the corresponding part.

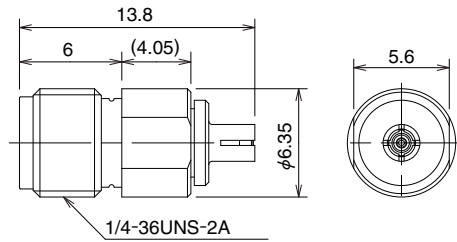

All dimensions : mm

Part No.	HRS No.	Packaging
HRMJ-W.FLP(40)	311-0368-6 40	1

### ● SMA Conversion Adapter



Note : When mating with corresponding part (W.FL2-R-SMT-1) must be pressed down and held to make complete connection.

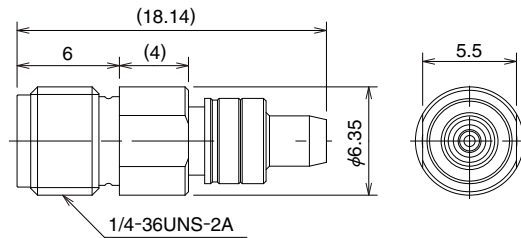

All dimensions : mm

Part No.	HRS No.	Packaging
HRMJ-W.FL2P-ST3	311-0417-0	1

## ■ Receptacle Inspection Adapter (W.FL2/W.FL)

Used for inspecting the performance parameters of the cable assembly.

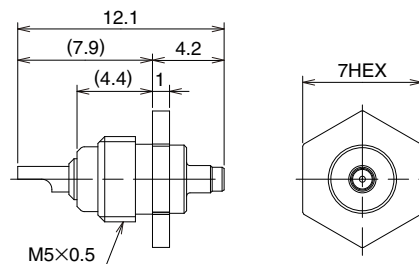
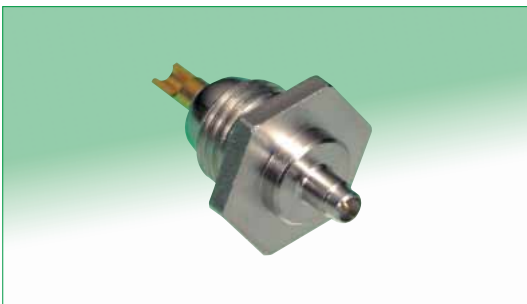

All dimensions : mm

Part No.	HRS No.	Packaging
W.FL-R-1	331-0483-9	1

**Tools**

**●Plug - Mating (Space saving type)**

This tool is used for mating a plug.

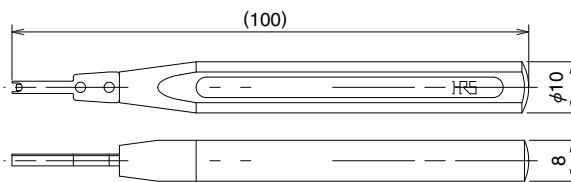

Part No.	HRS No.
W.FL-LP-IN	331-0323-2

Note : Can be used with W.FL, X.FL plugs.

**●Plug - Mating /Unmating (W.FL2-LP-040HF/032HF)**

This tool is for mating and unmating a plug.

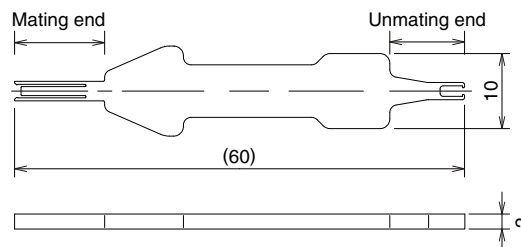
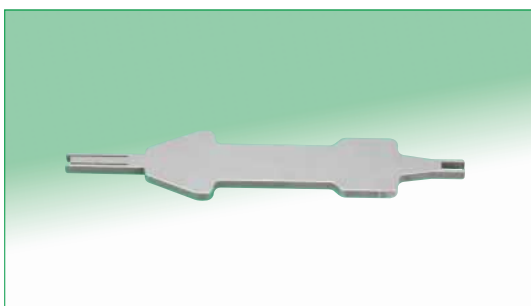

Part No.	HRS No.
W.FL2-LP-IN.OUT	331-0321-7

## Precautions

### 1. Plugs

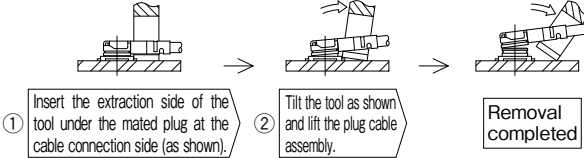
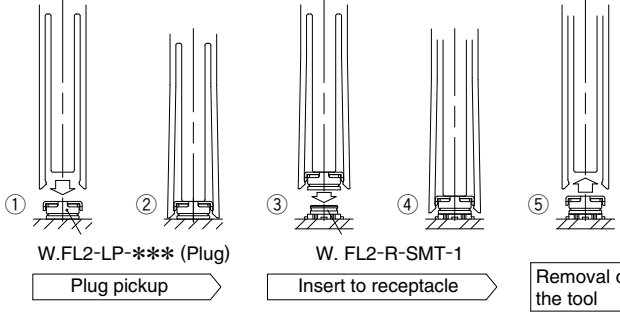
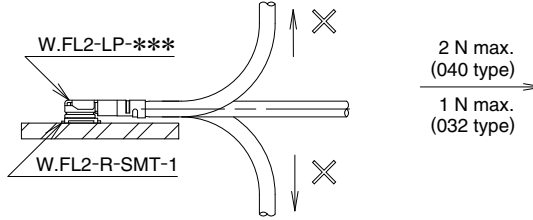
<p>(1) Mating / Unmating</p>	<p>① To disconnect connectors, insert the extraction side of insertion and extraction jig and perform as described in the diagram below.</p> <p><b>• Unmating</b></p>  <p><b>• Mating</b></p> <p>① Align the mating axes of the plug and the receptacle.          ② Confirm that the plug is positioned to be guided. (The both axes are aligned and the plug is positioned stably.)          ③ Remove the tool by carefully pulling it up.</p>  <p><b>● Use of the extraction tool is absolutely mandatory. Any attempt of unmating by pulling on the cable may result in damage and affect the mechanical / electrical performance.</b></p>
<p>(2) Pull forces on the cable after connectors are mated</p>	<p>Do not apply any pull forces after the bending of the cable.</p> 
<p>(3) Precautions</p>	<p>Do not twist connectors excessively during mating / unmating.</p>

### 2. Receptacles

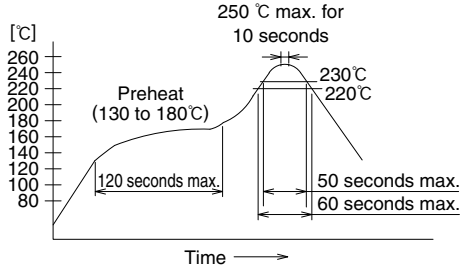
<p>(1) Recommended reflow temperature profile</p>	 <p>① The temperature of the printed circuit board surface temperature at the points of contact with the terminals.          ② Reflow soldering should be performed at a printed circuit surface temperature of 250°C max.          ③ In individual applications the actual temperature may vary, depending on the solder paste type, volume / thickness and board size / thickness. Consult your solder paste and equipment manufacturer for specific recommendations.</p>
<p>(2) Recommended metal mask thickness</p>	<p>0.1 mm to 0.12mm</p>
<p>(3) Reflow cycles</p>	<p>2 times</p>

### 3. Operating environment and storage conditions

<p>(1) Operating environment</p>	<p>The connectors are not designed to operate in the following environments:</p> <ul style="list-style-type: none"> <li>• Exposed to a excessive amounts of fine particles and dust</li> <li>• Regions and places having a high density of sulfur dioxide, hydrogen sulfide, nitrogen dioxide or other corrosive gasses.</li> <li>• Environments having large rapid variations in temperature.</li> </ul>
<p>(2) Storage conditions - Receptacle</p>	<p>Store in the Hirose Electric packaging.          Temperature : -10 to +40°C, Humidity : 85% max.          Use within 6 months of delivery.          Receptacles for which the storage period has elapsed must be tested for solderability to the PC board mounting surface.</p>



**HIROSE ELECTRIC CO.,LTD.**

2-6-3,Nakagawa Chuoh,Tsuzuki-Ku,Yokohama-Shi 224-8540,JAPAN  
 TEL: +81-45-620-3526 Fax: +81-45-591-3726  
<http://www.hirose.com>  
<http://www.hirose-connectors.com>