

Ultra-Small Surface Mount Coaxial Connectors - 1.18mm Mated Height

W.FL2 Series

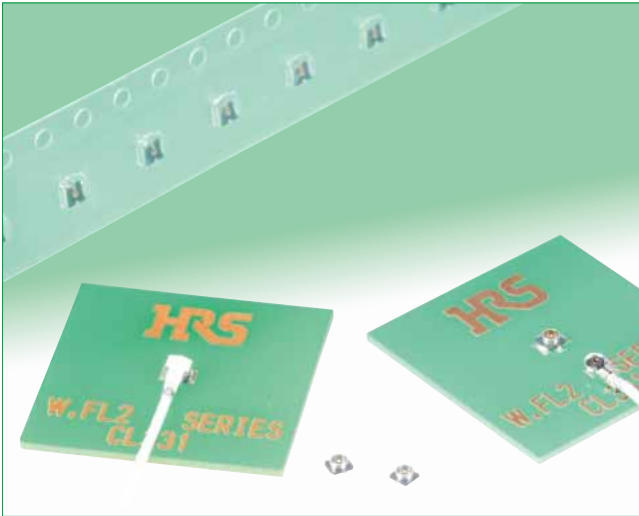

Occupied Mounting Area

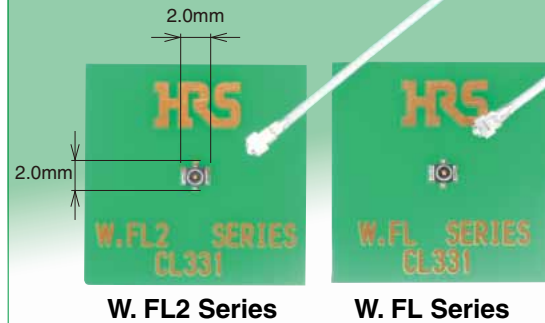

Features

1. Nominal mated height of 1.18mm (Max. 1.3mm)

2. Small board footprint

As with X.FL, W.FL Series, the receptacles occupies an area of 3.4mm² and share the same land pattern.

Note : The W. FL2 Series is not compatible with X.FL, W.FL Series.

3. Extremely light weight

The world's smallest and lightest class of coaxial connectors.

Receptacle : 5.0mg

Right angle plug : 17.4mg(040), 15.3mg(032)

4. Frequency range up to 6 GHz

DC to 3GHz : V.S.W.R. of 1.3 max.

3GHz to 6GHz : V.S.W.R. of 1.4 max.(0.5, 0.81dia.)

3GHz to 6GHz : V.S.W.R. of 1.5 max.(0.64dia)

5. Automatic board placement

Packaged on tape-and-reel the receptacles can be placed with vacuum nozzles of the automatic placement equipment.

6. Plugs are terminated with ultra-fine coaxial (fluorinated resin insulated) cable

The use of ultra-fine coaxial (fluorinated resin insulated) cables on these connectors offer the ability to complete connections in small, confined spaces with a smooth, easy operation.

7. Simple connector mating / un-mating

Use of the available mating / un-mating tools assures correct connection / disconnection of the plug and receptacle.

8. Halogen-free*(Receptacle, Plug)

*As defined by IEC61249-2-21

Br-900 ppm maximum, Cl-900 ppm maximum,

Cl+Br combined-1,500 ppm maximum.

Mated height comparison (with W.FL Series)

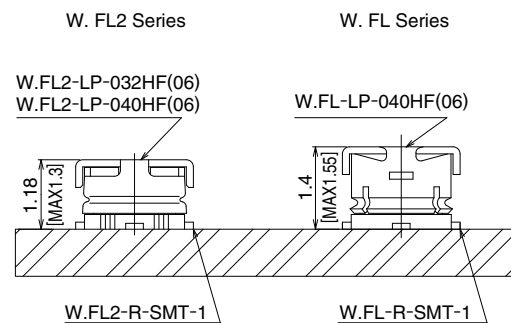

Fig.1

W.FL2 Plug and Receptacle

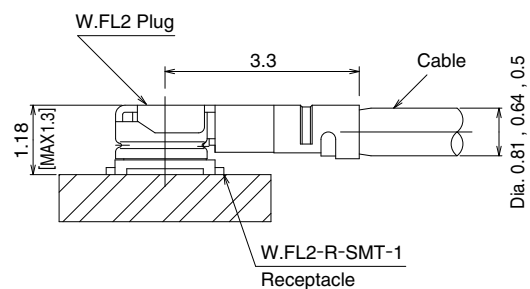

Fig.2

Product Specifications

Rating	Nominal characteristic impedance	50Ω	Operating temperature range	-40°C to +90°C (90%RH max.)
	Frequency range	DC to 6GHz	Storage temperature range	-30°C to +70°C (90%RH max.)Note 1

Item	Specification
1. Contact resistance	20mΩ max. (center contact), 10mΩ max. (outer contact)
2. Insulation resistance	500MΩ min., 100V DC
3. Withstanding voltage	200V AC / 1 minute
4. V.S.W.R.	1.3 max. (DC to 3GHz)
	1.4 max. (3GHz to 6GHz) 0.5, 0.81dia.
	1.5 max. (3GHz to 6GHz) 0.64dia.

* V.S.W.R. Measurement

as shown on the block diagram below.

Note: Verify connection and measurement setup.

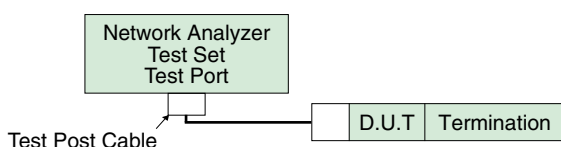

Note1 : Cable assembly measurements with SMA conversion adapters mated with W.FL2 plug at each end of the 100cm long ultra-fine coaxial cable.

Note2 : Receptacles mounted on a 50 ohms glass epoxy board. Measurements were conducted with SMA conversion adapters attached.

Note1. The term "storage" refers to products stored for long period of time prior to mounting and use.

Materials / Finish

Plugs – Right Angle

Part	Material	Finish
Shell	Phosphor bronze	Silver plated
Insulator	LCP	Color : Milky white, UL94V-0
Female center contact	Phosphor bronze	Gold plated

Receptacle

Part	Material	Finish
Shell	Phosphor bronze	Silver plated
Insulator	LCP	Color : Black, UL94V-0
Male center contact	Brass	Gold plated

■ Cable Assembly(Plug)

W.FL2-LP-040HF(06) (Applicable cable : outer diameter 0.81, 0.64)

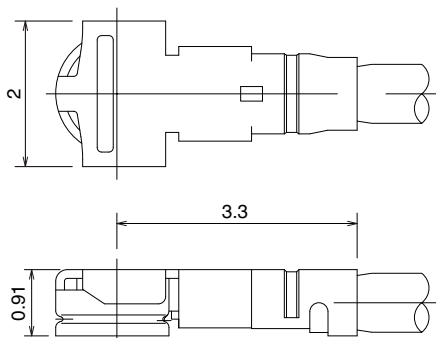

W.FL2-LP-032HF(06) (Applicable cable : outer diameter 0.5)

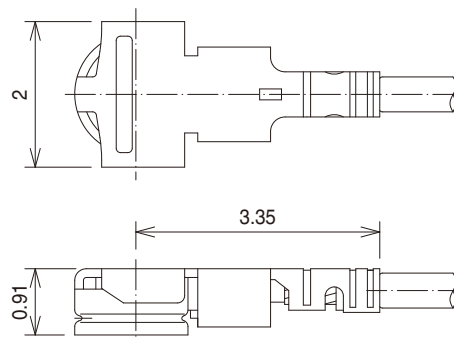

How to specify Cable Assembly

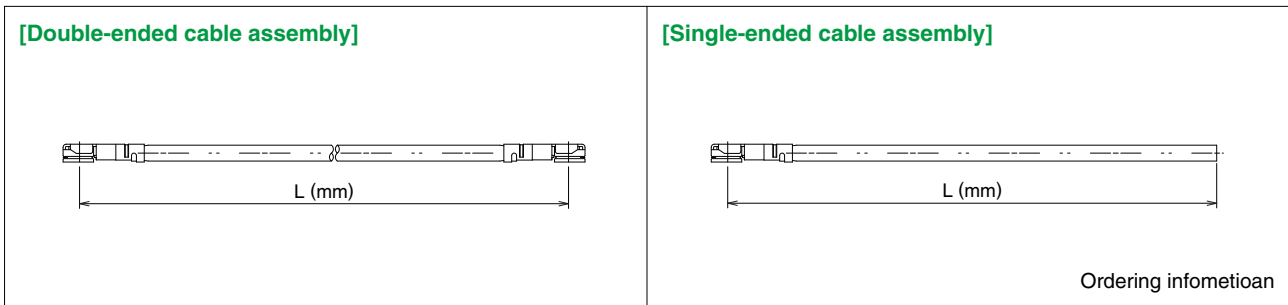

Product Number Structure

Used plug : W.FL2-LP-040HF(06)

Double-Ended W.FL2 - 2LP - HF6 - 04N [] TV - A - (L)
① ② ③ ④ ⑤ ⑥ ⑦

Single-Ended W.FL2 - LP - HF6 - 04N [] TV - A - (L)
① ② ③ ④ ⑤ ⑥ ⑦

Standard Tolerances for (L)

(L)mm	Standard tolerance(mm)
*L=35 to 200	±4
L=200 to 500	±8
L=500 to 1000	±12
L=Longer than 1000mm	±1.5% of (L)

Note : Minimum available length(L) is 35mm.

① Series name	: WFL2, W.FL2	④ Cable type	04N : 0.81mm dia. ultra-fine coaxial cable
② Assembly type	LP : Single ended 2, 2LP : Double ended	⑤ Cable color	1 : White, 2 : Black
③ Environmental compliant	HF6 : Halogen-free	⑥ Cable outer conductor	TV : Tin Plated braided wire
		⑦ Total length (mm)	Length(L)

Used plug : W.FL2-LP-040HF(06)

Double-Ended W.FL2 - 2LP - HF6 - 044N [] TS - A - (L)
① ② ③ ④ ⑤ ⑥ ⑦

① Series name	: WFL2, W.FL2	④ Cable type	044N, 044Y : 0.64mm dia. ultra-fine coaxial cable
② Assembly type	2, 2LP : Double ended	⑤ Cable color	1 : White, 2 : Black
③ Environmental compliant	HF6 : Halogen-free	⑥ Cable outer conductor	TS : Tin Plated spiral wire
		⑦ Total length (mm)	Length(L)

Used plug : W.FL2-LP-032HF(06)

Double-Ended W.FL2 - 2LP - HF6 - 032N [] TS - A - (L)
① ② ③ ④ ⑤ ⑥ ⑦

① Series name	: WFL2, W.FL2	④ Cable type	032N : 0.5mm dia. ultra-fine coaxial cable
② Assembly type	2, 2LP : Double ended	⑤ Cable color	1 : White, 2 : Black
③ Environmental compliant	HF6 : Halogen-free	⑥ Cable outer conductor	TS : Tin Plated spiral wire
		⑦ Total length (mm)	Length(L)

Receptacles

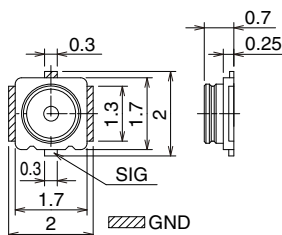
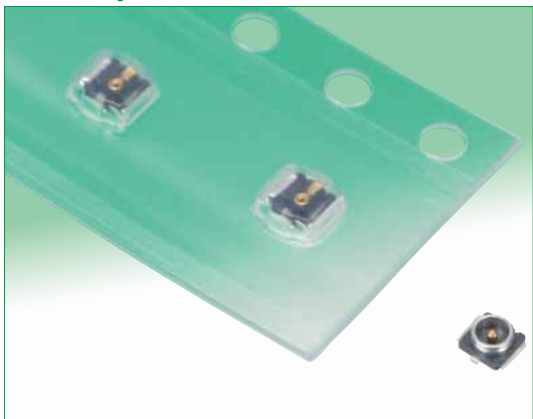

Recommended PCB mounting pattern (Note 1)

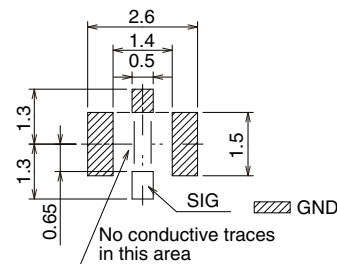

Note 1 : The land pattern is the same as that of the X.FL, W.FL series connectors.

Part No.	HRS No.	Packaging
W.FL2-R-SMT-1(60)	331-0315-4 60	Reel (5,000 pcs/reel)
W.FL2-R-SMT-1(80)	331-0315-4 80	Reel (10,000 pcs/reel)

Embossed Carrier Tape Dimensions (IEC 60286-3 compliant)

Embossed Carrier Tape Dimensions

Embossed Carrier Tape Dimensions

(W.FL2-R-SMT-1(60) 8mm pitch)

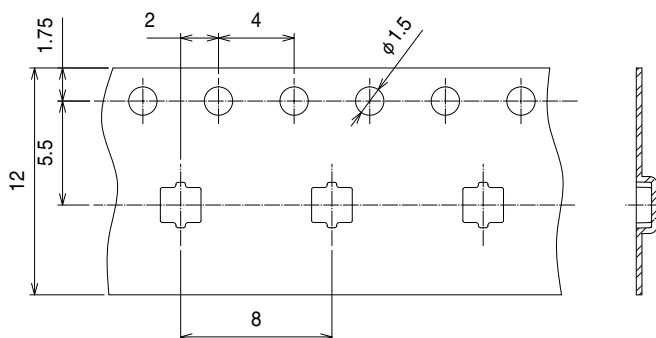

(W.FL2-R-SMT-1(80) 4mm pitch)

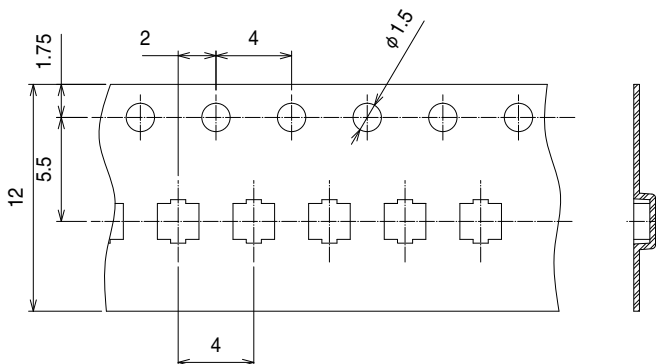

Reel Dimensions

Material : PS(White)

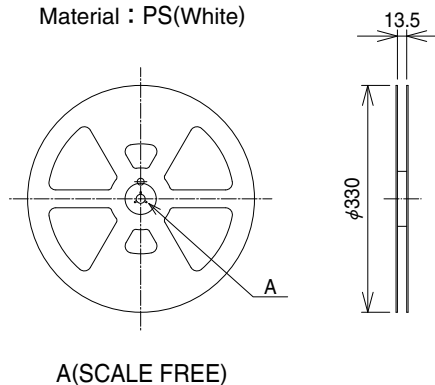

A(SCALE FREE)

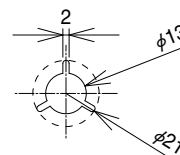

■ Conversion Adapters

● SMA Conversion Adapter (W.FL2 side jack – SMA side plug)



Note : Used for performance measurements only.
The W.FL2 mating side has lower retention force when mated with the corresponding part.

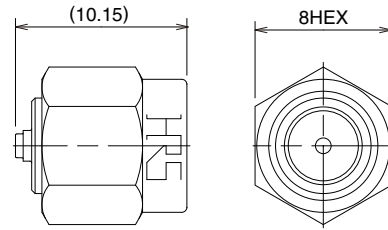

All dimensions : mm

Part No.	HRS No.	Packaging
HRMP-W.FL2J	311-0394-6	1

● SMA Conversion Adapter (W.FL2/W.FL side plug – SMA side jack)



Note : Used for performance measurements only.
The W.FL/W.FL2 mating side has lower retention force when mated with the corresponding part.

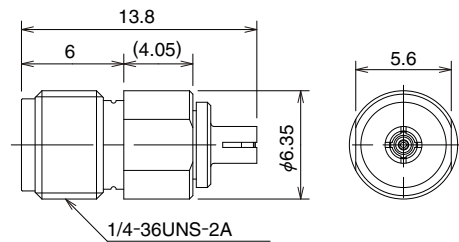

All dimensions : mm

Part No.	HRS No.	Packaging
HRMJ-W.FLP(40)	311-0368-6 40	1

● SMA Conversion Adapter



Note : When mating with corresponding part (W.FL2-R-SMT-1) must be pressed down and held to make complete connection.

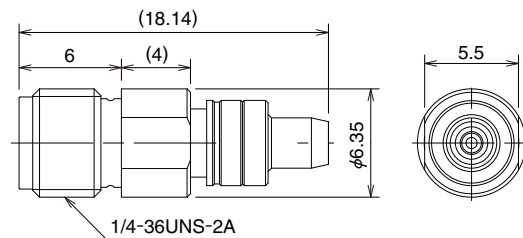

All dimensions : mm

Part No.	HRS No.	Packaging
HRMJ-W.FL2P-ST3	311-0417-0	1

■ Receptacle Inspection Adapter (W.FL2/W.FL)

Used for inspecting the performance parameters of the cable assembly.

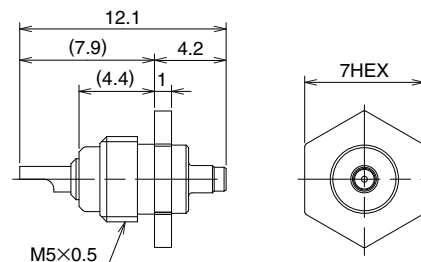
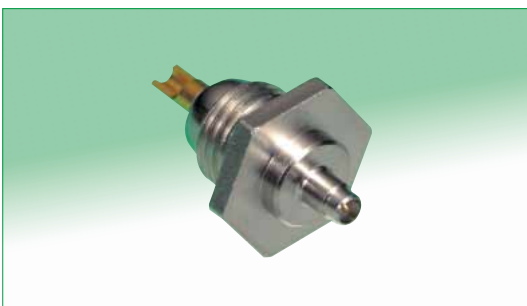

All dimensions : mm

Part No.	HRS No.	Packaging
W.FL-R-1	331-0483-9	1

Tools

●Plug - Mating (Space saving type)

This tool is used for mating a plug.

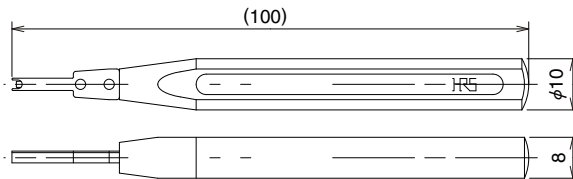

Part No.	HRS No.
W.FL-LP-IN	331-0323-2

Note : Can be used with W.FL, X.FL plugs.

●Plug - Mating /Unmating (W.FL2-LP-040HF/032HF)

This tool is for mating and unmating a plug.

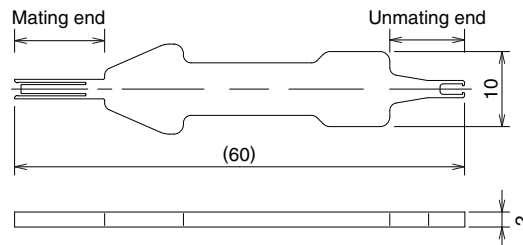
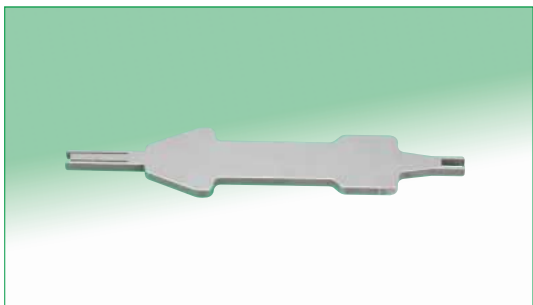

Part No.	HRS No.
W.FL2-LP-IN.OUT	331-0321-7

Precautions

1. Plugs

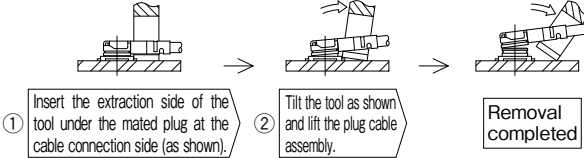
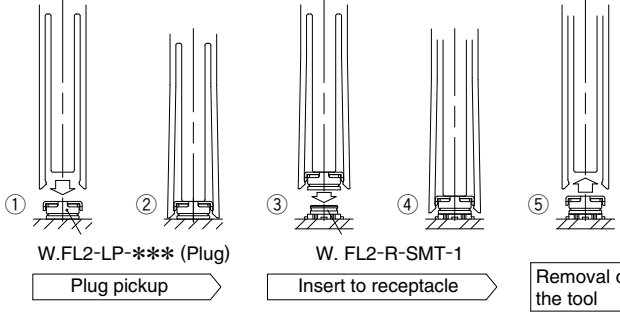
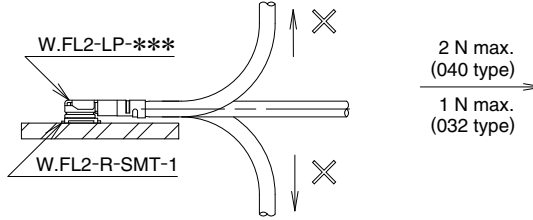
<p>(1) Mating / Unmating</p>	<p>① To disconnect connectors, insert the extraction side of insertion and extraction jig and perform as described in the diagram below.</p> <p>• Unmating</p>  <p>• Mating</p> <p>① Align the mating axes of the plug and the receptacle. ② Confirm that the plug is positioned to be guided. (The both axes are aligned and the plug is positioned stably.) ③ Remove the tool by carefully pulling it up.</p>  <p>● Use of the extraction tool is absolutely mandatory. Any attempt of unmating by pulling on the cable may result in damage and affect the mechanical / electrical performance.</p>
<p>(2) Pull forces on the cable after connectors are mated</p>	<p>Do not apply any pull forces after the bending of the cable.</p> 
<p>(3) Precautions</p>	<p>Do not twist connectors excessively during mating / unmating.</p>

2. Receptacles

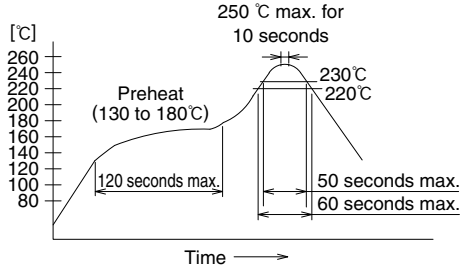
<p>(1) Recommended reflow temperature profile</p>	 <p>① The temperature of the printed circuit board surface temperature at the points of contact with the terminals. ② Reflow soldering should be performed at a printed circuit surface temperature of 250°C max. ③ In individual applications the actual temperature may vary, depending on the solder paste type, volume / thickness and board size / thickness. Consult your solder paste and equipment manufacturer for specific recommendations.</p>
<p>(2) Recommended metal mask thickness</p>	<p>0.1 mm to 0.12mm</p>
<p>(3) Reflow cycles</p>	<p>2 times</p>

3. Operating environment and storage conditions

<p>(1) Operating environment</p>	<p>The connectors are not designed to operate in the following environments:</p> <ul style="list-style-type: none"> • Exposed to a excessive amounts of fine particles and dust • Regions and places having a high density of sulfur dioxide, hydrogen sulfide, nitrogen dioxide or other corrosive gasses. • Environments having large rapid variations in temperature.
<p>(2) Storage conditions - Receptacle</p>	<p>Store in the Hirose Electric packaging. Temperature : -10 to +40°C, Humidity : 85% max. Use within 6 months of delivery. Receptacles for which the storage period has elapsed must be tested for solderability to the PC board mounting surface.</p>



HIROSE ELECTRIC CO.,LTD.

2-6-3,Nakagawa Chuoh,Tsuzuki-Ku,Yokohama-Shi 224-8540,JAPAN
 TEL: +81-45-620-3526 Fax: +81-45-591-3726
<http://www.hirose.com>
<http://www.hirose-connectors.com>