

Feb. 1. 2025 Copyright 2025 HIROSE ELECTRIC CO., LTD. All Rights Reserved.
 use of consideration for using Automotive equipment / device which demand high reliability, kindly contact our sales window correspond

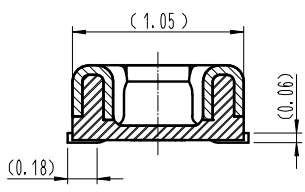

COUNT	DESCRIPTION OF REVISIONS	B	Y	CHKD	DATE	COUNT	DESCRIPTION OF REVISIONS	B	Y	CHKD	DATE
△						△					
△						△					
△						△					

ENGAGEMENT FIGURE (50:1)

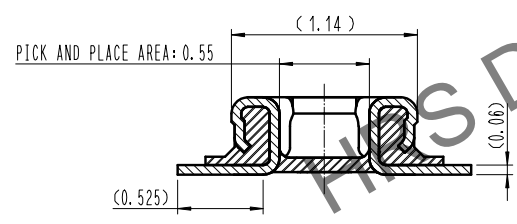
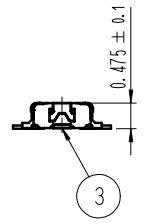
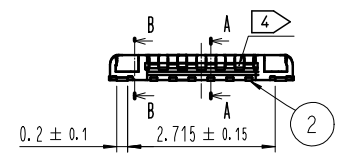
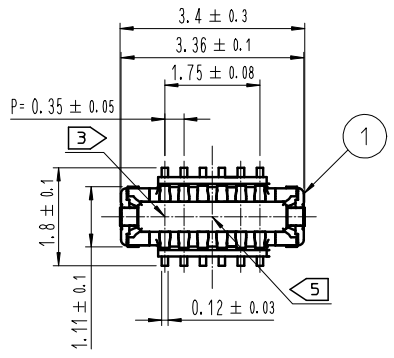
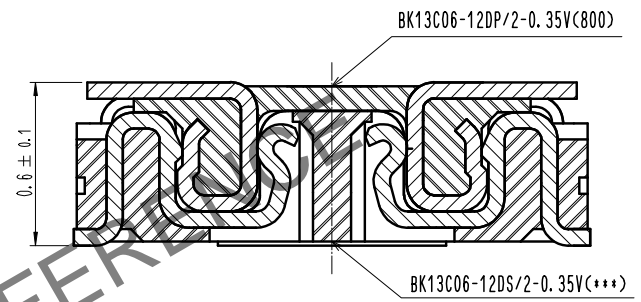

SIGNAL CONTACT

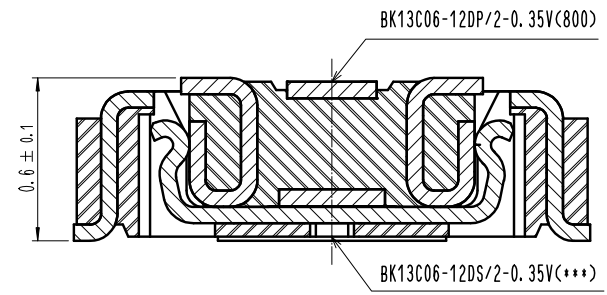

POWER CONTACT

- NOTE
- 1. ALL LEAD CO-PLANARITY SHALL BE 0.08mm MAX.
 - 2. CONTACT PLATING SPECIFICATIONS
 CONTACT AREA : GOLD 0.05 μm MIN
 SMT LEAD : GOLD 0.05 μm MIN
 UNDERPLATING : NICKEL 1 μm MIN
 (SURFACE : SEALING)
 - 3. CAV NO. ARE INDICATED IN APPROX POSITION SHOWN.
 - 4. A PART OF THE WALL COULD BE NOTCHED
 - 5. DENT EXISTS IN THE INDICATED AREA FOR MANUFACTURING CONVENIENCE.

4	PS	CLEAR (EMBOSSED CARRIER TAPE)								
3	COPPER ALLOY	2								
2	COPPER ALLOY	2				6	PS	BLACK (PLASTIC REEL)		
1	LCP	UL94 V-0, BLACK				5	POLYESTER	CLEAR (COVER TAPE)		
NO.	MATERIAL	FINISH . REMARKS	NO.	MATERIAL	FINISH . REMARKS	REMARKS				
						DRAWN	DESIGNED	CHECKED	APPROVED	RELEASED
						J. M. YEOM	J. M. YEOM	H. W. JO	H. W. JO	22.01.17
						22.01.17	22.01.17	22.01.17	22.01.17	22.01.17
CODE NO. (OLD)	DRAWING NO. EDC3-633576-80		PART NO. BK13C06-12DP/2-0.35V(800)							
	SCALE 10:1	HIROSE KOREA CO., LTD.		CODE NO. CL 6665-0060-7-800						
	UNITS									

Feb.1.2025 Copyright 2025 HIROSE ELECTRIC CO., LTD. All Rights Reserved.
In case of consideration for using Automotive equipment / device which demand high reliability, kindly contact our sales window correspondents.

7 **RECOMMENDED PCB LAYOUT**

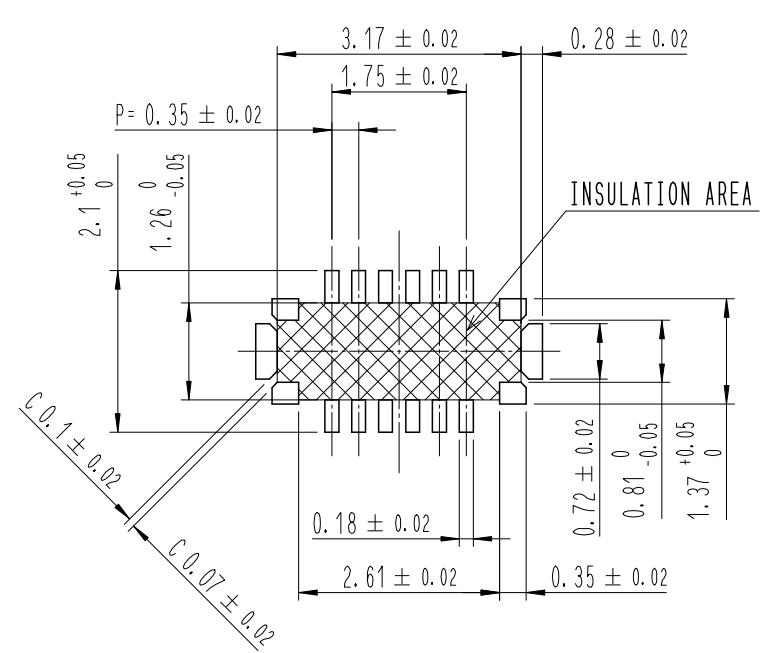

7 **RECOMMENDED METAL MASK DIMENSIONS**

METAL MASK THICKNESS : 80 μm

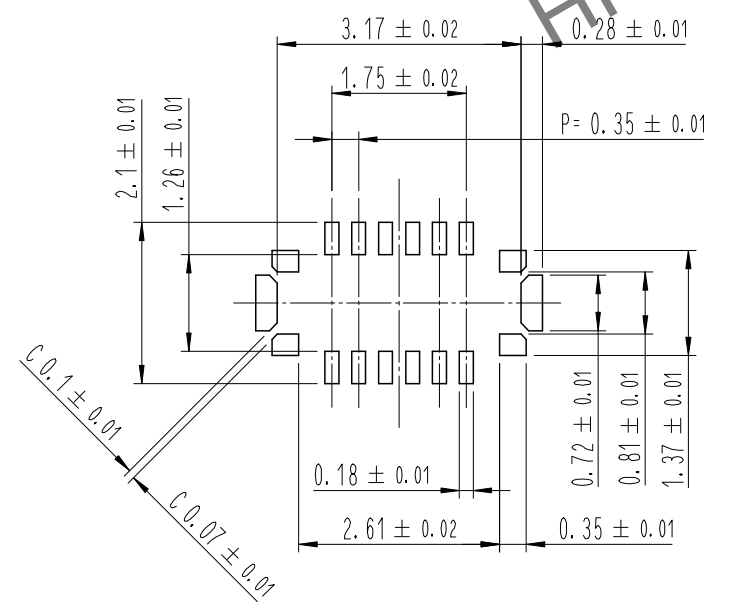

6 **RECOMMENDED REFLOW TEMPERATURE PROFILE USING LEAD-FREE SOLDER PASTE.**

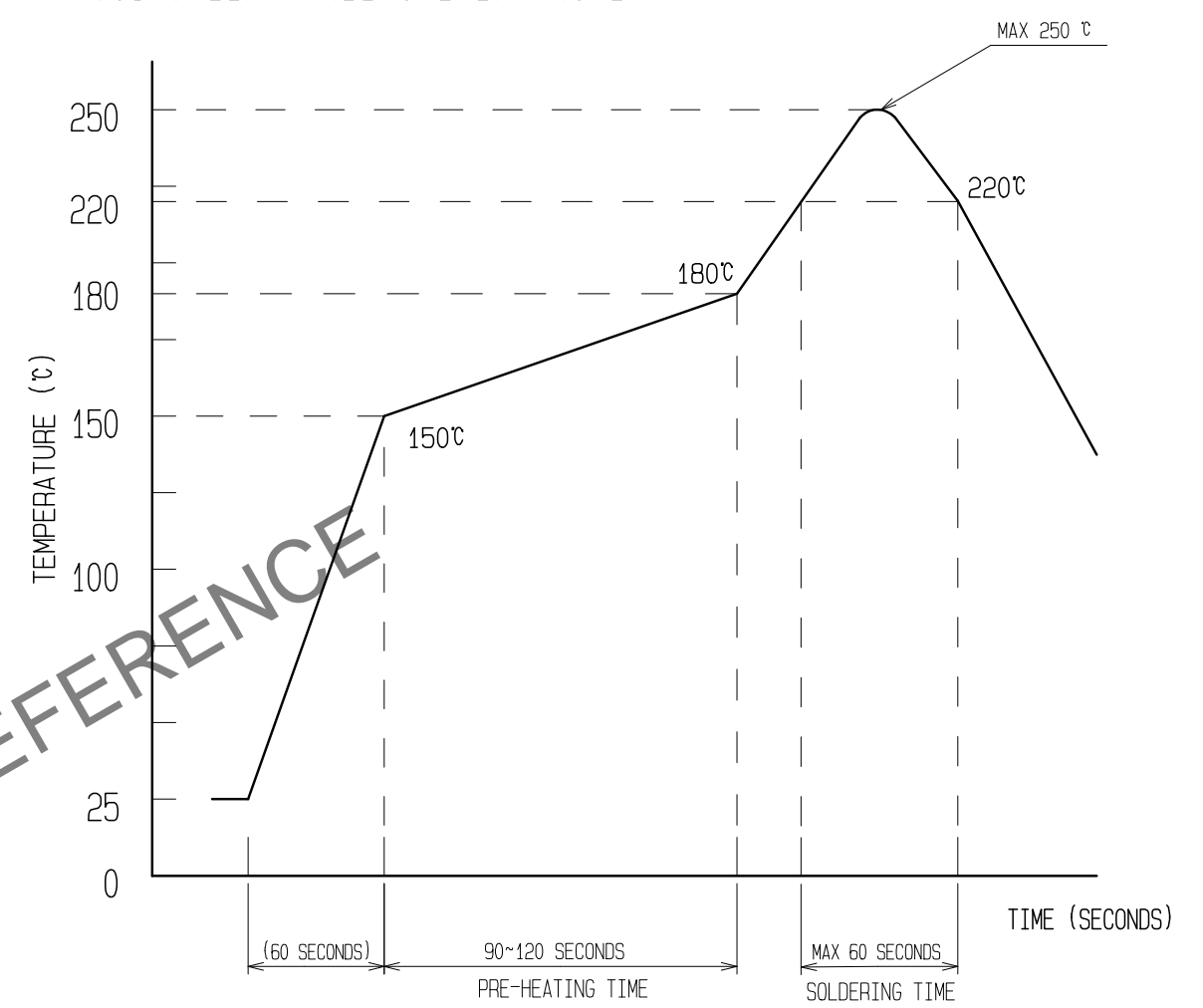

REFLOW METHOD : N₂ REFLOW
 NUMBER OF REFLOW CYCLES : 2 CYCLES MAX.
 1) REFLOW TIME
 DURATION ABOVE 220°C, 60 SEC MAX.
 (PEAK TEMPERATURE : 250°C MAX)
 2) PRE-HEAT TIME
 PRE-HEAT TEMPERATURE(MIN): 150°C
 PRE-HEAT TEMPERATURE(MAX): 180°C
 PRE-HEAT TIME: 90-120 SEC.

- 6 THIS TEMPERATURE PROFILE IS PER THE CONDITIONS SHOWN ABOVE. ADDITIONAL FACTORS SUCH AS SOLDER PASTE TYPE, PCB SIZE AND OTHER MOUNTED COMPONENTS COULD AFFECT THE PROFILE. THEREFORE, A THOROUGH EVALUATION OF MOUNTING CONDITION IS REQUIRED PRIOR TO PRODUCTION. TEMPERATURE IS MEASURED AT CONTACT LEAD.
- 7 PLEASE CONTACT US IN CASE YOU WILL MAKE DIFFERENT SETTINGS FROM OUR RECOMMENDATION.
- 8 THIS PRODUCT SATISFIES HALOGEN FREE REQUIREMENTS DEFINED AS 900ppm MAXIMUM CHLORINE, 900ppm MAXIMUM BROMINE, AND 1500ppm MAXIMUM TOTAL OF CHLORINE AND BROMINE.
- 9 THIS PRODUCT COMPLY WITH RoHS.

	DRAWING NO.	EDC3-633576-80	PART NO.	BK13C06-12DP/2-0.35V(800)
	SCALE	10:1	CODE NO	CL 6665-0060-7-800
UNITS	HIROSE KOREA CO., LTD.			2/3

Feb.1.2025 Copyright 2025 HIROSE ELECTRIC CO., LTD. All Rights Reserved.
In case of consideration for using Automotive equipment / device which demand high reliability, kindly contact our sales window correspondents.

EMBOSED CARRIER TAPE PACKAGING (5:1)

STYLE AND DIMENSION OF REEL (FREE)

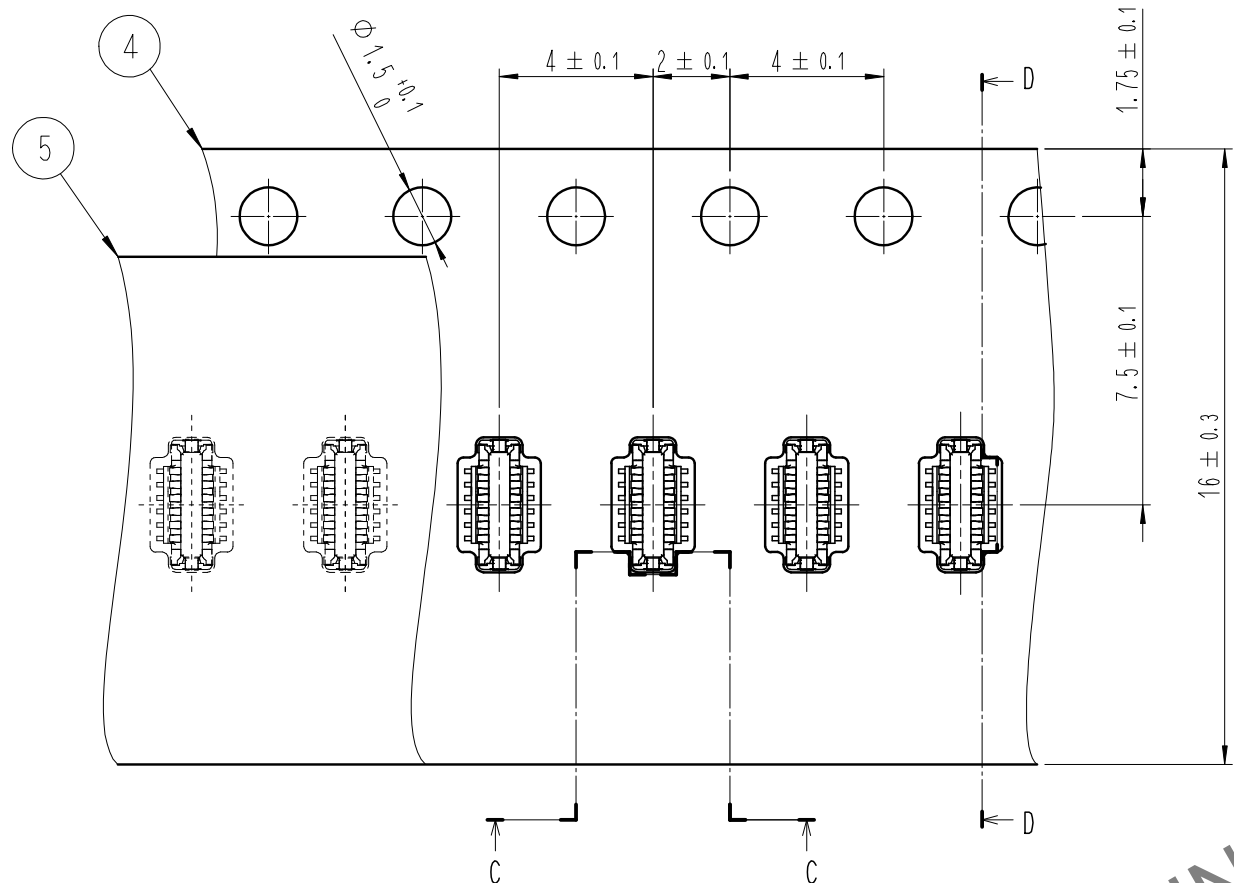

D-D (5:1)

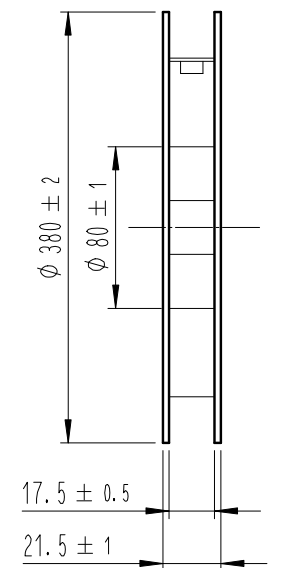
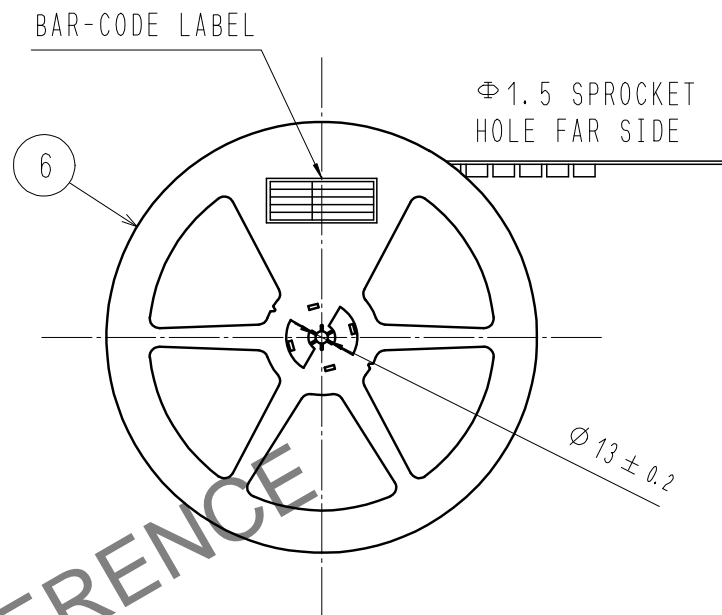
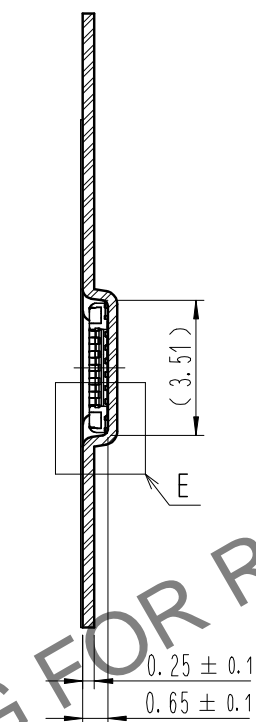

C-C (5:1)

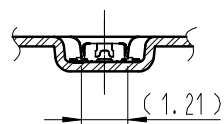

DIRECTION OF UNREELING

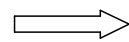

E (10:1)

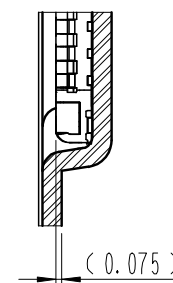

DETAIL OF PART No. LABEL

—	SUPPLIER	
—	QUANTITY	
—	PART NO.	
—	CODE NO.	
—	DATE OF MANUFACTURED	
—	生産月日	年 月 日
—	図番	** ** *
—	品名	BK13C06-12DP/2-0.35V(800)
—	納入数量	20,000個
—	納入者	HIROSE KOREA

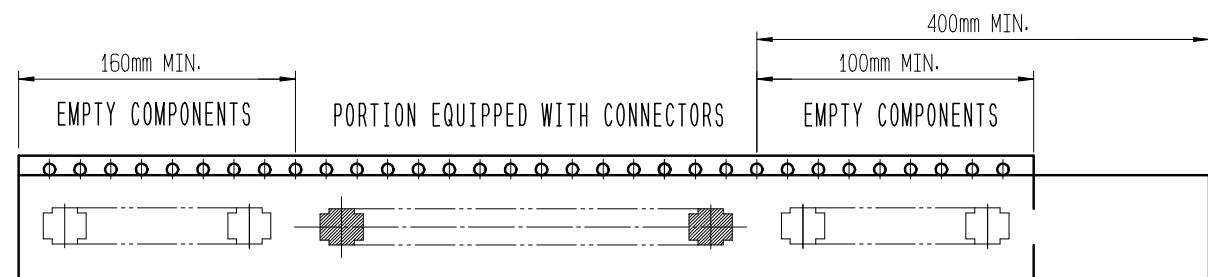

TRAILER

LEADER

TAPING(FREE)

10 . PER REEL 20,000 CONNECTORS.

11 . THE DIMENSIONS IN PARENTHESES ARE FOR REFERENCE.

12 > REFER TO JIS C 0806, IEC-60286-3 (PACKAGING OF COMPONENTS FOR AUTOMATIC HANDLING)

	DRAWING NO.	EDC3-633576-80	PART NO.	BK13C06-12DP/2-0.35V(800)
	SCALE	10:1	CODE NO.	CL 6665-0060-7-800
UNITS	HIROSE KOREA CO., LTD.			3/3