

# 2.54mm Pitch Card Edge Connector

## CR22 Series

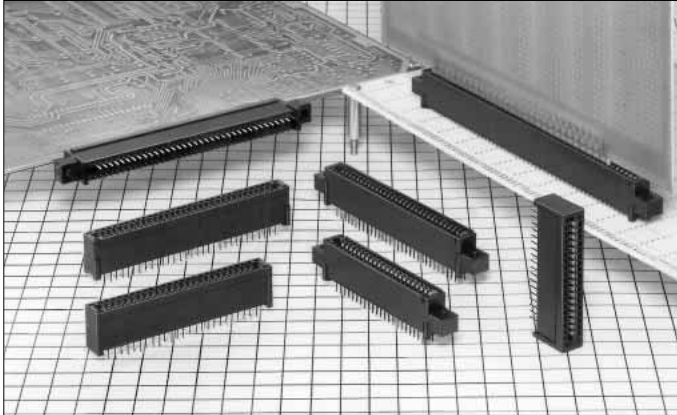

### ■ Features

1. 2.54mm pitch Contact

2. Variation in number of contacts

20, 30, 34, 36, 44, 50, 60, 62, 68, 72, 80, 100, and 120 contacts are available.

3. Board Mount Type

Straight dip and right angle through hole types are available.

4. To prevent mis-insertion in the board

Using the polarizing key prevents mis-insertion in the printed board.

### ■ Product Standards

Rating	Current rating: 3A Voltage rating: 300VAC	Operating Temperature Range: -30 to +85°C (Note 1) Operating Humidity Range: 40 to 80%	Storage Temperature Range: -10 to +60°C (Note 2) Storage Humidity Range: 40 to 70% (Note 2)
--------	--	---	--

Item	Specification	Condition
1. Insulation Resistance	1000M ohms min.	500V DC
2. Withstanding Voltage	No flashover or insulation breakdown.	1000V AC/1 minute.
3. Contact Resistance	20m ohms max.	100mA
4. Vibration	No electrical discontinuity of 10μs or more	Frequency: 10 to 55 Hz, single amplitude of 0.75 mm, 2 hours in each of the 3 directions.
5. Humidity (Steady state)	Insulation resistance : 1000M ohms min.	96 hours at temperature of 40°C and humidity of 90% to 95%
6. Temperature Cycle	No damage, cracks, or parts looseness.	(-65°C : 30 minutes → 15 to 35°C : 5 minutes max. → 125°C : 30 minutes → 15 to 35°C : 5 minutes max.) 5 cycles
7. Durability (Mating/un-mating)	Contact resistance : 20m ohms max.	500 cycles
8. Resistance to Soldering heat	No deformation of components affecting performance.	Manual soldering: 350°C for 3 seconds

Note 1: Includes temperature rise caused by current flow.

Note 2: The term "storage" refers to products stored for long period of time prior to mounting and use. Operating Temperature Range and Humidity range covers non conducting condition of installed connectors in storage, shipment or during transportation.

Note 3: Information contained in this catalog represents general requirements for this Series. Contact us for the drawings and specifications for a specific part number shown.

### ■ Material

Parts	Material	Finish	Remarks
Insulator	PBT	Black	UL94V-0
Contact	Copper alloy	Contact area	Selective gold plated
		Lead area	Tin plated

### ■ Ordering Information

**CR22**   **A** - **50**   **D** - **2.54**   **DS**

①   ②   ③   ④   ⑤   ⑥

① Series Name : CR22	③ Number of contacts : 20, 30, 34, 36, 44, 50, 60, 62, 68, 72, 80, 100, 120
② Blank : With Mounting hole A : Without mounting hole B : Card Edge 7.62mm type with mounting hole C : Card Edge 7.62mm type without mounting hole D : VERSA bus type with mounting hole E : VERSA bus type without mounting hole	
	④ Contact alignment : D : Double side
	⑤ Contact pitch : 2.54mm
	⑥ Contact type DS : Straight type DSA : Right angle type

## ■Straight Through hole Type

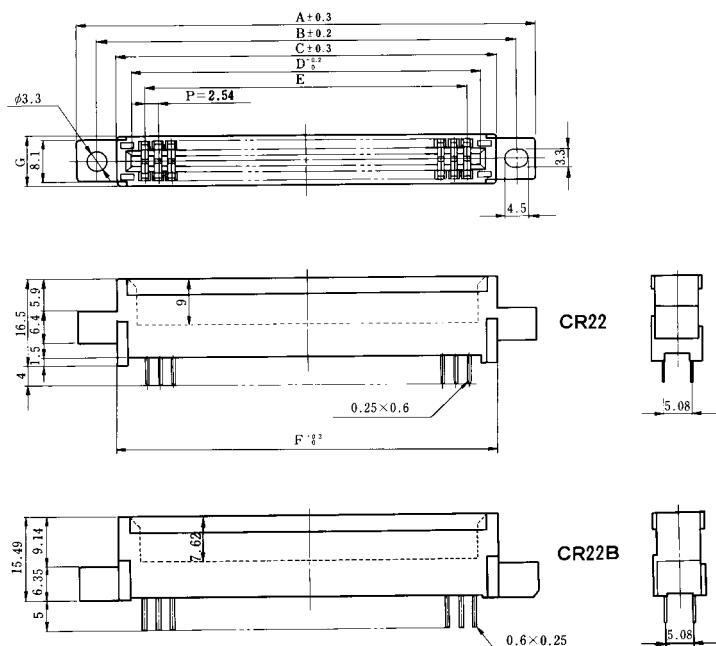
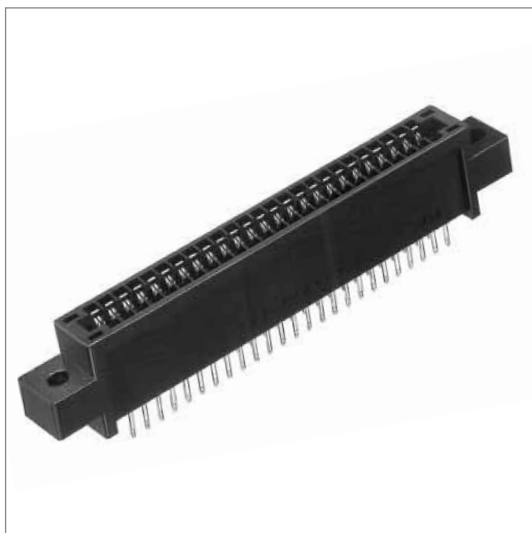

Unit: mm

Part Number	CL No.	Number of Contacts	A	B	C	D	E	F	G	RoHS
CR22 - 20D-2.54DS(70)	CL522-0063-9-70	20	49.04	41.44	34.04	27.94	22.86	34.04	9.5	YES
CR22 - 30D-2.54DS(70)	CL522-0009-3-70	30	61.74	54.14	46.74	40.64	35.56	46.74	9.5	
CR22 - 34D-2.54DS(70)	CL522-0011-5-70	34	66.82	59.22	51.82	45.72	40.64	51.82	9.5	
CR22 - 44D-2.54DS(70)	CL522-0001-1-70	44	79.52	71.92	64.52	58.42	53.34	64.52	9.5	
CR22 - 50D-2.54DS(70)	CL522-0003-7-70	50	87.14	79.54	72.14	66.04	60.96	72.14	9.5	
CR22B- 50D-2.54DS(70)	CL522-0047-2-70		84.71	78.11	70.1	66.04	60.96	70.1	9.4	
CR22 - 68D-2.54DS(70)	CL522-0017-1-70	68	110	102.4	95	88.9	83.82	95	9.5	
CR22 - 72D-2.54DS(70)	CL522-0019-7-70	72	115.08	107.48	100.08	93.98	88.9	100.08	9.5	
CR22 - 80D-2.54DS(70)	CL522-0049-8-70	80	125.24	117.64	110.24	104.14	99.06	110.24	9.5	
CR22 - 100D-2.54DS(70)	CL522-0005-2-70	100	150.64	143.04	135.64	129.54	124.46	135.64	9.5	
Note CR22D-120D-2.54DS(70)	CL522-0053-5-70	120	176.04	168.44	161.04	154.75	149.86	161.04	10	

Note : The 120 contacts type differs in configuration.

## ■Straight Through hole Type

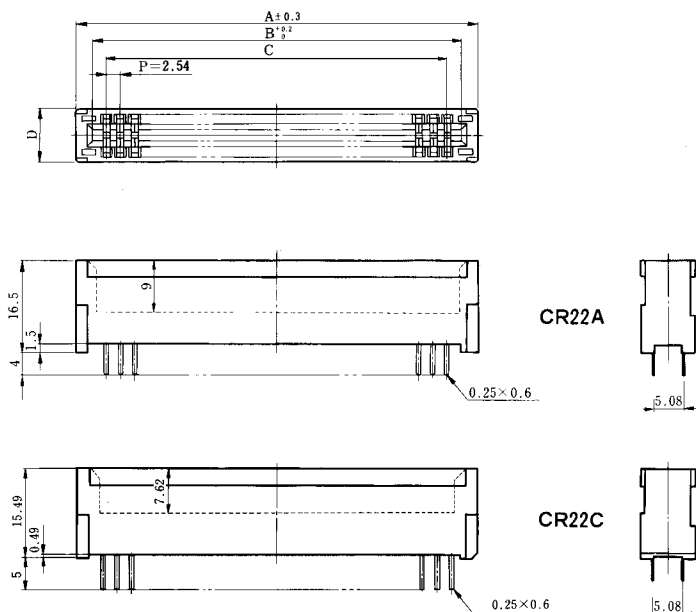
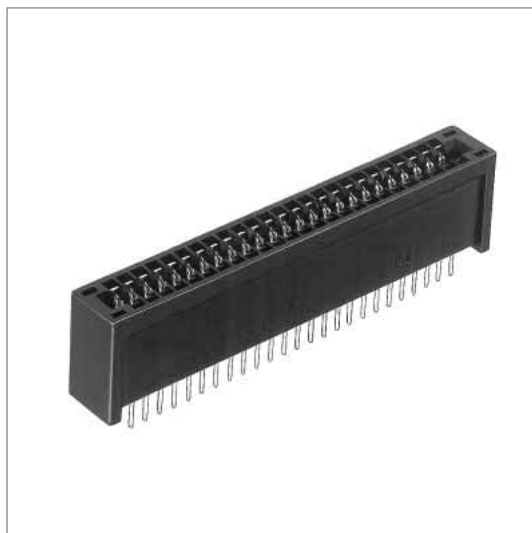

Unit: mm

Part Number	CL No.	Number of Contacts	A	B	C	D	RoHS
CR22A- 20D-2.54DS(70)	CL522-0064-1-70	20	34.04	27.94	22.86	9.5	YES
CR22A- 30D-2.54DS(70)	CL522-0010-2-70	30	46.74	40.64	35.56	9.5	
CR22A- 34D-2.54DS(70)	CL522-0012-8-70	34	51.82	45.72	40.64	9.5	
CR22A- 36D-2.54DS(70)	CL522-0008-0-70	36	54.36	48.26	43.18	9.5	
CR22C- 36D-2.54DS(70)	CL522-0072-0-70		52.32	48.26	43.18	9.4	
CR22A- 44D-2.54DS(70)	CL522-0002-4-70	44	64.52	58.42	53.34	9.5	
CR22A- 50D-2.54DS(70)	CL522-0004-0-70	50	72.14	66.04	60.96	9.5	
CR22C- 50D-2.54DS(70)	CL522-0048-5-70		70.1	66.04	60.96	9.4	
CR22A- 60D-2.54DS(70)	CL522-0014-3-70	60	84.84	78.74	73.66	9.5	
CR22A- 62D-2.54DS(70)	CL522-0016-9-70	62	87.38	81.28	76.2	9.5	
CR22C- 62D-2.54DS(70)	CL522-0060-0-70		85.34	81.28	76.2	9.4	
CR22A- 68D-2.54DS(70)	CL522-0018-4-70	68	95	88.9	83.82	9.5	
CR22A- 72D-2.54DS(70)	CL522-0020-6-70	72	100.08	93.98	88.9	9.5	
CR22A- 80D-2.54DS(70)	CL522-0050-7-70	80	110.24	104.14	99.06	9.5	
CR22A-100D-2.54DS(70)	CL522-0006-5-70	100	135.64	129.54	124.46	9.5	
Note CR22E-120D-2.54DS(70)	CL522-0054-8-70	120	161.04	154.75	149.86	10	

Note : The 120 contacts type differs in configuration.

Right Angle Through hole Type

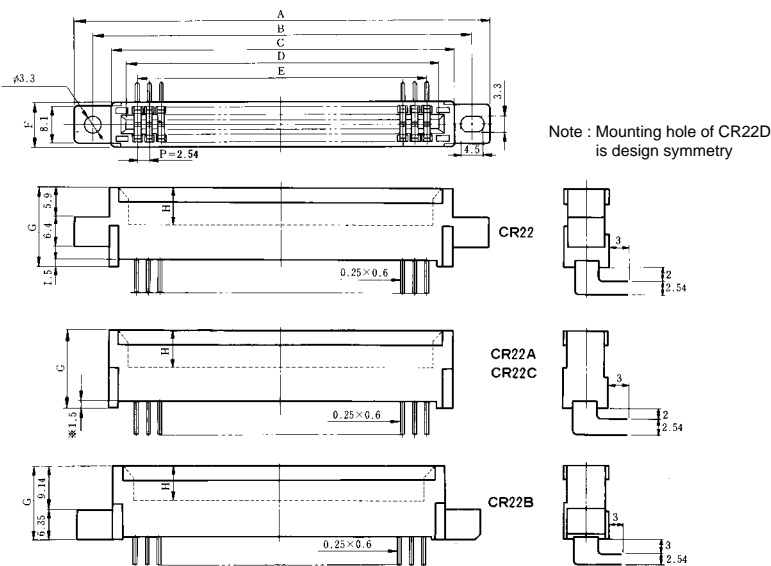

Unit: mm

Part Number	CL No.	Number of Contacts	A	B	C	D	E	F	G	H	RoHS
CR22 - 30D-2.54DSA(70)	CL522-0023-4-70	30	61.74	54.14	46.74	40.64	35.56	9.5	16.5	9	YES
CR22A- 30D-2.54DSA(70)	CL522-0034-0-70		—	—	46.74	40.64	35.56	9.5	16.5	9	
CR22 - 34D-2.54DSA(70)	CL522-0024-7-70	34	66.82	59.22	51.82	45.72	40.64	9.5	16.5	9	
CR22A- 34D-2.54DSA(70)	CL522-0035-3-70		—	—	51.82	45.72	40.64	9.5	16.5	9	
CR22 - 36D-2.54DSA(70)	CL522-0025-0-70	36	69.36	61.76	54.36	48.26	43.18	9.5	16.5	9	
CR22A- 44D-2.54DSA(70)	CL522-0037-9-70	44	—	—	64.52	58.42	53.34	9.5	16.5	9	
CR22 - 50D-2.54DSA(70)	CL522-0027-5-70	50	87.14	79.54	72.14	66.04	60.96	9.5	16.5	9	
CR22B- 50D-2.54DSA(70)	CL522-0045-7-70		84.71	78.11	70.1	66.04	60.96	9.4	15.49	7.62	
CR22 - 60D-2.54DSA(70)	CL522-0028-8-70	60	99.84	92.24	84.84	78.74	73.66	9.5	16.5	9	
CR22 - 62D-2.54DSA(70)	CL522-0029-0-70	62	102.38	94.78	87.38	81.28	76.2	9.5	16.5	9	
CR22A- 62D-2.54DSA(70)	CL522-0040-3-70		—	—	87.38	81.28	76.2	9.5	16.5	9	
CR22 - 68D-2.54DSA(70)	CL522-0030-0-70	68	110	102.4	95.00	88.9	83.82	9.5	16.5	9	
CR22 - 72D-2.54DSA(70)	CL522-0031-2-70	72	115.08	107.48	100.08	93.98	88.9	9.5	16.5	9	
CR22 -100D-2.54DSA(70)	CL522-0033-8-70	100	150.64	143.04	135.64	129.54	124.46	9.5	16.5	9	
CR22A-100D-2.54DSA(70)	CL522-0044-4-70		—	—	135.64	129.54	124.46	9.5	16.5	9	

### PCB Dimensions

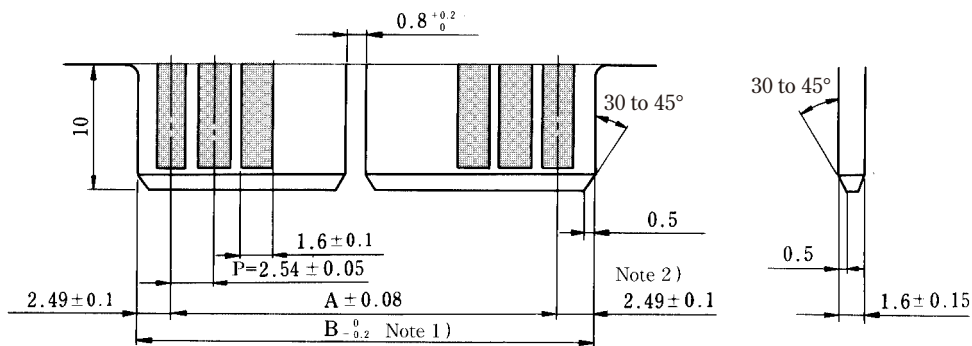

Note 1. The 120 contacts type indicates  $154.69_{-0.25}^0$ .

Note 2. The 120 contacts type indicates 2.415.

Unit: mm

Number of Contacts	12	30	34	36	44	50	60	62	68	72	80	100	120
A	22.86	35.56	40.64	43.18	53.34	60.96	73.66	76.2	83.82	88.9	99.06	124.46	149.86
B	27.84	40.54	45.62	48.16	58.32	65.94	78.64	81.18	88.80	93.88	104.04	129.44	154.69

### Polarizing Key

CR13-GPIN(A)

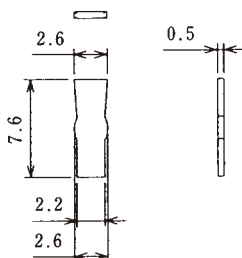

Part Number	CL No.	Material	Color	RoHS
CR13-GPIN(A)	513-0010-1	Polyacetal	White	YES

Note: Using the polarizing key prevents mis-insertion in the printed board.

To use the polarizing key, insert the polarizing key so as to hit the mold bottom.

### PCB mounting pattern

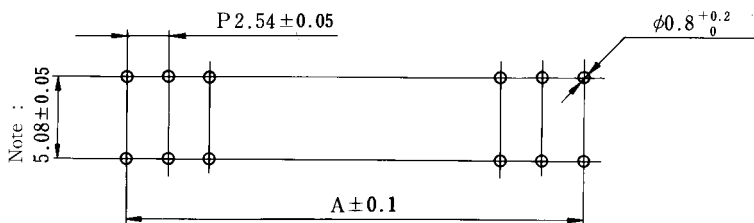

Unit: mm

Number of Contacts	12	30	34	36	44	50	60	62	68	72	80	100	120
A	22.86	35.56	40.64	43.18	53.34	60.96	73.66	76.2	83.82	88.9	99.06	124.46	149.86

Note : The contact DSA type indicates 2.54mm±0.05.