

2mm Pitch Connector Directly Mounted on Board

DF4 Series

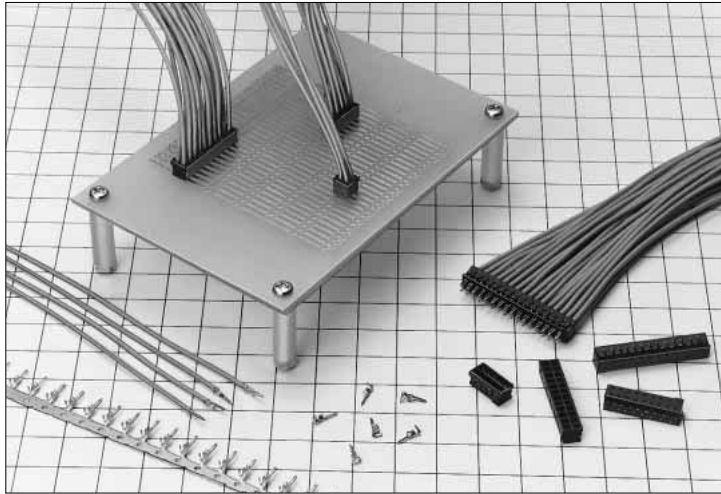

■ Features

1. Cost Saving for Header

Thanks to the insertion/extraction socket and the harness product at the both connector edges, one of two headers necessary at both edge sockets can be saved without losing the function to separate individual boards.

2. Miniature and Multiple Contacts

The miniature connector has broad variations in contact number.

Board mounting height : **4.3mm (Crimping Single row)**

Maximum contact number : **32 contacts (Crimping Double row)**

3. Board Pre-fixed Mechanism

The insertion state to the board is a light crimping, which enables the pre-fixed process to the board.

■ Applications

Note PC, Small business equipment

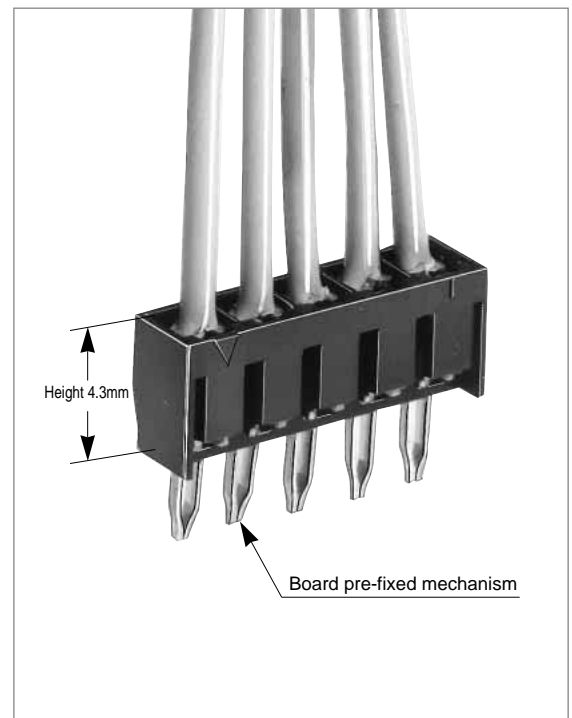

Product Specifications

Rating	Current rating (Note 1)	Crimping	Cable Size	AWG 24 : 3A AWG 26 : 2A AWG 28 : 1A	Operating Temperature Range	-30 to +85°C(Note 1)
	Voltage rating	Crimping		250V AC	Operating Moisture Range	40 to 80%
					Storage Temperature Range	-10 to +60°C(Note 2)
					Storage Moisture Range	40 to 70%

Item	Specification	Condition
1. Insulation Resistance	1000M ohms Min	500V DC
2. Withstanding voltage	No flashover or insulation breakdown.	650V AC/1 minute
3. Crimping Area Resistance	30m ohms Max.	100mA
4. Vibration	No damage, cracks, or parts looseness.	Frequency: 10 to 55 Hz, single amplitude of 0.75 mm, 2 hours in each of the 3 directions.
5. Humidity (Steady state)	Contact resistance: 30m ohms Max Insulation resistance: 500M ohms Min	96 hours at temperature of 40°C and humidity of 90% to 95%
6. Temperature Cycle	Contact resistance: 30m ohms Max Insulation resistance: 1000M ohms Min	Temperature -55 → 5 to 35 → +85 → -5 to 35°C time 30 → 5 to 15 → 30 → 5 to 15 min under 5 cycles.
7. Resistance to Soldering heat	No deformation of components affecting performance.	Manual soldering: 300°C for 3 seconds Flow: 250°C for 10 seconds

Note 1: The rated current will be changed according to cable sizes for use.

Note 2: Includes temperature rise caused by current flow.

Note 3: The term "storage" refers to products stored for long period of time prior to mounting and use. Operating Temperature Range and Humidity range covers non conducting condition of installed connectors in storage, shipment or during transportation.

Note 4: Information contained in this catalog represents general requirements for this Series. Contact us for the drawings and specifications for a specific part number shown.

Material

Product	Part	Material	Finish	Remarks
Crimping Plug	Insulator	Polyamide	Black	UL94V-0
Crimping Contact for Plug	Contact	Brass	Tin plating	———

Ordering Information

Connector

DF4 - * **P** - **2** **C**

① ② ③ ④ ⑤

① Series Name: DF4	④ Contact Pitch: 2mm
② Number of Contact: 2 to 15, 4 to 32	⑤ Connection Type
③ Connector Type P: Single row plug DP: Double row plug	C: Crimping socket

Contact

DF4 - **2428-** **PCF**

① ②

① Applicable cable size 2428 : AWG24 to 28	② Packaging Type PCF: Plug contact/Reel PC: Plug contact/Bag
---	--

■Single Row Crimping Plug

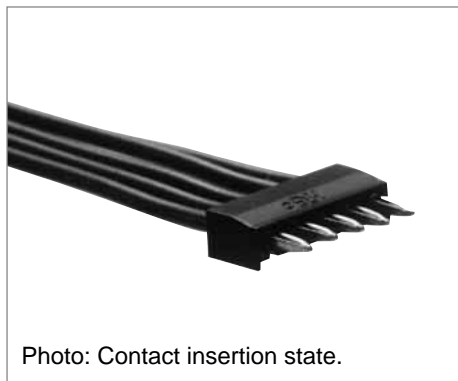

●Applicable Through-hole Diameter : $\phi 0.8 \pm 0.1$

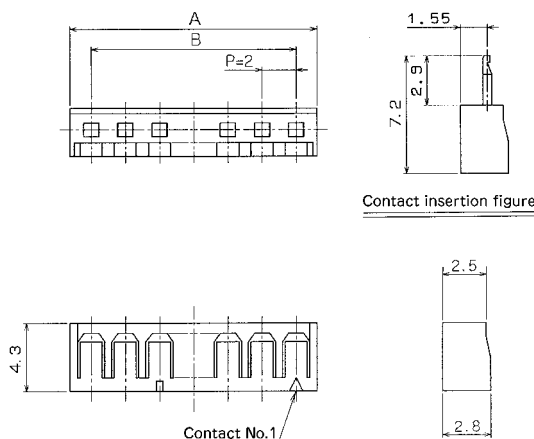

Contact insertion figure

Unit:mm

Part Number	CL No.	Number of Contacts	A	B	RoHS	Part Number	CL No.	Number of Contacts	A	B	RoHS
DF4- 2P-2C	544-0003-4	2	4.5	2.0	Yes	DF4- 9P-2C	544-0010-0	9	18.5	16.0	Yes
DF4- 3P-2C	544-0004-7	3	6.5	4.0		DF4-10P-2C	544-0011-2	10	20.5	18.0	
DF4- 4P-2C	544-0005-0	4	8.5	6.0		DF4-11P-2C	544-0012-5	11	22.5	20.0	
DF4- 5P-2C	544-0006-2	5	10.5	8.0		DF4-12P-2C	544-0013-8	12	24.5	22.0	
DF4- 6P-2C	544-0007-5	6	12.5	10.0		DF4-13P-2C	544-0014-0	13	26.5	24.0	
DF4- 7P-2C	544-0008-8	7	14.5	12.0		DF4-14P-2C	544-0015-3	14	28.5	26.0	
DF4- 8P-2C	544-0009-0	8	16.5	14.0		DF4-15P-2C	544-0016-6	15	30.5	28.0	

Note 1.The quantity at the specific No. "None" is delivered per bag (100pcs.). If needed, please order the products per bag.

■Crimping Contact

Part Number	CL No.	Packaging Type	Quantity	Finish	RoHS
DF4-2428PCF(05)	544-0020-3-05	Reel	10,000	Tin plating	Yes
DF4-2428PC(05)	544-0021-6-05	Bag	100	Tin plating	

●Applicable Cable (Tin plating Annealed copper wire)

Conductor Size	Recommended Cable	Jacket Diameter
AWG24 (11 cores./0.16mm)	UL1061	$\phi 0.75$ to $\phi 1.2$ mm
AWG 26 (7cores./0.16mm)		
AWG 28 (7cores./0.127mm)	UL1061/1007	

Note:If other cables are used instead of the applicable cable, contact Hirose sales department.

● Strip Length: 1.3 to 1.9mm

◆Applicable Crimping Tool

Type	Part Number	CL No.	Applicable Contact
Applicator	AP105-DF4-2428P	901-4539-0	DF4-2428PCF(05)
Press Main Unit	CM-105	901-0005-4	—————
Manual Crimping Tool	DF4-TA2428HC	550-0173-6	DF4-2428PC(05)
Extraction Tool	DF-C-PO (B)	550-0179-2	DF4-2428PCF(05)

Note: If any trouble has occurred due to other tools, which are not designated by Hirose, Hirose won't guarantee any products.

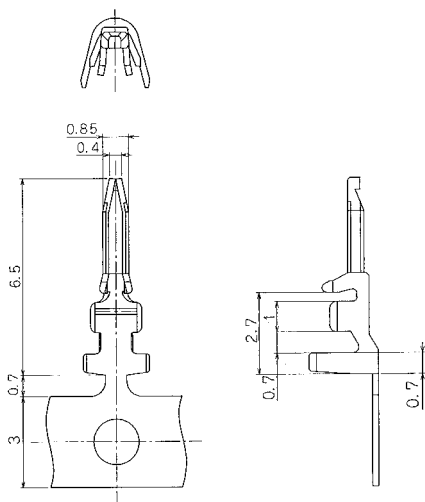

Double Row Crimping Plug

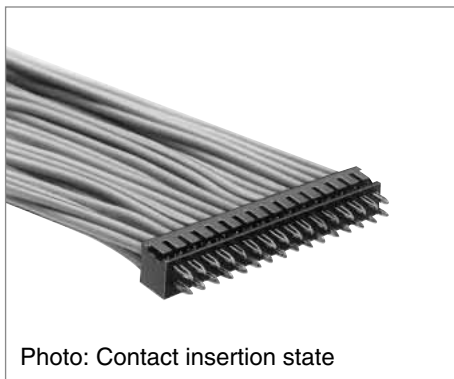

● Applicable Through-hole Diameter $\phi 0.9 \pm 0.05$

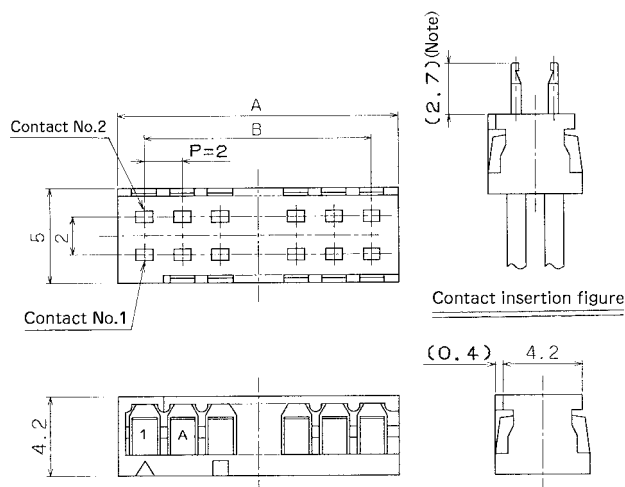

Note: The dip side may be deviated according to the cable thickness and the crimping contact bent up/down.

Unit:mm

Part Number	CL No.	Number of Contacts	A	B	RoHS
DF4- 4DP-2C	544-0078-3	4	4.8	2.0	YES
DF4- 6DP-2C	544-0079-6	6	6.8	4.0	
DF4- 8DP-2C	544-0080-5	8	8.8	6.0	
DF4-10DP-2C	544-0081-8	10	10.8	8.0	
DF4-12DP-2C	544-0082-0	12	12.8	10.0	
DF4-14DP-2C	544-0083-3	14	14.8	12.0	
DF4-16DP-2C	544-0084-6	16	16.8	14.0	
DF4-18DP-2C	544-0085-9	18	18.8	16.0	
DF4-20DP-2C	544-0086-1	20	20.8	18.0	
DF4-22DP-2C	544-0087-4	22	22.8	20.0	
DF4-24DP-2C	544-0088-7	24	24.8	22.0	
DF4-26DP-2C	544-0089-0	26	26.8	24.0	
DF4-28DP-2C	544-0090-9	28	28.8	26.0	
DF4-30DP-2C	544-0091-1	30	30.8	28.0	
DF4-32DP-2C	544-0092-4	32	32.8	30.0	

Note 1. The quantity at the specific No. "None" is delivered per bag (100pcs.). If needed, please order the products per bag.

◆ Precautions

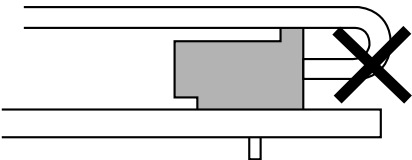
<p>1. Recommended Soldering Condition</p>	<p>Flow: 250°C for 3 seconds Manual soldering: 290±10°C for 2 seconds</p> <p>■ If the cable neighboring the connector is bent and unstraightened, secure a large bending radius because the Jacket will be broken by the solder heat and the contact wire will be exposed. The Jacket in this part will be tore.</p>  <p>■ After the soldering process. If a stress is applied to the cable in the state where the connector and the cable has heat inside, the Jacket hold area will be loosen. Therefore, carry out the post-soldering operation after the connector has returned to the room temperature..</p>
<p>2. Cleaning Condition</p>	<p>Refer to Nylon Connector Use Hand book. Don't use a solvent such as trichloroethylene which invades the cable Jacket. In addition, avoid heat cleaning by a solvent.</p>
<p>3. Connection Condition</p>	<p>Refer to the Nylon Connector Use Hand book.</p>