

0.3 mm pitch, 0.9 mm height, back flip type dual-sided FPC connector

FH35C Series

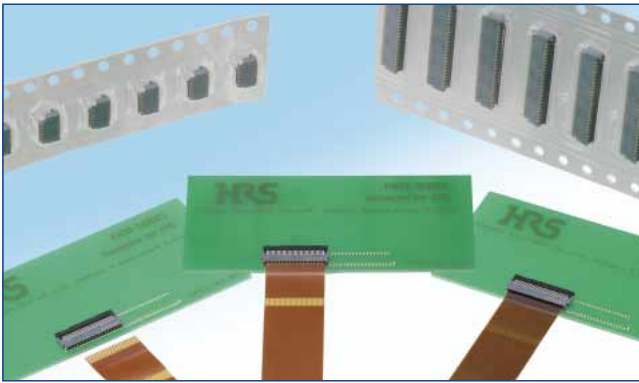

●3.2 mm in depth

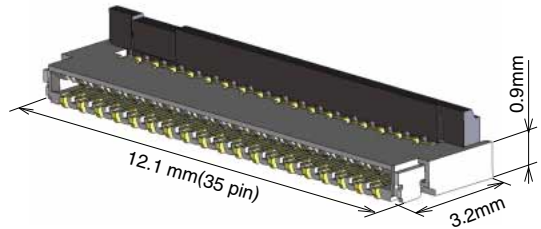

■Features

1.0.3 mm pitch, Dual-sided connector

This connector utilizes both a top and bottom contact and provides design flexibility.

2.Improved FPC retention force achieved through the use of our proprietary contact structure and a back flip actuator.

FPC retention force (in the horizontal direction) is about 2.5 times greater than similar products produced by other companies.

3.Supports high speed transmissions

By utilizing its excellent impedance characteristics, it is capable of supporting high speed transmissions. (Differential pairs of identical contacts allows for better transmission characteristics and eDP (ver1.3) and compatibility to MIPI(D-PHY) specifications.)

4.Delivered with actuator open

To reduce installation time and costs, the actuator is delivered in the open position and eliminates the need to open the actuator before FPC insertion.

5.Easy FPC Insertion

Equipped with tapered guides at the FPC insertions point, they help to create a smoother FPC insertion operation.

6.Compatible with 0.2mm thick FPC

The FH35C was designed to be used with 0.2 mm FPC. (Using the appropriate FPC will prevent deformation and problems that may occur during the insertion and mating processes.)

7.Bottom side protection

The bottom surface is over-molded and provides added protection to the contacts (no exposure). This allows the PCB space under the connector to be used for additional patterning.

8.Halogen Free

Chlorine and bromine levels do not exceed the standard values as defined by IEC 61249-2-21. (Br: 900 ppm or less, Cl : 900 ppm or less, Br + Cl : 1,500 ppm or less)

9.Compatible with Automatic Mounting

Tape-and-reel packaging is available for use with pick-and-place machines. Connectors are available on 5000 or 500 piece reels. (The outer diameter of an embossed reel is ϕ 180mm)

●At Time of FPC Insertion

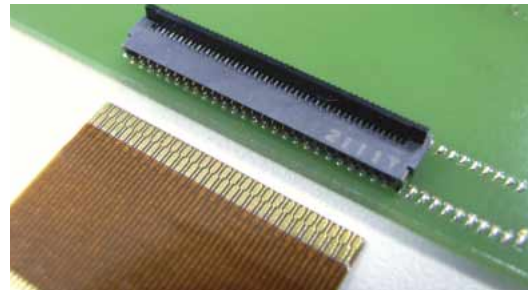

●Lock Completion State

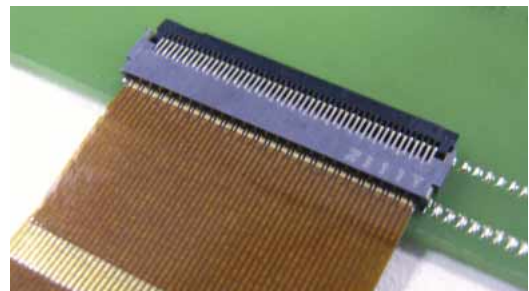

FH35C Differential Impedance

130ps rise time (20-80%)

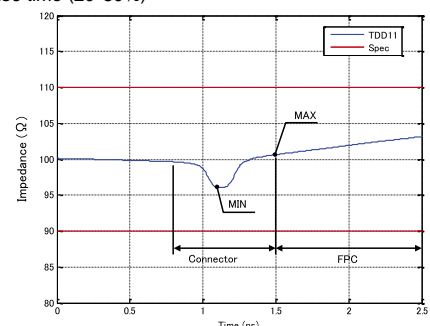

Product Specifications

| | | | |
|---------|--|---|---|
| Ratings | Current rating: 0.2 A (Note 1) Voltage rating: AC 30 Vrms | Operating temperature Range: -55 to +85°C (Note 2) Operating temperature Range: 90% or less of relative humidity (No dew condensation is allowed) | Storage temperature Range: -10 to +50°C (Note 3) Storage temperature Range: 90% or less of relative humidity (No dew condensation is allowed) |
|---------|--|---|---|

With specifications compatible with FPC contacts t = 0.2 ± 0.03 gold plating

| Items | Specifications | Conditions |
|---------------------------------------|--|---|
| 1. Insulation Resistance | No less than 50 MΩ | Measured at 100 V DC |
| 2. Withstand Voltage | No flashover or breakdown | Conduct 90 V AC for one minute |
| 3. Contact Resistance | 100 mΩ MAX. * Including FPC conductor resistance | AC 20 mV MAX (1 KHz), 1 mA |
| 4. Mating Cycles | Contact resistance: no more than 100 mΩ No breakage, cracks, or loosened parts | 10 times |
| 5. Vibration Resistance | No electric outage of 1 μs or greater Contact resistance: no more than 100 mΩ No breakage, cracks, or loosened parts | At the frequency of 10-55 Hz, half amplitude 0.75 mm, and 10 cycles in each of three axial directions |
| 6. Shock Resistance | No electric outage of 1 μs or greater Contact resistance: no more than 100 mΩ No breakage, cracks, or loosened parts | Acceleration: 981 m/s ² Duration: 6 ms, sine half-wave, 3 cycles in each of the 3 axis each in both directions |
| 7. Humidity Resistance (Steady State) | Contact resistance: no more than 100 mΩ Insulation Resistance: 50 MΩ or more No breakage, cracks, or loosened parts | Left to stand for 96 hours at the temperature of 40°C and the humidity of 90% to 95% |
| 8. Temperature Cycles | Contact resistance: no more than 100 mΩ Insulation Resistance: 50 MΩ or more No breakage, cracks, or loosened parts | Temperature: -55 → +15 to +35 → +85 → +15 to +35°C Time: 30 → 2 to 3 → 30 → 2 to 3 minutes 5 cycles with the above conditions |
| 9. Solder Heat Resistance | No deformation in appearance or marked instability of contacts | Reflow: According to the Recommended Temperature Profile Manual soldering: 350 ± 10°C for 5 ± 1 sec. |

(Note 1) Use at 70% of the current rating when all pins are energized with the stated current rating.

(Note 2) Temperature rise at the time of electrification is included.

(Note 3) The term "storage" refers to the long-term storage condition of unused products before mounting on the PCB.

The operating temperature and humidity ranges apply to non-energized state after PCB mounting.

(Note 4) The above specifications are representative of this series. Please refer to "drawing for approval" for official individual agreement.

Materials

| Part | Materials | Treatment | UL Regulation |
|---------------|-----------------|-----------------------------|---------------|
| Insulator | LCP | Gray | UL94V-0 |
| | Polyamide resin | Black | |
| Contact | Phosphor bronze | Nickel barrier Gold plating | — |
| Metal fitting | Phosphor bronze | Pure tin reflow plating | |

Product Number Structure

Refer to the chart below when searching for the part number nomenclature.

Please select connectors listed in this catalog when placing orders.

The characteristics and specifications of the products described in this catalog are for reference only.

Please make sure to check the latest delivery specifications before the time of purchase.

FH **35** **C** - **35S** - **0.3** **SHW** **(50)**

① ② ③ ④ ⑤ ⑥ ⑦

| | |
|---------------------------------------|---|
| ① Series Name: FH | ⑥ Contact Form SHW: SMT horizontal staggered array mount type |
| ② Series No.: 35 | |
| ③ C: dual-sided, halogen-free product | ⑦ Specifications: (50): standard product (5000 connectors per reel) (99): 500 connectors per reel |
| ④ Number of contacts : 9 to 51 | |
| ⑤ Contact Pitch: 0.3 mm | |

Connector Dimensions

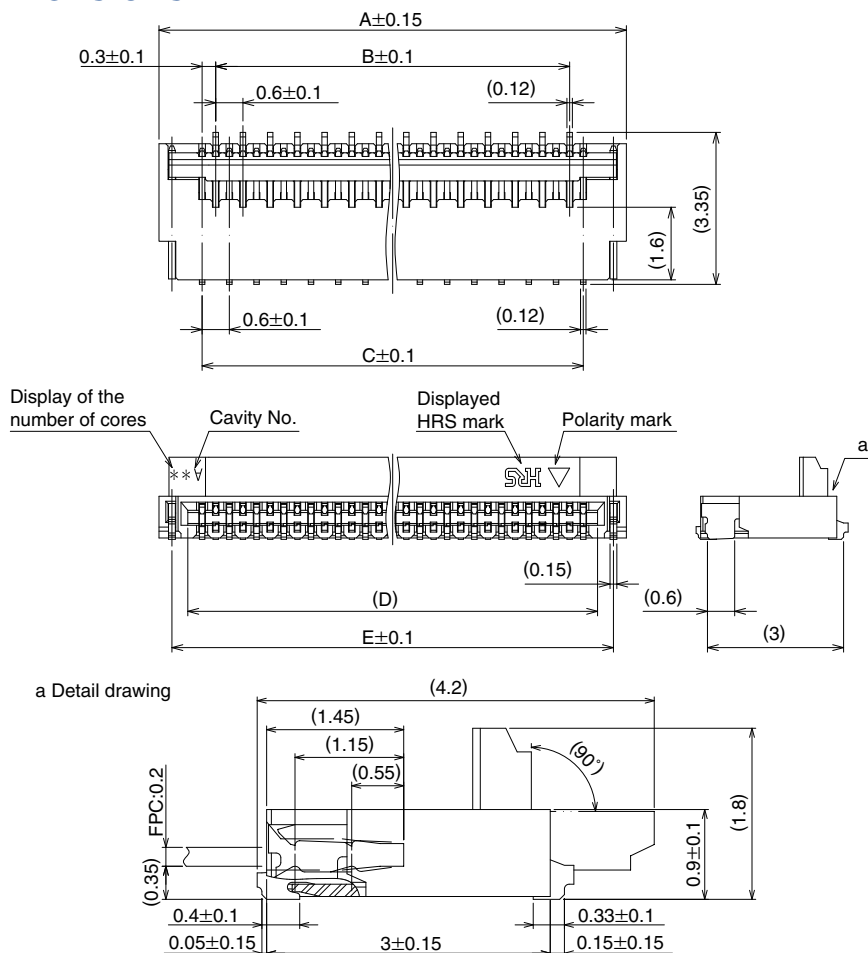

- Note 1: The lead coplanarity of contact and reinforcing metal fitting is a MAX of 0.1 mm.
 Note 2: This product packaged on tape-and-reel. See the package specification diagram for details.
 Note 3: Dimensions may be changed for sink mark prevention due to improvement, etc.
 In addition, black dots, etc., may occur in the mold resin but they have no effect on quality.
 Note 4: This product is halogen-free.
 (Br content: 900 ppm or less; Cl content: 900 ppm or less; Br + CL total content: 1,500 ppm or less)

Connector Dimension Table

Unit: mm

| Product No. | HRS No. | The number of contacts | A | B | C | D | E |
|----------------------|-----------------|------------------------|------|------|------|-------|-------|
| FH35C-9S-0.3SHW(50) | CL580-2910-5-50 | 9 | 4.3 | 1.8 | 2.4 | 3.03 | 3.73 |
| FH35C-11S-0.3SHW(50) | CL580-2917-4-50 | 11 | 4.9 | 2.4 | 3 | 3.63 | 4.33 |
| FH35C-13S-0.3SHW(50) | CL580-2925-2-50 | 13 | 5.5 | 3 | 3.6 | 4.23 | 4.93 |
| FH35C-15S-0.3SHW(50) | CL580-2919-0-50 | 15 | 6.1 | 3.6 | 4.2 | 4.83 | 5.53 |
| FH35C-17S-0.3SHW(50) | CL580-2916-1-50 | 17 | 6.7 | 4.2 | 4.8 | 5.43 | 6.13 |
| FH35C-19S-0.3SHW(50) | CL580-2921-1-50 | 19 | 7.3 | 4.8 | 5.4 | 6.03 | 6.73 |
| FH35C-21S-0.3SHW(50) | CL580-2922-4-50 | 21 | 7.9 | 5.4 | 6 | 6.63 | 7.33 |
| FH35C-23S-0.3SHW(50) | CL580-2911-8-50 | 23 | 8.5 | 6 | 6.6 | 7.23 | 7.93 |
| FH35C-25S-0.3SHW(50) | CL580-2912-0-50 | 25 | 9.1 | 6.6 | 7.2 | 7.83 | 8.53 |
| FH35C-27S-0.3SHW(50) | CL580-2918-7-50 | 27 | 9.7 | 7.2 | 7.8 | 8.43 | 9.13 |
| FH35C-31S-0.3SHW(50) | CL580-2923-7-50 | 31 | 10.9 | 8.4 | 9 | 9.63 | 10.33 |
| FH35C-33S-0.3SHW(50) | CL580-2913-3-50 | 33 | 11.5 | 9 | 9.6 | 10.23 | 10.93 |
| FH35C-35S-0.3SHW(50) | CL580-2926-5-50 | 35 | 12.1 | 9.6 | 10.2 | 10.83 | 11.53 |
| FH35C-37S-0.3SHW(50) | CL580-2914-6-50 | 37 | 12.7 | 10.2 | 10.8 | 11.43 | 12.13 |
| FH35C-39S-0.3SHW(50) | CL580-2915-9-50 | 39 | 13.3 | 10.8 | 11.4 | 12.03 | 12.73 |
| FH35C-41S-0.3SHW(50) | CL580-2924-0-50 | 41 | 13.9 | 11.4 | 12 | 12.63 | 13.33 |
| FH35C-45S-0.3SHW(50) | CL580-2909-6-50 | 45 | 15.1 | 12.6 | 13.2 | 13.83 | 14.53 |
| FH35C-49S-0.3SHW(50) | — | 49 | 16.3 | 13.8 | 14.4 | 15.03 | 15.73 |
| FH35C-51S-0.3SHW(50) | CL580-2920-9-50 | 51 | 16.9 | 14.4 | 15 | 15.63 | 16.33 |

The products with no HRS No. are currently under planning. Please contact our sales representative for questions concerning the number of contacts.

Recommended Land Dimensions

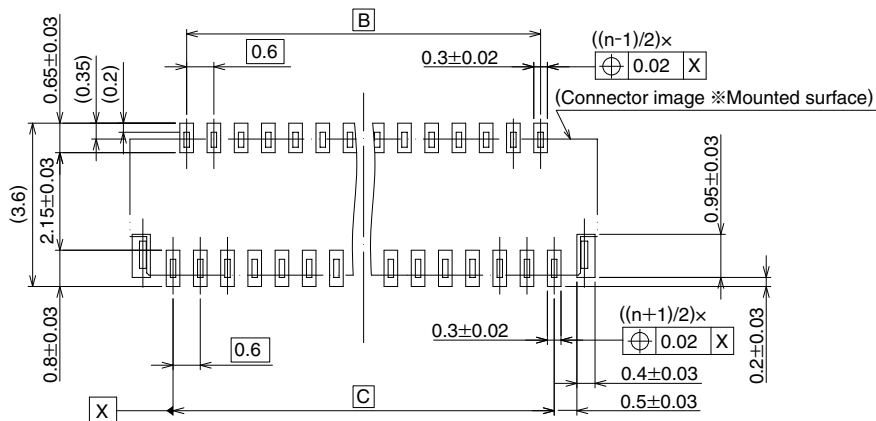

Recommended Land and Metal Mask Dimensions

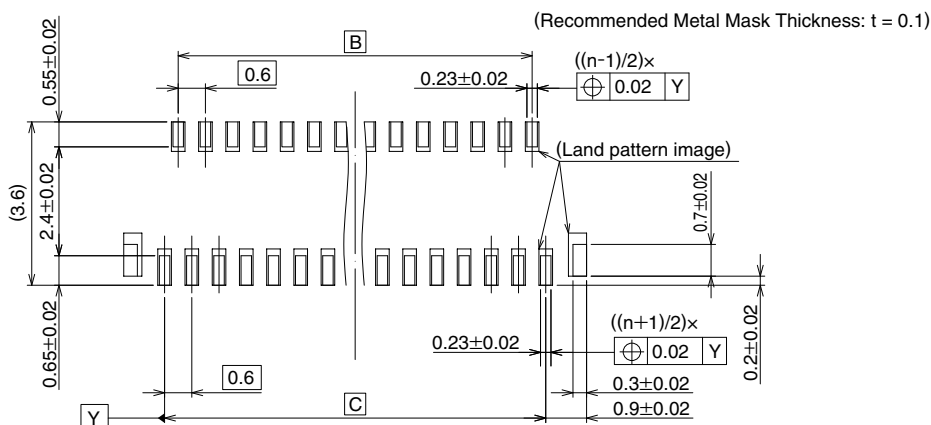

Note 5: 'n' represents the number of contacts.

Recommended Land and Metal Mask Dimensions

Unit: mm

| Product No. | HRS No. | No. of Contacts | B | C |
|----------------------|-----------------|-----------------|------|------|
| FH35C-9S-0.3SHW(50) | CL580-2910-5-50 | 9 | 1.8 | 2.4 |
| FH35C-11S-0.3SHW(50) | CL580-2917-4-50 | 11 | 2.4 | 3 |
| FH35C-13S-0.3SHW(50) | CL580-2925-2-50 | 13 | 3 | 3.6 |
| FH35C-15S-0.3SHW(50) | CL580-2919-0-50 | 15 | 3.6 | 4.2 |
| FH35C-17S-0.3SHW(50) | CL580-2916-1-50 | 17 | 4.2 | 4.8 |
| FH35C-19S-0.3SHW(50) | CL580-2921-1-50 | 19 | 4.8 | 5.4 |
| FH35C-21S-0.3SHW(50) | CL580-2922-4-50 | 21 | 5.4 | 6 |
| FH35C-23S-0.3SHW(50) | CL580-2911-8-50 | 23 | 6 | 6.6 |
| FH35C-25S-0.3SHW(50) | CL580-2912-0-50 | 25 | 6.6 | 7.2 |
| FH35C-27S-0.3SHW(50) | CL580-2918-7-50 | 27 | 7.2 | 7.8 |
| FH35C-31S-0.3SHW(50) | CL580-2923-7-50 | 31 | 8.4 | 9 |
| FH35C-33S-0.3SHW(50) | CL580-2913-3-50 | 33 | 9 | 9.6 |
| FH35C-35S-0.3SHW(50) | CL580-2926-5-50 | 35 | 9.6 | 10.2 |
| FH35C-37S-0.3SHW(50) | CL580-2914-6-50 | 37 | 10.2 | 10.8 |
| FH35C-39S-0.3SHW(50) | CL580-2915-9-50 | 39 | 10.8 | 11.4 |
| FH35C-41S-0.3SHW(50) | CL580-2924-0-50 | 41 | 11.4 | 12 |
| FH35C-45S-0.3SHW(50) | CL580-2909-6-50 | 45 | 12.6 | 13.2 |
| FH35C-49S-0.3SHW(50) | ————— | 49 | 13.8 | 14.4 |
| FH35C-51S-0.3SHW(50) | CL580-2920-9-50 | 51 | 14.4 | 15 |

Recommended FPC Dimensions

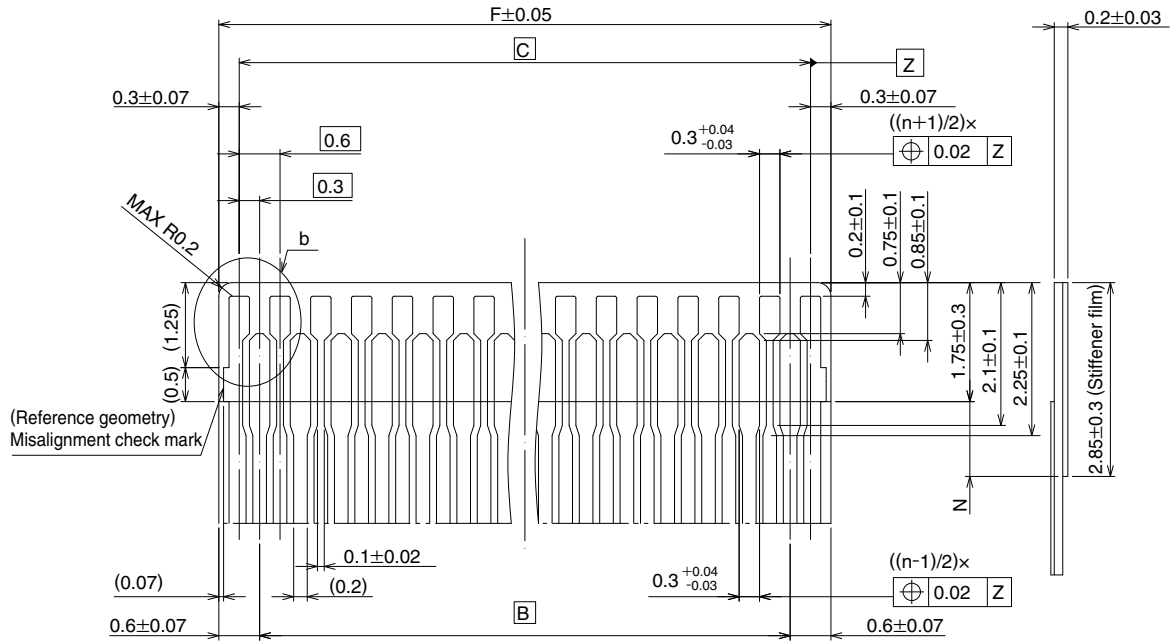

Note 6: FPC should be designed so that the dimension of N is 0.5 mm or more.

Recommended FPC Dimensions

Unit: mm

| Product No. | HRS No. | No. of Contacts | B | C | F |
|----------------------|-----------------|-----------------|------|------|------|
| FH35C-9S-0.3SHW(50) | CL580-2910-5-50 | 9 | 1.8 | 2.4 | 3 |
| FH35C-11S-0.3SHW(50) | CL580-2917-4-50 | 11 | 2.4 | 3 | 3.6 |
| FH35C-13S-0.3SHW(50) | CL580-2925-2-50 | 13 | 3 | 3.6 | 4.2 |
| FH35C-15S-0.3SHW(50) | CL580-2919-0-50 | 15 | 3.6 | 4.2 | 4.8 |
| FH35C-17S-0.3SHW(50) | CL580-2916-1-50 | 17 | 4.2 | 4.8 | 5.4 |
| FH35C-19S-0.3SHW(50) | CL580-2921-1-50 | 19 | 4.8 | 5.4 | 6 |
| FH35C-21S-0.3SHW(50) | CL580-2922-4-50 | 21 | 5.4 | 6 | 6.6 |
| FH35C-23S-0.3SHW(50) | CL580-2911-8-50 | 23 | 6 | 6.6 | 7.2 |
| FH35C-25S-0.3SHW(50) | CL580-2912-0-50 | 25 | 6.6 | 7.2 | 7.8 |
| FH35C-27S-0.3SHW(50) | CL580-2918-7-50 | 27 | 7.2 | 7.8 | 8.4 |
| FH35C-31S-0.3SHW(50) | CL580-2923-7-50 | 31 | 8.4 | 9 | 9.6 |
| FH35C-33S-0.3SHW(50) | CL580-2913-3-50 | 33 | 9 | 9.6 | 10.2 |
| FH35C-35S-0.3SHW(50) | CL580-2926-5-50 | 35 | 9.6 | 10.2 | 10.8 |
| FH35C-37S-0.3SHW(50) | CL580-2914-6-50 | 37 | 10.2 | 10.8 | 11.4 |
| FH35C-39S-0.3SHW(50) | CL580-2915-9-50 | 39 | 10.8 | 11.4 | 12 |
| FH35C-41S-0.3SHW(50) | CL580-2924-0-50 | 41 | 11.4 | 12 | 12.6 |
| FH35C-45S-0.3SHW(50) | CL580-2909-6-50 | 45 | 12.6 | 13.2 | 13.8 |
| FH35C-49S-0.3SHW(50) | — | 49 | 13.8 | 14.4 | 15 |
| FH35C-51S-0.3SHW(50) | CL580-2920-9-50 | 51 | 14.4 | 15 | 15.6 |

◆ FPC material composition (Recommended specifications)

1. Single-Sided FPC

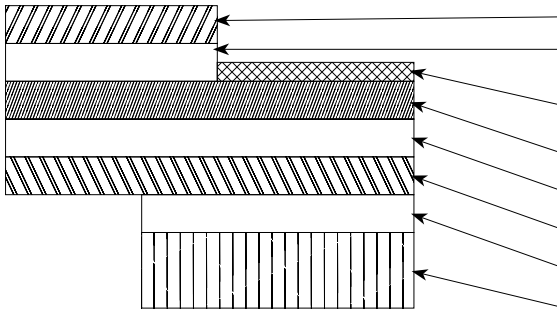

| Name of material | Material property | Thickness (μm) |
|---------------------------------|--|----------------|
| Cover lay film | Polyimide 1 mil | (25) |
| Cover adhesive | | (25) |
| Surface treatment | Nickel undercoat 1 to 5 μm+ Gold plating 0.2 μm | 3 |
| Copper foil | Cu 1 oz | 35 |
| Base adhesive | Heat hardened adhesive | 25 |
| Base film | Polyimide 1 mil | 25 |
| Reinforcement material adhesive | Heat hardened adhesive | 40 |
| Stiffener film | Polyimide 3 mil | 75 |
| Total | | 203 |

2. Double-Sided FPC

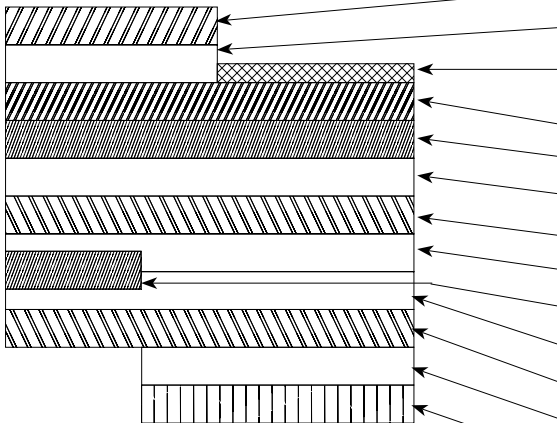

| Name of material | Material property | Thickness (μm) |
|---------------------------------|--|----------------|
| Cover lay film | Polyimide 1 mil | (25) |
| Cover adhesive | | (25) |
| Surface treatment | Nickel undercoat 1 to 5 μm+ Gold plating 0.2 μm | 3 |
| Through-hole copper plating | Cu | 15 |
| Copper foil | Cu ½ oz | 18 |
| Base adhesive | Thermoset adhesive | 18 |
| Base film | Polyimide 1 mil | 25 |
| Base adhesive | Thermoset adhesive | 18 |
| Copper foil | Cu ½ oz | (18) |
| Cover adhesive | Thermoset adhesive | 25 |
| Cover lay film | Polyimide 1 mil | 25 |
| Reinforcement material adhesive | Thermoset adhesive | 25 |
| Stiffener film | Polyimide 1 mil | 25 |
| Total | | 197 |

*When using Double-Sided FPC, the copper foil on the back side of the FPC should be eliminated. This is to prevent any unintentional unlocking due to bent or deformed FPC.

3. Additional notes on FPC

1. The FPC material composition is to be used as a reference example. Please make sure that the thickness of the FPC mating area is 0.2 ± 0.03 mm as previously referred to in the product specification section.
2. Please contact the FPC manufacturer for the details on its material composition.

◆ Packaging Specifications

● Emboss Carrier Tape Dimensions (with tape width of 24 mm or less)

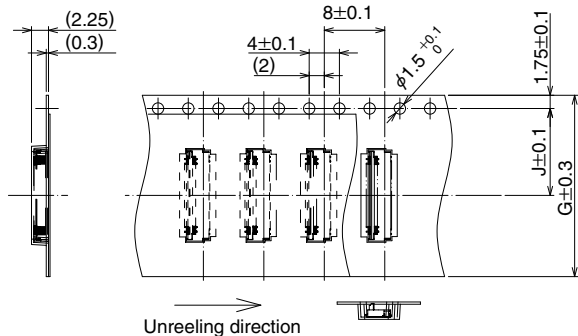

● Emboss Carrier Tape Dimensions (with tape width of 32 mm or more)

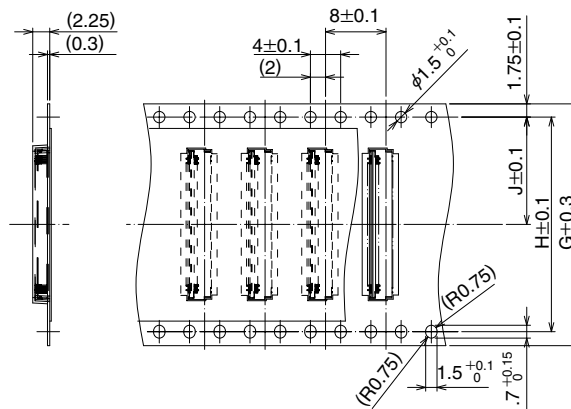

● Packaging Specification Dimensions

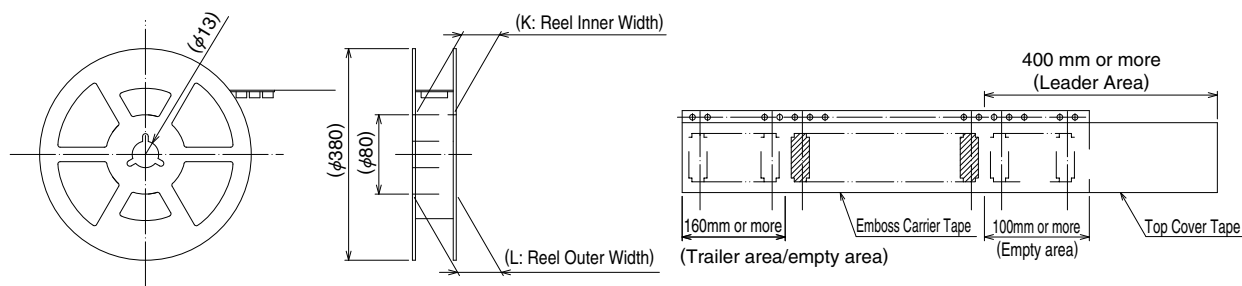

■ Reel Dimensions

Unit: mm

| Product No. | HRS No. | No. of Contacts | G | H | J | K | L |
|----------------------|-----------------|-----------------|----|------|------|------|------|
| FH35C-9S-0.3SHW(50) | CL580-2910-5-50 | 9 | 16 | - | 7.5 | 17.4 | 21.4 |
| FH35C-11S-0.3SHW(50) | CL580-2917-4-50 | 11 | 16 | - | 7.5 | 17.4 | 21.4 |
| FH35C-13S-0.3SHW(50) | CL580-2925-2-50 | 13 | 16 | - | 7.5 | 17.4 | 21.4 |
| FH35C-15S-0.3SHW(50) | CL580-2919-0-50 | 15 | 16 | - | 7.5 | 17.4 | 21.4 |
| FH35C-17S-0.3SHW(50) | CL580-2916-1-50 | 17 | 16 | - | 7.5 | 17.4 | 21.4 |
| FH35C-19S-0.3SHW(50) | CL580-2921-1-50 | 19 | 16 | - | 7.5 | 17.4 | 21.4 |
| FH35C-21S-0.3SHW(50) | CL580-2922-4-50 | 21 | 24 | - | 11.5 | 25.4 | 29.4 |
| FH35C-23S-0.3SHW(50) | CL580-2911-8-50 | 23 | 24 | - | 11.5 | 25.4 | 29.4 |
| FH35C-25S-0.3SHW(50) | CL580-2912-0-50 | 25 | 24 | - | 11.5 | 25.4 | 29.4 |
| FH35C-27S-0.3SHW(50) | CL580-2918-7-50 | 27 | 24 | - | 11.5 | 25.4 | 29.4 |
| FH35C-31S-0.3SHW(50) | CL580-2923-7-50 | 31 | 24 | - | 11.5 | 25.4 | 29.4 |
| FH35C-33S-0.3SHW(50) | CL580-2913-3-50 | 33 | 24 | - | 11.5 | 25.4 | 29.4 |
| FH35C-35S-0.3SHW(50) | CL580-2926-5-50 | 35 | 24 | - | 11.5 | 25.4 | 29.4 |
| FH35C-37S-0.3SHW(50) | CL580-2914-6-50 | 37 | 24 | - | 11.5 | 25.4 | 29.4 |
| FH35C-39S-0.3SHW(50) | CL580-2915-9-50 | 39 | 24 | - | 11.5 | 25.4 | 29.4 |
| FH35C-41S-0.3SHW(50) | CL580-2924-0-50 | 41 | 24 | - | 11.5 | 25.4 | 29.4 |
| FH35C-45S-0.3SHW(50) | CL580-2909-6-50 | 45 | 24 | - | 11.5 | 25.4 | 29.4 |
| FH35C-49S-0.3SHW(50) | - | 49 | 32 | 28.4 | 14.2 | 33.4 | 37.4 |
| FH35C-51S-0.3SHW(50) | CL580-2920-9-50 | 51 | 32 | 28.4 | 14.2 | 33.4 | 37.4 |

Temperature Profile

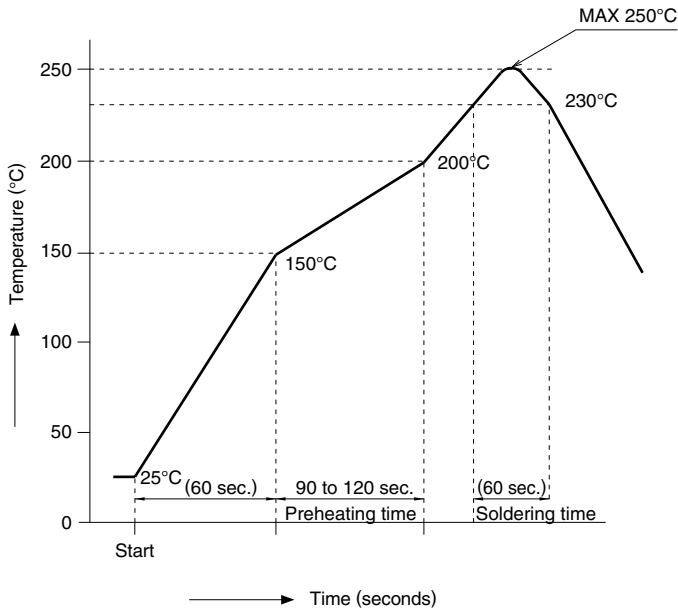

Applicable Conditions

- Reflow System : Far-infrared, hot-air reflow
- Reflow chamber atmosphere : Air
- Solder : Paste type Sn/3.0 Ag/0.5 Cu (M705-GRN360-K2-V; Senju Metal Industry Co., Ltd.)
- Test PCB : PCB material and size
Glass epoxy 25 × 50 × 0.8 mm
Land dimensions
0.3 × 0.65, 0.3 × 0.8 mm
- Metal Mask : Thickness : 0.1 mm
Opening dimension
0.23 × 0.55, 0.23 × 0.65 mm

The provided temperature profile shown is based on the conditions described above. Variations may occur due to the changing conditions such as solder paste types, different manufacturers, PCB size, and other soldering materials. Please check the mounting conditions before use.

◆ Connector Handling and Precautions

[Operational Method]

These connectors are small and thin, so care needs to be used when handling this product. Please refer to this section after confirming the following points:

1. Initial mounted status (before inserting FPC)

- These connectors are delivered with the actuator in an open position, removing the need to operate the actuator before inserting the FPC.

[Caution]

- Do not close the actuator if the FPC has not been inserted yet.
- If the actuator is closed without the FPC, it can narrow the contact gap and increases the insertion force.

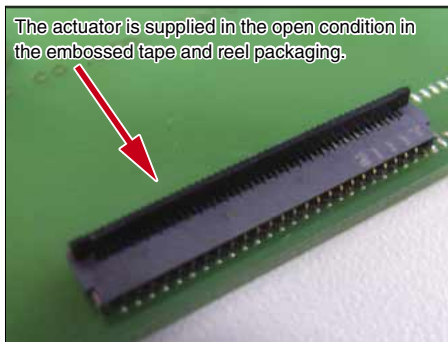

2. FPC insertion method

- Ensure that the FPC is held parallel to the surface of the PCB and is then completely inserted into the connector.

[Caution]

- Do not insert the FPC if actuator is closed.
- If the actuator is closed and if the FPC is twisted during insertion, it can cause contact deformation and / or contact failure.

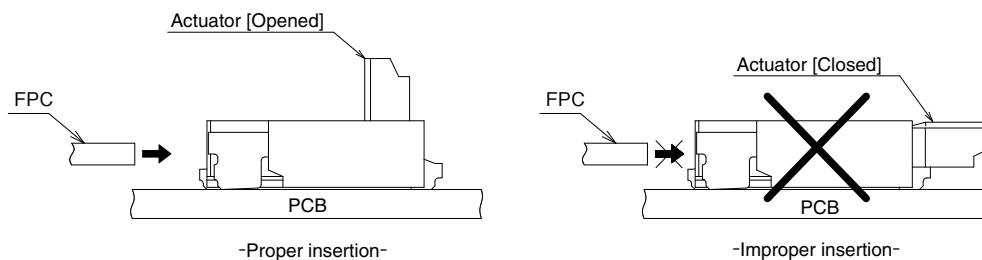

3. Confirmation of inserted FPC (when the top contact is used)

- By visually comparing the edge of the connector housing opening with the exposed FPC pattern, faulty insertion conditions such as a skewed or shallow insertion can be prevented.

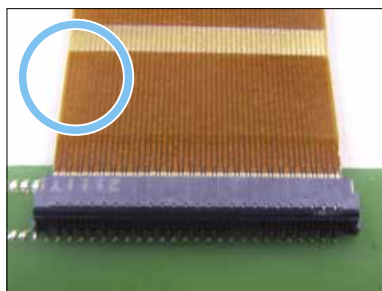
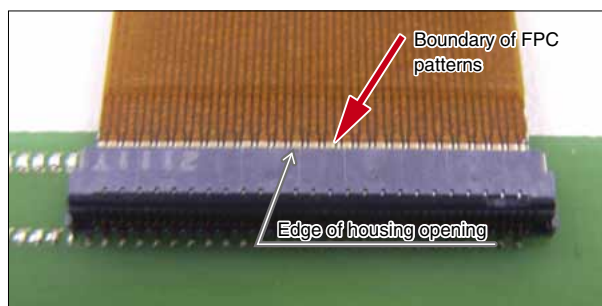

Proper insertion

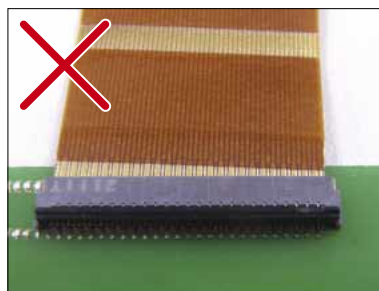

Skewed insertion

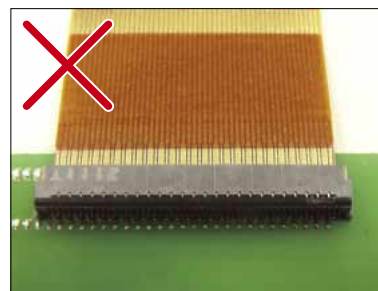

Shallow insertion

◆ Connector Handling and Precautions

[Operational Method]

4. Locking method

- Operate the actuator in a rotational manner and press it down.
Rotate and push down on the middle portion or the entire width of the actuator using the finger tip. Be sure to distribute the pressure evenly across the actuator, pressing down on only one side of the actuator may damage the actuator. Excessive force on the housing can also lead to damage or malfunction.

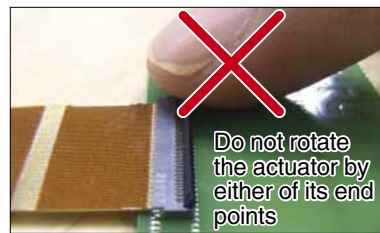
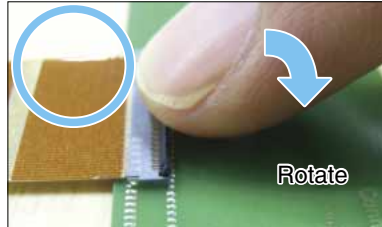

5. Removing the FPC

- Slowly rotate the actuator in an upward motion. After it is unlocked, the FPC can be removed.
- When unlocking the actuator, always touch the middle portion of the actuator.
Again, be sure to distribute the pressure evenly across the actuator, pressing down on only one side may damage the actuator. The actuator has a maximum opening of 90°. Trying to open it more than that or applying any unnecessary force to the actuator will cause damage and possibly failure of the connector.

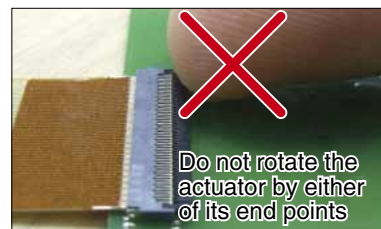
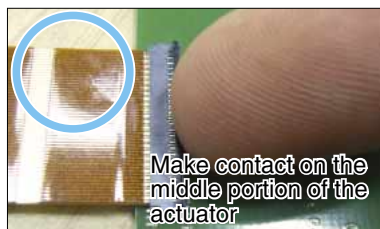
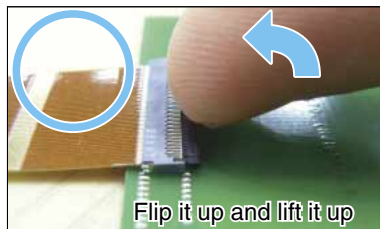

This connector uses a back flip type structure. The direction of the FPC insertion and that of the actuator are different from front flip type connectors. Do not try to open the actuator from the FPC side.

◆ Connector Handling and Precautions

[Operational Method]

6. FPC Routing

① FPC should be routed in a manner that no strain or load is exerted onto the FPC. Disregarding this note may result in unintentional disconnection or damage to the FPC, which can lead to defects such as contact failure.

Caution:

- Do not allow the FPC or stiffener to touch the casings, housings or any other items.
- When routing the FPC, make sure that no strain or load is applied to the connector in a pulling, pushing or side-to-side motion. Additionally, make sure that no excessive upward or downward force is applied to the connector.
- When routing the FPC, make sure that the routing provides a stress free path for the FPC and keep the stiffener parallel to the PCB. Observe proper bend radii.
- Do not place or mount any parts that will interfere with the FPC routing.

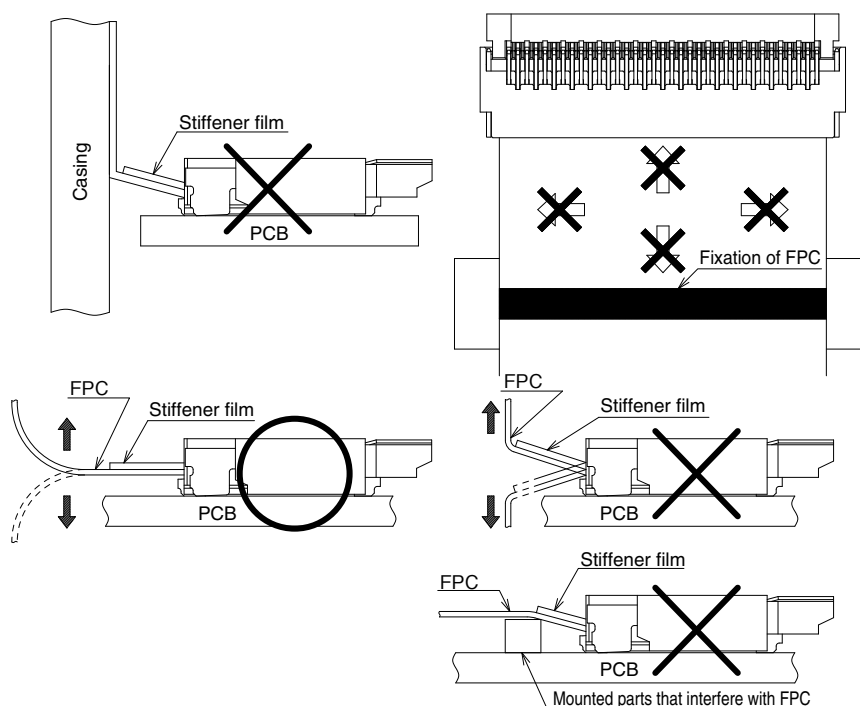

◆ Connector Handling and Precautions

[Precautions for mounting the connectors onto PCB]

◆ PCB Warpage

Minimize PCB warpage. Although the coplanarity of this connector is 0.1 mm or less, mounting problems and defects may occur when excess PCB warpage is present.

◆ Mounting onto FPC

When mounting the connector on FPC, be sure to use a reinforcing board as it will make it easier to handle and more reliable. We recommend that you use glass epoxy, 0.3 mm thickness or more.

◆ Load to Connector

Do not apply any external force of 0.5 N or more to the connector before mounting it. Excessive forces may cause the connector to break. Do not insert the FPC or operate the actuator before mounting the connector.

◆ Load to board

- Divide the base material for multiple PCBs
- Fasten the PCBs with screws

Care should be taken so that the load is not exerted on the PCBs during the assembly process when conducting operations including those previously described. Failure to adhere to these precautions may result in connector damage and ultimately failure.

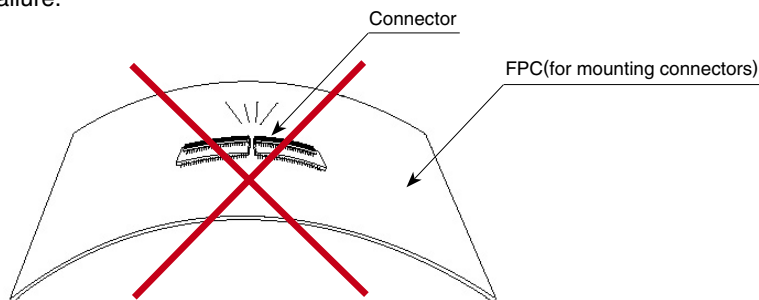

◆ Hand Soldering Precautions

When performing repairs and hand soldering is being used, please take note of the following precautions:

- ① Do not perform reflow or hand soldering while the FPC is inserted into the connector.
- ② Do not apply excessive heat to the connector and make sure that the soldering iron only makes contact with the connector lead. This precaution prevents connector deformation or melting.
- ③ Do not apply excessive amounts of solder or flux. Using excessive amounts of solder or flux on the contacts may cause the solder to wick into the contact areas or the shaft of the actuator. This can result in contact failure and/or rotational problems with the actuator.

Additionally, if excessive solder or flux is applied to the reinforcing metal fittings, problems may develop to the rotation function of the actuator and could lead to connector damage and ultimately lead to failure.



HIROSE ELECTRIC CO.,LTD.

6-3,Nakagawa Chuoh-2-Chome,Tsuzuki-Ku,Yokohama-Shi 224-8540,JAPAN
 TEL: +81-45-620-3526 Fax: +81-45-591-3726
<http://www.hirose.com>
<http://www.hirose-connectors.com>