

FH62 Series



Dimension diagram : 35 pos.

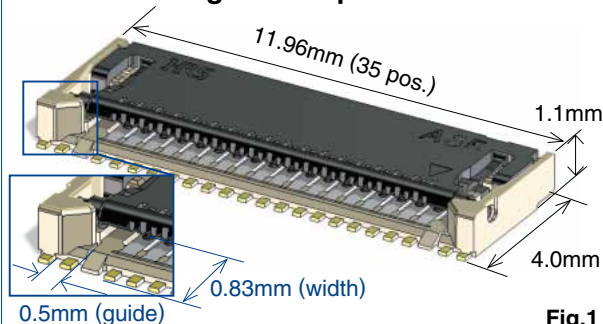

Fig.1

Features

1. Space-saving design

·Space saving design with 0.25mm pitch, 4.0mm width. (Fig.1)

2. Automatic single action lock design

- Easy to use single action lock design by simply inserting FPC after mounting. (Fig.2) (Release the lock by operating or opening the lock lever when removing FPC.)
- Operation of the lock lever is not required at the time of mating FPC. Can be operated with one hand.
- Operation of the lock lever is not required at the time of mating FPC. Contributes to assembly time reduction.
- Operation of the lock lever is not required at the time of mating FPC. Lock lever will not be damaged by operation.
- Operation of the lock lever is not required at the time of mating FPC. No lever at insertion eliminates failures due to FPC movement during locking.

3. High FPC retention force

·The notches on both sides of FPC are held by the lock lever, generating a high FPC retention force in spite of the small size. (Fig.3)

4. Easy FPC insertion

·Wide guide for easy FPC insertion easy. (Fig.1)

5. Supports 0.3mm-thick FPC

·The design accommodates a rigid 0.3mm-thick FPC, which helps to prevent deformation of the FPC upon insertion.

6. Supports high speed transmission

·Supports high speed transmission with excellent impedance properties. By making a differential pair with the same type of contacts (even number-even number of contacts, odd number-odd-number of contacts) excellent transmission characteristics are achieved, supporting eDP (ver1.4), MIPI (D-PHY) and USB3.0 standards. (Fig.4)

7. Environmental

- Halogen free
- *As defined by IEC 61249-2-21.
Br : 900ppm max, Cl : 900ppm max,
Br+Cl : 1,500ppm max

Single action lock

[Before mating]

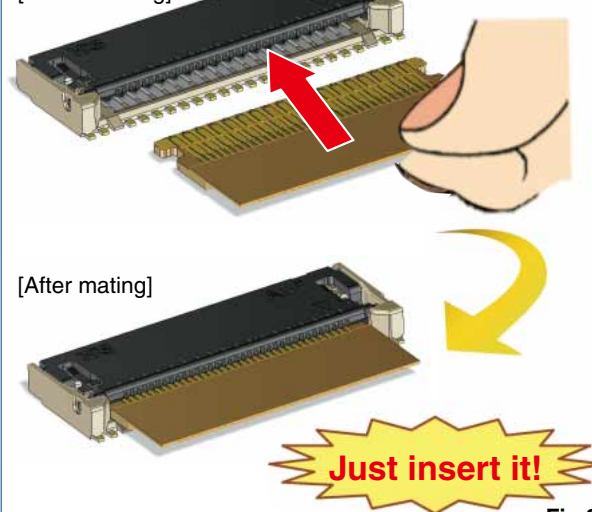

Fig.2

High FPC retention force through the lock design

[FPC being inserted]

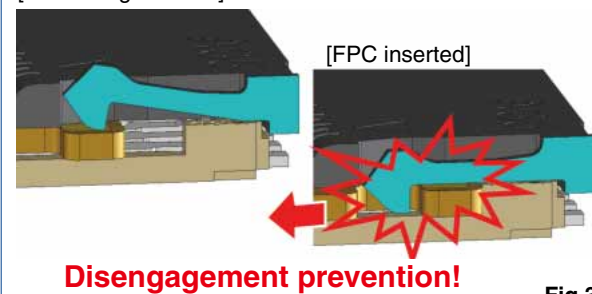

Fig.3

Supports high speed transmission (Differential impedance)

130ps rise time (20-80%)

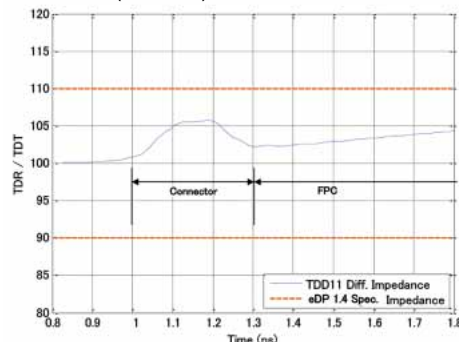

Fig.4

Product Specifications

Rating	Rated current	0.3A	Operating temperature range	-55°C to +85°C (Note 1)	Storage temperature range	-10°C to +50°C (Note 2)
	Rated voltage	30V AC/DC	Operating humidity range	Relative humidity 90% max. (No condensation)	Storage humidity range	Relative humidity 90% max. (No condensation)

Adaptive FPC/FFC contact specifications	Thickness : = 0.3±0.03mm Gold plated contact traces
---	---

Item	Specification	Conditions
1. Insulation resistance	50Ω min.	100V DC
2. Withstanding voltage	No flashover or insulation breakdown	90V AC rms / 1 minute
3. Contact resistance	100mΩ max. * Including FPC conductor resistance	1mA (AC)
4. Durability (insertion / withdrawal)	Contact resistance : 100mΩ max. No damage, cracks, or parts dislocation	10 cycles
5. Vibration	No electrical discontinuity of 1μs or more Contact resistance : 100mΩ max. No damage, cracks, or parts dislocation	Frequency : 10 to 55Hz, single amplitude of 0.75mm, 10 cycles in each of the 3 directions
6. Shock	No electrical discontinuity of 1μs or more Contact resistance : 100mΩ max. No damage, cracks, or parts dislocation	Acceleration of 981m/s ² , duration of 6ms, sine half-wave waveform, 3 cycles in each of the 3 axes
7. Humidity (Steady state)	Contact resistance : 100mΩ max. Insulation resistance : 50MΩ min. No damage, cracks, or parts dislocation	96 hours at temperature of 40°C and humidity of 90% to 95%
8. Temperature cycle	Contact resistance : 100mΩ max. Insulation resistance : 50MΩ min. No damage, cracks, or parts dislocation	Temperature : -55°C → +15°C to +35°C → +85°C → +15°C to +35°C Time : 30 → 2 to 3 → 30 → 2 to 3 (Minutes) 5 cycles
9. Resistance to soldering heat	No deformation of components affecting performance	Reflow : See recommended temperature profile (Page 8) Number of reflow : 2 times Manual soldering : 350 ± 10°C for 5 seconds

Note 1 : Includes temperature rise caused by current flow.

Note 2 : The term "storage" refers to products stored for long period of time prior to mounting and use. Operating Temperature Range and Humidity Range covers non-conducting condition of installed connectors in storage, shipment or during transportation.

Materials / Finish

Part	Material	Color / Finish	Remarks
Insulator	LCP	Beige	UL94V-0
	Polyamide	Black	
Contacts	Copper alloy	Gold plated	———

Product Number Structure

Refer to the chart below when determining the product specifications from the product number. Please select from the product numbers listed in this catalog when placing orders.

FH 62 – 35S – 0.25 SHW (10)

① ② ③ ④ ⑤ ⑥

① Series name : FH	⑤ Termination type SHW...SMT Horizontal staggered array mounting type
② Series No. : 62	
③ Number of contacts : 35	
④ Contact pitch : 0.25mm	⑥ Specifications (10) : Standard (5,000pcs/reel) (99) : 500pcs/reel

Connector Dimensions

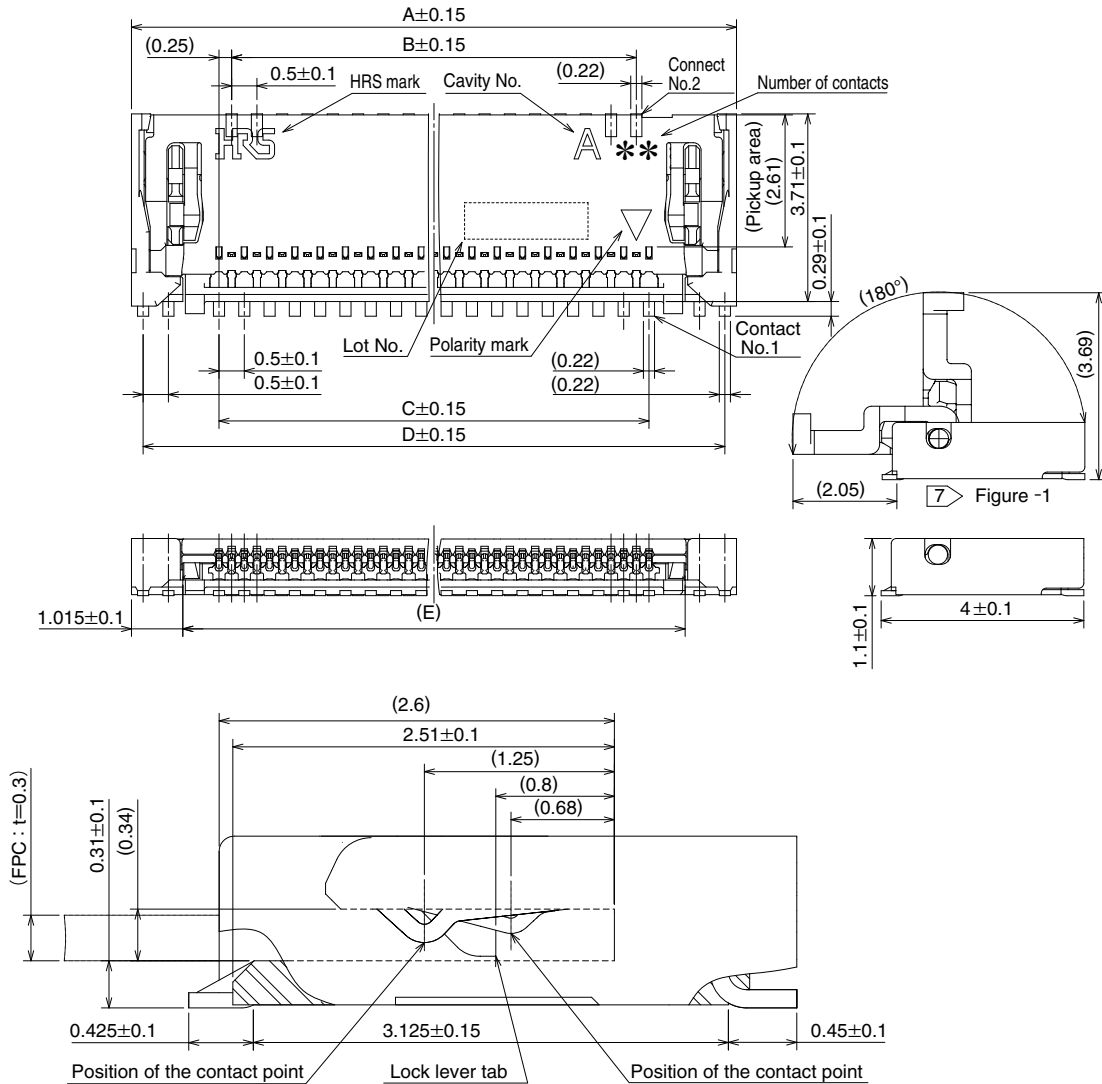

Note

- 1 : The dimension in parentheses are for reference.
- 2 : Lead co-planarity including reinforced chucking metals shall be 0.1 max.
- 3 : To be delivered with tape and reel packages.
See the packaging specifications for details.
- 4 : Note that preventive hole for sink mark or slit could be added for improvement.
- 5 : The quality remains good, even with the dark spots, which could occasionally occur on molded plastic.
- 6 : This product satisfies halogen free requirements defined as 900ppm maximum chlorine, 900ppm maximum bromine, and 1500ppm maximum total of chlorine and bromine.
- 7 > Figure-1 Shows the state of opened lock cover. FPC can be pulled out by opening the lock lever by 45 degrees or more.

Connector Dimensions

Units : mm

Part No.	HRS No.	No. of contacts	A	B	C	D	E
FH62-13S-0.25SHW(**)	580-4308-0 **	13	6.46	2.5	3	6	4.43
FH62-15S-0.25SHW(**)	Under planning (Note 1)	15	6.96	3	3.5	6.5	4.93
FH62-17S-0.25SHW(**)	580-4303-0 **	17	7.46	3.5	4	7	5.43
FH62-19S-0.25SHW(**)	Under planning (Note 1)	19	7.96	4	4.5	7.5	5.93
FH62-21S-0.25SHW(**)	580-4312-0 **	21	8.46	4.5	5	8	6.43
FH62-23S-0.25SHW(**)	Under planning (Note 1)	23	8.96	5	5.5	8.5	6.93
FH62-25S-0.25SHW(**)	Under planning (Note 1)	25	9.46	5.5	6	9	7.43
FH62-27S-0.25SHW(**)	Under planning (Note 1)	27	9.96	6	6.5	9.5	7.93
FH62-31S-0.25SHW(**)	580-4310-0 **	31	10.96	7	7.5	10.5	8.93
FH62-35S-0.25SHW(**)	580-4300-0 **	35	11.96	8	8.5	11.5	9.93
FH62-39S-0.25SHW(**)	580-4302-0 **	39	12.96	9	9.5	12.5	10.93
FH62-41S-0.25SHW(**)	580-4305-0 **	41	13.46	9.5	10	13	11.43
FH62-51S-0.25SHW(**)	Under planning (Note 1)	51	15.96	12	12.5	15.5	13.93
FH62-55S-0.25SHW(**)	580-4309-0 **	55	16.96	13	13.5	16.5	14.93
FH62-61S-0.25SHW(**)	580-4306-0 **	61	18.46	14.5	15	18	16.43

Note 1 : Contact positions without HRS No. are currently under planning.
Please contact Hirose for detailed information about product variation.

Recommended PCB Mounting Pattern

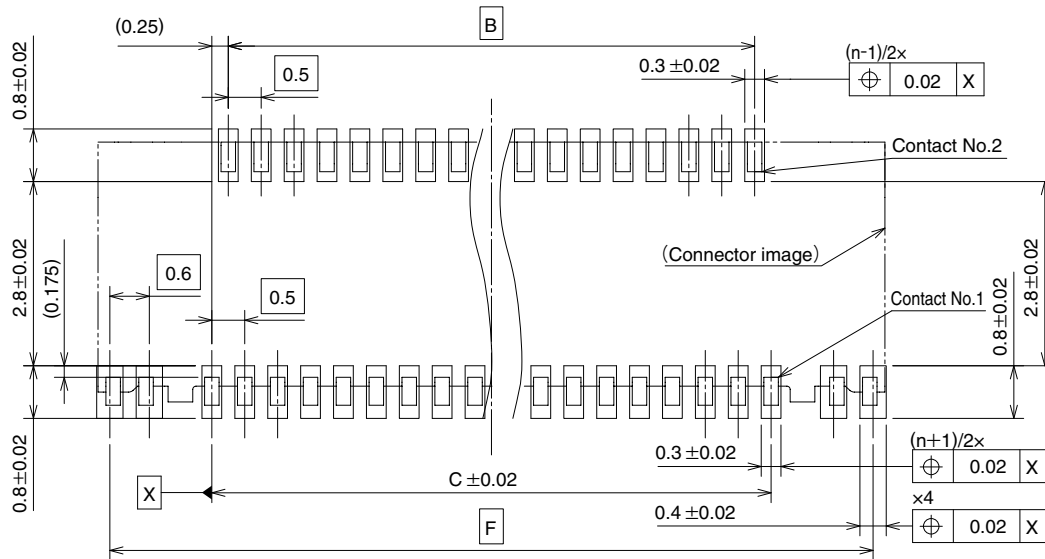

Recommended Stencil Pattern

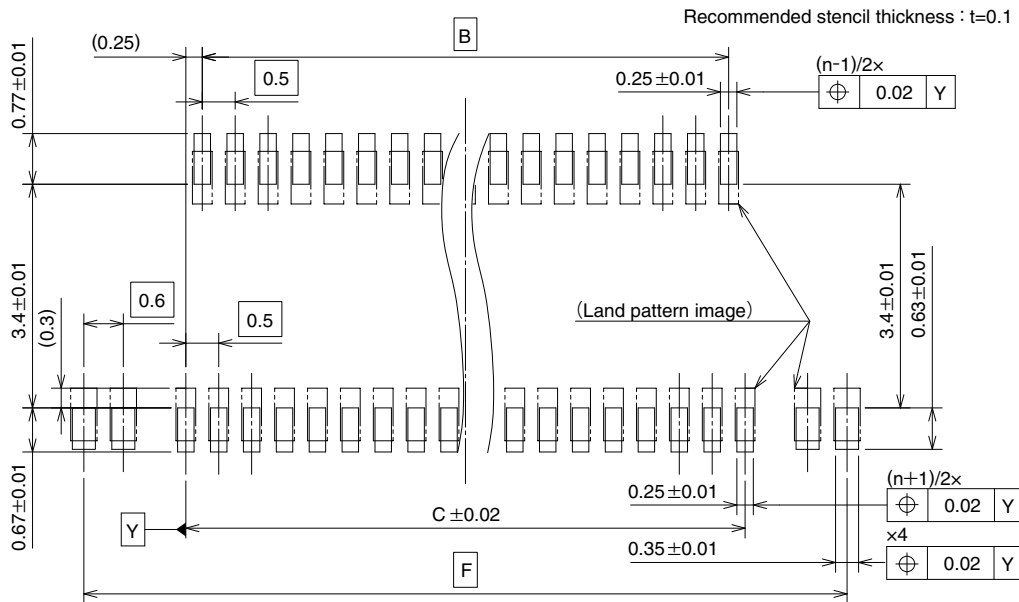

Note 8 : 'n' shows the number of contacts.

Recommended Dimensions of PCB Mounting Pattern and Stencil Pattern

Units : mm

Part No.	HRS No.	No. of contacts	B	C	F
FH62-13S-0.25SHW(**)	580-4308-0 **	13	2.5	3	6.1
FH62-15S-0.25SHW(**)	Under planning (Note 1)	15	3	3.5	6.6
FH62-17S-0.25SHW(**)	580-4303-0 **	17	3.5	4	7.1
FH62-19S-0.25SHW(**)	Under planning (Note 1)	19	4	4.5	7.6
FH62-21S-0.25SHW(**)	580-4312-0 **	21	4.5	5	8.1
FH62-23S-0.25SHW(**)	Under planning (Note 1)	23	5	5.5	8.6
FH62-25S-0.25SHW(**)	Under planning (Note 1)	25	5.5	6	9.1
FH62-27S-0.25SHW(**)	Under planning (Note 1)	27	6	6.5	9.6
FH62-31S-0.25SHW(**)	580-4310-0 **	31	7	7.5	10.6
FH62-35S-0.25SHW(**)	580-4300-0 **	35	8	8.5	11.6
FH62-39S-0.25SHW(**)	580-4302-0 **	39	9	9.5	12.6
FH62-41S-0.25SHW(**)	580-4305-0 **	41	9.5	10	13.1
FH62-51S-0.25SHW(**)	Under planning (Note 1)	51	12	12.5	15.6
FH62-55S-0.25SHW(**)	580-4309-0 **	55	13	13.5	16.6
FH62-61S-0.25SHW(**)	580-4306-0 **	61	14.5	15	18.1

Note 1 : Contact positions without HRS No. are currently under planning.
Please contact hirose for detailed information about product variation.

◆ Diagram of a recommended FPC dimension (when using plated lead part)

(FPC contact thickness : $t=0.30\pm 0.03$)

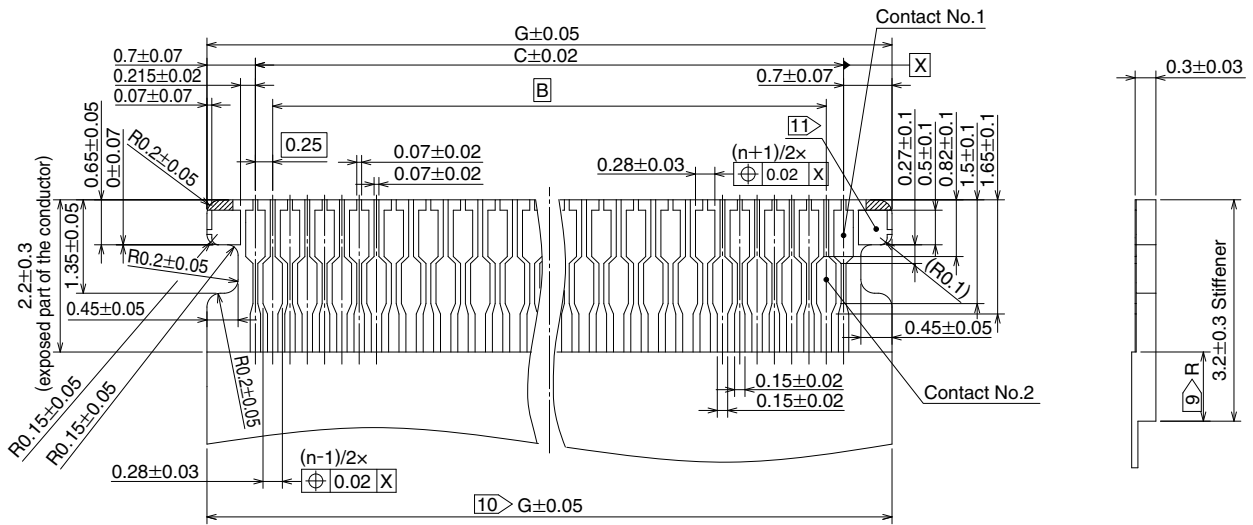

Note

- 9 Dimension R must be 0.5mm minimum.
- 10 Indicated tolerance is applicable to the exposed conductor.
- 11 Both end sides of contact pad on FPC cannot be used for signal transmission.

◆ Recommended FPC dimension (when not using plated lead part)

(FPC contact thickness : $t=0.30\pm 0.03$)

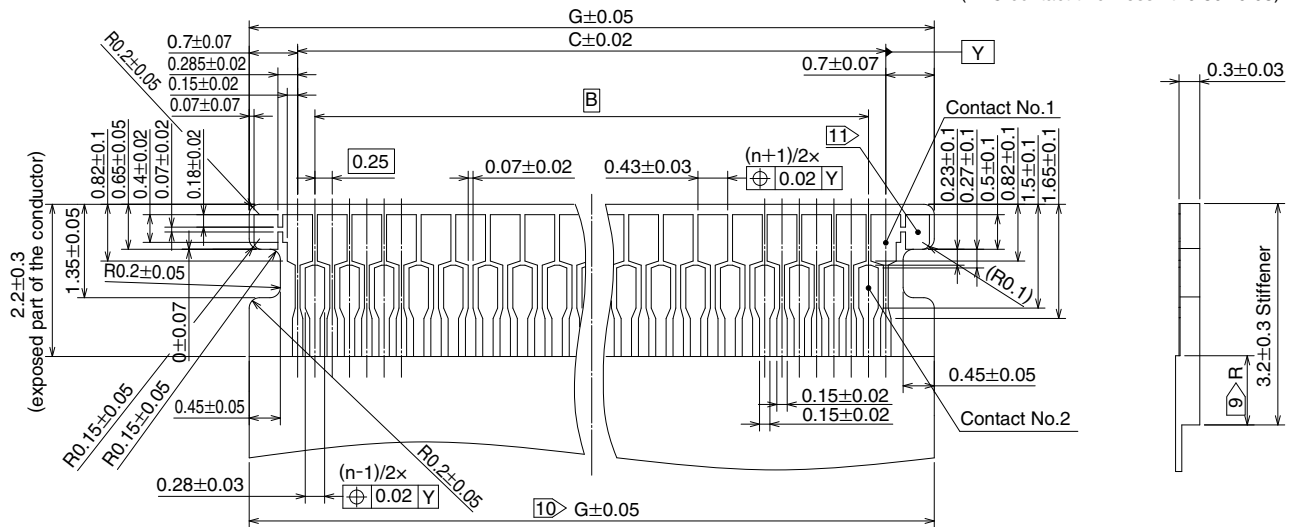

Note

- 9 Dimension R must be 0.5mm minimum.
- 10 Indicated tolerance is applicable to the exposed conductor.
- 11 Both end sides of contact pad on FPC cannot be used for signal transmission.

◆Recommended FPC Dimensions

Units : mm

Part No.	HRS No.	No. of contacts	B	C	G
FH62-13S-0.25SHW(**)	580-4308-0 **	13	2.5	3	4.4
FH62-15S-0.25SHW(**)	Under planning (Note 1)	15	3	3.5	4.9
FH62-17S-0.25SHW(**)	580-4303-0 **	17	3.5	4	5.4
FH62-19S-0.25SHW(**)	Under planning (Note 1)	19	4	4.5	5.9
FH62-21S-0.25SHW(**)	580-4312-0 **	21	4.5	5	6.4
FH62-23S-0.25SHW(**)	Under planning (Note 1)	23	5	5.5	6.9
FH62-25S-0.25SHW(**)	Under planning (Note 1)	25	5.5	6	7.4
FH62-27S-0.25SHW(**)	Under planning (Note 1)	27	6	6.5	7.9
FH62-31S-0.25SHW(**)	580-4310-0 **	31	7	7.5	8.9
FH62-35S-0.25SHW(**)	580-4300-0 **	35	8	8.5	9.9
FH62-39S-0.25SHW(**)	580-4302-0 **	39	9	9.5	10.9
FH62-41S-0.25SHW(**)	580-4305-0 **	41	9.5	10	11.4
FH62-51S-0.25SHW(**)	Under planning (Note 1)	51	12	12.5	13.9
FH62-55S-0.25SHW(**)	580-4309-0 **	55	13	13.5	14.9
FH62-61S-0.25SHW(**)	580-4306-0 **	61	14.5	15	16.4

Note 1 : Contact positions without HRS No. are currently under planning.
Please contact hirose for detailed information about product variation.

◆FPC Construction (Recommended Specifications)

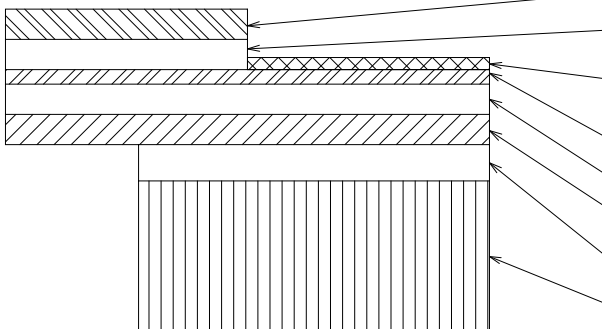

MATERIAL NAME	MATERIAL	THICKNESS (μm)
Covering film layer	Polyimide 1mil	25
Cover adhesive		25
Surface treatment	1μm to 6μm nickel underplated 0.2μm gold plated	(4)
Copper foil	Cu 1oz	35
Base adhesive	Heat-hardened adhesive	25
Base film	Polyimide 1mil	25
Reinforcement material adhesive	Heat-hardened adhesive	35
Stiffener	Polyimide 7mil	175

3. Caution

1. Material composition of FPC is a reference example. Please adjust the thickness of the FPC mating section to 0.3 ± 0.03 mm in reference to the material composition.
2. For the details of the material composition, please contact each FPC manufacturer.

◆ Packaging Specifications

● Embossed Carrier Tape Dimensions (Tape width up to 24mm)

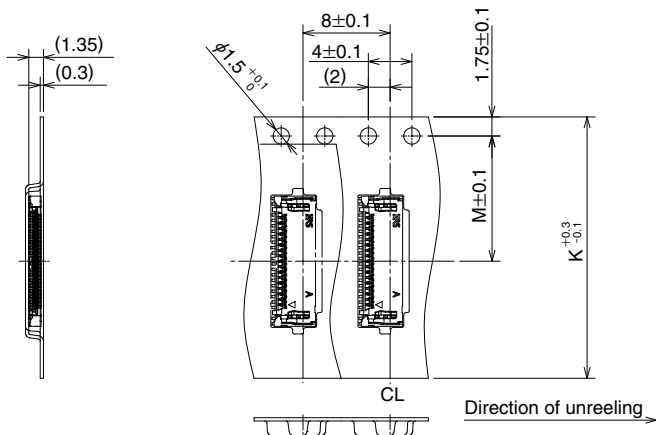

● Embossed Carrier Tape Dimensions (Tape width 32mm and over)

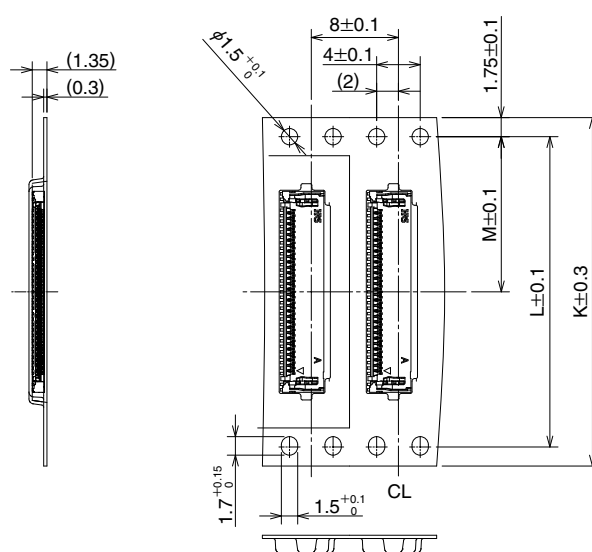

● Reel Dimensions

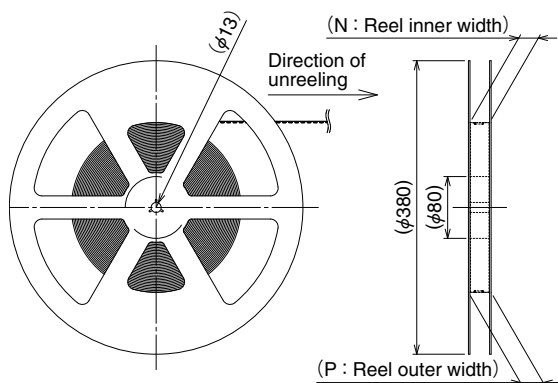

● Leader, Trailer Dimensions

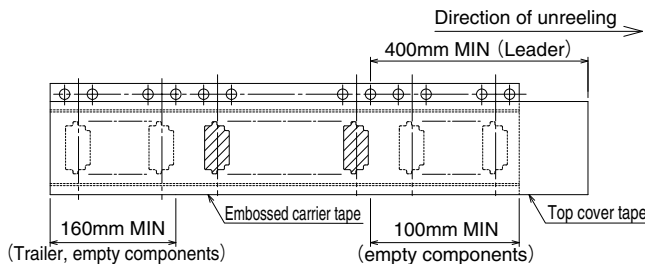

Units : mm

Part No.	HRS No.	No. of contacts	K	L	M	N	P
FH62-13S-0.25SHW(**)	580-4308-0 **	13	16	-	7.5	17.4	21.4
FH62-15S-0.25SHW(**)	Under planning (Note 1)	15	24	-	11.5	25.4	29.4
FH62-17S-0.25SHW(**)	580-4303-0 **	17					
FH62-19S-0.25SHW(**)	Under planning (Note 1)	19					
FH62-21S-0.25SHW(**)	580-4312-0 **	21					
FH62-23S-0.25SHW(**)	Under planning (Note 1)	23					
FH62-25S-0.25SHW(**)	Under planning (Note 1)	25					
FH62-27S-0.25SHW(**)	Under planning (Note 1)	27					
FH62-31S-0.25SHW(**)	580-4310-0 **	31					
FH62-35S-0.25SHW(**)	580-4300-0 **	35	32	28.4	14.2	33.4	37.4
FH62-39S-0.25SHW(**)	580-4302-0 **	39					
FH62-41S-0.25SHW(**)	580-4305-0 **	41					
FH62-51S-0.25SHW(**)	Under planning (Note 1)	51					
FH62-55S-0.25SHW(**)	580-4309-0 **	55					
FH62-61S-0.25SHW(**)	580-4306-0 **	61					

Note 1 : Contact positions without HRS No. are currently under planning.
Please contact hirose for detailed information about product variation.

◆ Temperature Profile

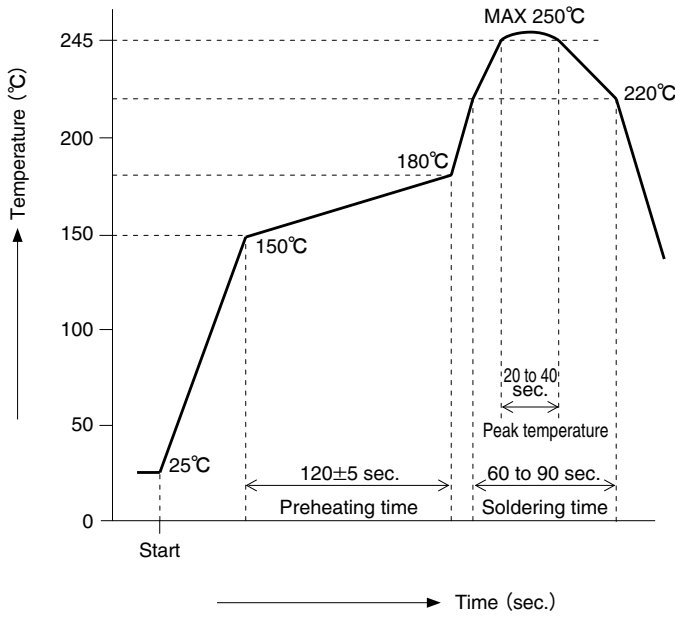

Applicable Conditions

- Reflow method : IR/Hot air
- Reflow environment : Room air
- Solder : Paste type Sn/3.0Ag/0.5Cu
(M705-GRN360-K2-V made by Senju Metal Industry Co.)
- Test PCB : PCB material and size
Glass epoxy 32.85×18.3×0.8mm
Land size, per recommended on page 4.
- Metal mask : Thickness and opening size
Per recommended on page 4.

This temperature profile is based on the above conditions. It may vastly depending on solder paste type, manufacturer, PCB size and mounting materials. Please use only after checking the mounting conditions.

◆ Connector operation and points to note

[Operation method]

As this connector is a small-sized, thin product, care needs to be taken when handling. Please check the following before use.

1. Initial condition

- ① The product is delivered with the lock lever closed, you do not need to operate it except for when removing the FPC.

2. How to insert FPC

- ① Insert FPC with the conductor surface facing upwards, horizontal to the board surface.

[Caution]

- During FPC insertion, do not twist the FPC to up and down, right and left or an angle. It may cause deformation of the contacts and contact failure.

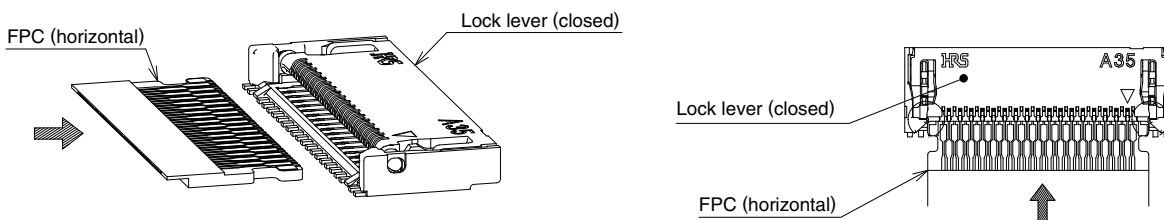

NG

NG

NG

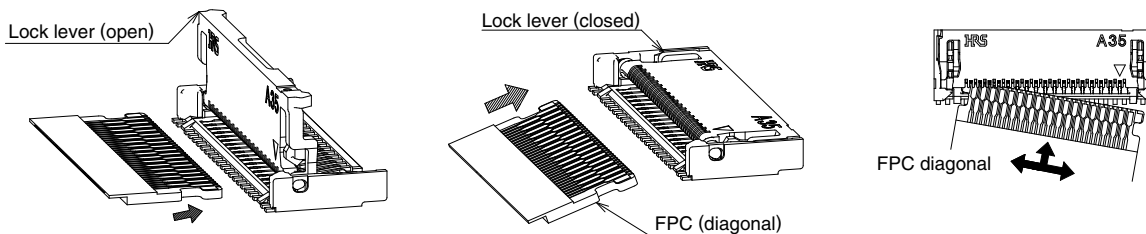

3. Check the inserted state of FPC

When FPC is completely inserted, visually inspect the status.

OK

NG

NG



The outer shapes of FPC and the lock lever are parallel and inserted to the end.



FPC is not inserted deep enough.



FPC is inserted diagonally.

Connector operation and points to note

[Operation method]

4. How to remove FPC

- 1 Push up the lock lever slowly, and release the lock.

[Caution]

- The lock lever can't be opened over 180°.
- After releasing the lock lever, do not touch the contact.
- Do not raise, pull, or twist the lock lever.

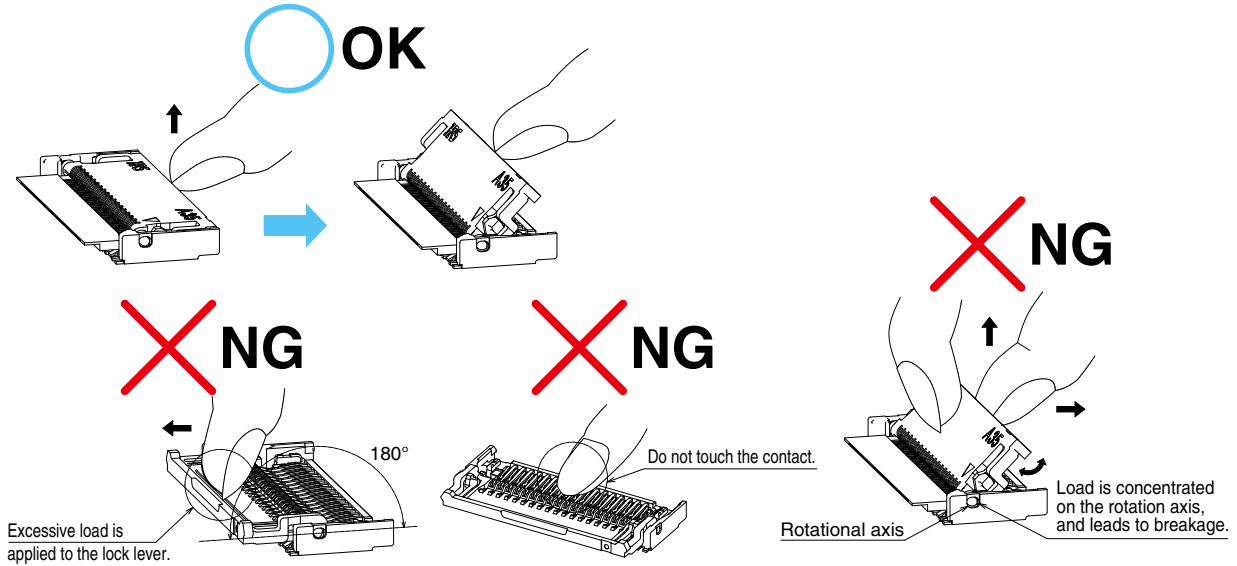

- 2 After releasing the lock lever, remove the FPC in the horizontal direction.
- 3 After remove of the FPC, close the lock lever.

[Caution]

- Do not pull out FPC while the lock lever is not opened to 45° or more.
- Ensure both ends of the lock lever are closed.

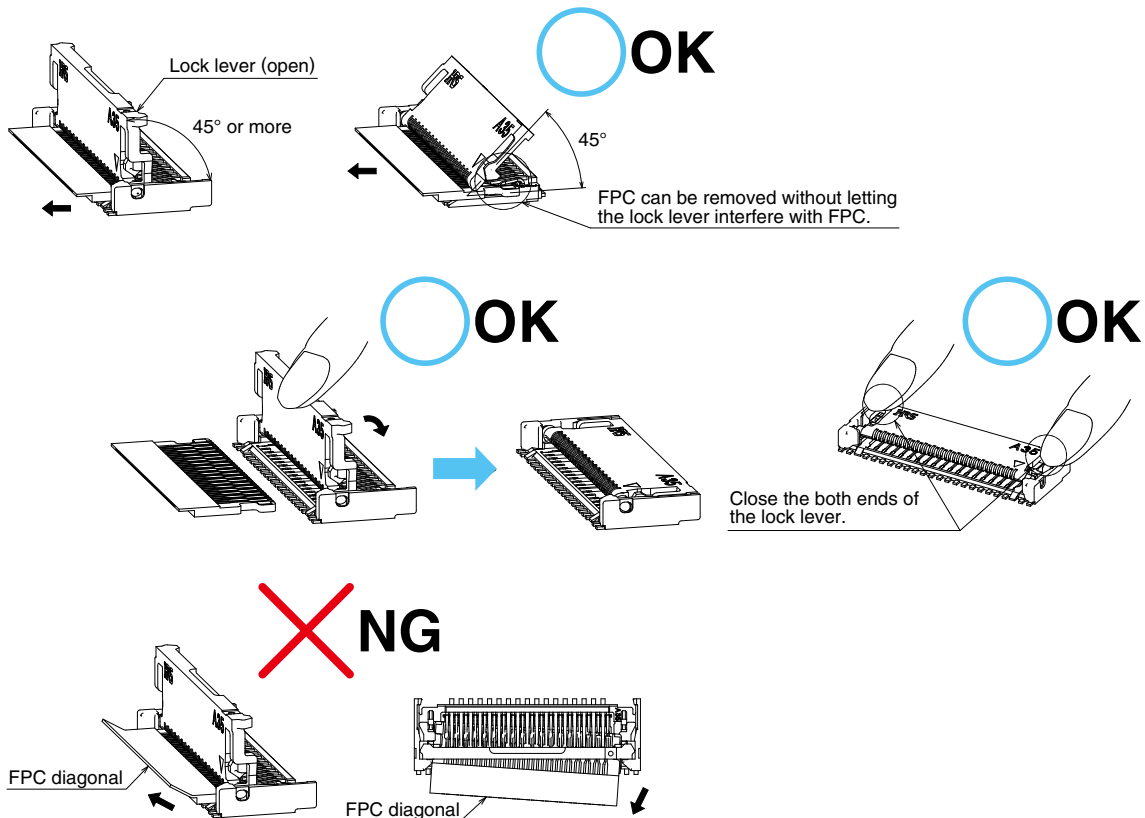

◆ Connector operation and points to note

[Operation methods]

5. FPC routing after connection

- ① Depending on a FPC rounding, a load is applied to connector, and a contact failure may occur. To prevent a failure, take the following notes into a consideration during mechanism design.

[Caution]

- Make sure that FPC and stiffener do not contact chassis.
- Avoid applying forces to FPC in vertical or horizontal directions. In addition, avoid pulling up and down on the FPC.
- When fixing FPC after FPC cabling, avoid pulling FPC, and route the wire FPC with slack. In this regard, the stiffener is parallel to the PCB.
- Do not mount other components touching to the FPC underneath the FPC stiffener.

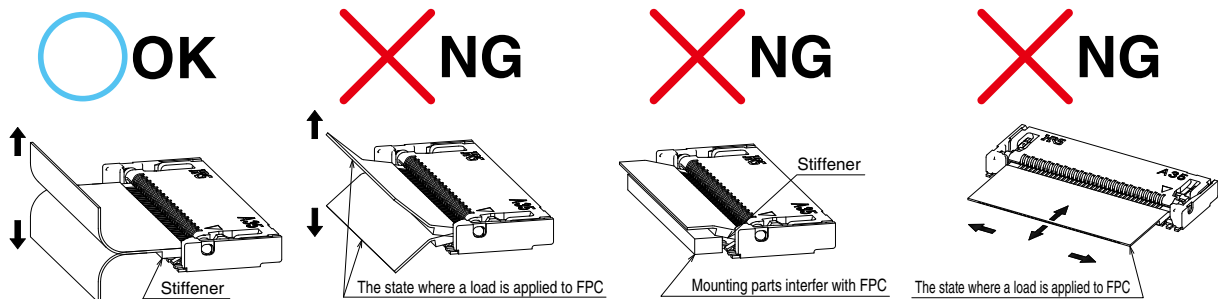

[Cautions when Mounting PCB]

◆ Warp of PCB

Minimize warp of the PCB as much as possible.
Lead co-planarity including reinforced metals is 0.1mm or less.
Too much warp of the PCB may result in a soldering failure.

◆ Flexible board design

Please make sure to put a stiffener on the backside of the flexible board.
We recommend a glass epoxy material with the thickness of 0.3mm MIN.

◆ Load to Connector

Do not add 1.0N or greater external force when unreel or pick and place the connector etc, or it may get broken.
In addition, do not insert the FPC or operate the connector before mounting.

◆ Load to PCB

- Splitting a large PCB into several pieces
 - Screwing the PCB
- Avoid the handling described above so that no force is exerted on the PCB during the assembly process. Otherwise, the connector may become defective.

◆ Instructions on manual soldering

Follow the instructions shown below when soldering the connector manually during work, etc.

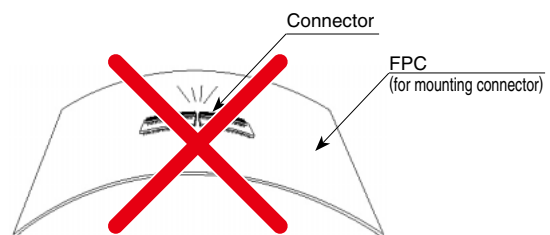

- ① Do not perform any reflow or hand soldering operation while FPC is inserted in the connector.
- ② Do not apply extreme heat, or allow the soldering iron to touch anything other than the connector lead. This could cause the connector to be deformed or melted.
- ③ Do not supply excessive solder (flux).
If excessive solder (flux) is applied to the contact, the solder or flux could adhere on the contact point and cause contact failure.

MEMO :

A series of horizontal dashed lines for writing a memo.

Apr. 1. 2024 Copyright 2024 HIROSE ELECTRIC CO., LTD. All Rights Reserved.

HIROSE ELECTRIC CO.,LTD.

2-6-3,Nakagawa Chuoh,Tsuzuki-Ku,Yokohama-Shi 224-8540,JAPAN
<https://www.hirose.com/>

