

MIL-DTL-83503 Compliant IDC Ribbon Cable Connectors



Features

- 1 MIL-DTL-83503 Compliant**
 - Improved operability version of the HIF3B series.
 - Compatible with the HIF3 series
- 2 Wide Range of Configurations**
 - Available in all MIL-specified positions
 - Mating compatible with original HRS pin headers
- 3 Mismatching Prevention Design**
- 4 Superior Operability**
 - Improved insertion and withdrawal through a wider pin-header lock and deeper socket clamp compared to the HIF3B series.
 - Simplified IDC cable termination with separate socket body and protector.
- 5 UL Certified (File E52653, Vol. 4, Sec. 2)**

Click here to view the series page.

https://www.hirose.com/ja/product/series/HIF3M*W

Product Specifications

Rated Current	IDC: 1A(28 AWG) Crimp: 1A(32 AWG, 36 AWG), 3A(Others)
Rated Voltage	200V AC
Operating Temperature (Note)	-55°C~+85°C
Mating Durability	500 times

(Note) Includes temperature rise due to current flow.

Materials / Finish

Part	Materials	Finish	Remarks
Pin Header Lock	PBT	Black	UL94V-0
Pin Header/Socket Insulator	PBT	Black	-
Pin Header Contact	Brass	Contacted Part: Gold Plating Through Hole Part: Pure Tin Plating	-
Socket IDC Contact	Copper Alloy	Contacted Part: Gold Plating IDC Part: Nickel Plating	-
Polarizing Key	PBT	Black	UL94V-0

Refer to the chart below when determining the product specifications from the product number. Please select from the product numbers listed in this catalog when placing orders.

■ Right Angle Pin Header

HIF3 **M#W** - **#** **PB** - **2.54** **DS**
 1 2 3 4 5 6

■ Straight Pin Header

HIF3 **M#W** - **#** **PB** - **2.54** **DSA**
 1 2 3 4 5 6

■ Socket

HIF3 **M#W** - **#** **D** - **2.54** **R**
 1 2 3 4 5 6

1 Series Name	HIF3M*W
2 Style Symbol	MAW: Pin Header/Socket all No. of pos. MBW: Pin Header/Socket 50,60,64 pos., Socket with misinsertion prevention guide MCW: Pin Header/Flux Blister Prevention MDW: Pin Header 10 pos.
3 No. of Pos.	10,14,16,20,26,30,34,40,50,60,64
4 Connector Type	P: Pin Header B: Partial three-side gold plating: the mating terminal contact area has a minimum gold thickness of 0.15 μm, and the remaining two sides (sheared surfaces) have a minimum gold thickness of 0.08 μm. D: Socket
5 Contact Pitch	2.54mm
6 Contact Type	DS: Right Angle Through Hole DSA: Straight Through Hole R: IDC WB: Long-lead right-angle Through Hole

Jun.1.2026 Copyright 2026 HIROSE ELECTRIC CO., LTD. All Rights Reserved.

■ HIF3 Series Applicable Combination Wire-to-Board

Receptacle Socket Side

Header Side

◆ IDC connector
HIF3MAW-#D-2.54R
HIF3MBW-#D-2.54R

◆ IDC connector
HIF3A-#D-2.54R
HIF3B-#D-2.54R
HIF3BA-#D-2.54R

⚠ HIF3A-60D-2.54R and MIL type pin header can be mated only with HIF3BAE-60PA-2.54DS(A) Allows mating with other different number of positions and box type pin headers of HIF3A Series.

◆ Crimp connector
HIF3BA-#D-2.54C

MIL type pin header
HIF3M#W Series

◆ Straight type with lock
HIF3MAW- #PB-2.54DSA
HIF3MBW- #PB-2.54DSA
HIF3MDW- #PB-2.54DSA

◆ Right angle type with lock
HIF3MAW- #PB-2.54DS
HIF3MBW- #PB-2.54DS
HIF3MDW- #PB-2.54DS

Box type pin header
HIF3F Series

◆ Straight type
HIF3F-#PA-2.54DSA

◆ Right angle type
HIF3F-#PA-2.54DS

Low-profile box type pin header
HIF3FB(C) Series

◆ Straight type
HIF3FB-#PA-2.54DSA
HIF3FC-#PA-2.54DSA

◆ Right angle type
HIF3FB-#PA-2.54DS
HIF3FC-#PA-2.54DS

Pin header
HIF3E Series

◆ Straight type
HIF3E-#PA-2.54DSA

◆ Right angle type
HIF3E-#PA-2.54DS

Pin header
A1 Series

◆ Straight type
A1-#PA-2.54DSA

◆ Right angle type
A1-#PA-2.54DS

Ribbon cable plug
HIF3B In-line type

◆ In-line type
HIF3BA-#PD-2.54R-MC

Jun.1.2026 Copyright 2026 HIROSE ELECTRIC CO., LTD. All Rights Reserved.

■ HIF3M*W Series Polarization List

Socket Type				Header Type				
Socket side Part No.	Polarizing guide	Polarizing key	Socket appearance	No. of Pos.	Pin header appearance	Polarizing slot	Polarizing key	Pin header Part No.
				10		0	1	•HIF3MAW-10PB-2.54DS(A)
•HIF3MAW-10D-2.54R	1	1				1	0	•HIF3MDW-10PB-2.54DS(A)
•HIF3MAW-14D-2.54R	1	1		14		1	1	•HIF3MAW-14PB-2.54DS(A)
•HIF3MAW-16D-2.54R •HIF3MAW-20D-2.54R •HIF3MAW-26D-2.54R •HIF3MAW-30D-2.54R •HIF3MAW-34D-2.54R •HIF3MAW-40D-2.54R	1	2		16 to 40		1	2	•HIF3MAW-16PB-2.54DS(A) •HIF3MAW-20PB-2.54DS(A) •HIF3MAW-26PB-2.54DS(A) •HIF3MAW-30PB-2.54DS(A) •HIF3MAW-34PB-2.54DS(A) •HIF3MAW-40PB-2.54DS(A)
•HIF3MBW-50D-2.54R •HIF3MBW-60D-2.54R •HIF3MBW-64D-2.54R	1	2		50 to 64		1	2	•HIF3MBW-50PB-2.54DS(A) •HIF3MBW-60PB-2.54DS(A) •HIF3MBW-64PB-2.54DS(A)
•HIF3MAW-50D-2.54R •HIF3MAW-60D-2.54R •HIF3MAW-64D-2.54R	2	2				2	2	•HIF3MAW-50PB-2.54DS(A) •HIF3MAW-60PB-2.54DS(A) •HIF3MAW-64PB-2.54DS(A)

■ Pin Configuration Correlation Diagram

When terminal Nos. are arranged as 1,2,3,4n beginning from the side of the polarizing mark, contact positions are as shown in the diagram below.

●Right angle dip solder

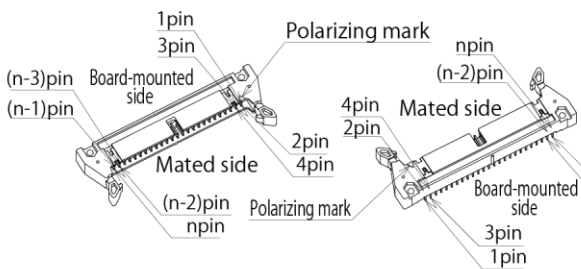

●Straight dip solder

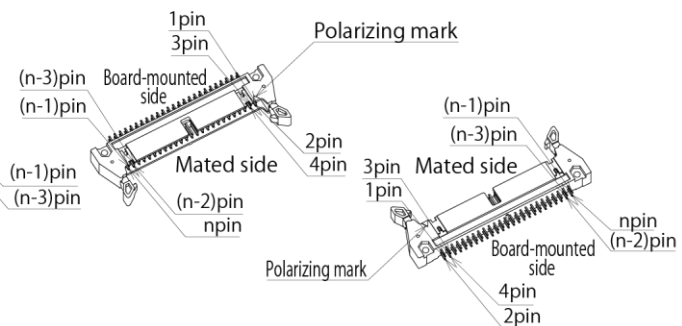

●Socket type

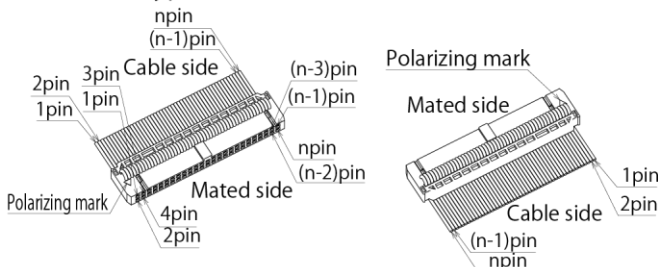

Compatible Mating Combinations

10 pos.

- ◆ Socket
 - HIF3MAW-10D-2.54R



- ◆ Pin header
 - HIF3MDW-10PB-2.54DS(A)
 - Number of polarizing guides 1 = Number of polarizing slots 1

50 to 64 pos.

- ◆ Socket
 - HIF3MAW-#D-2.54R



- ◆ Pin header
 - HIF3MAW-#PB-2.54DS(A)
 - Number of polarizing guides 2 = Number of polarizing slots 2

50 to 64 pos.

- ◆ Socket
 - HIF3MBW-#D-2.54R



- ◆ Pin header
 - HIF3MBW-#PB-2.54DS(A)
 - Number of polarizing guides 1 = Number of polarizing slots 1

Incompatible Mating Combinations

10 pos.

- ◆ Socket
 - HIF3MAW-10D-2.54R



- ◆ Pin header
 - HIF3MAW-10PB-2.54DS(A)
 - Number of polarizing guides 1 ≠ Number of polarizing slots 0



50 to 64 pos.

- ◆ Socket
 - HIF3MAW-#D-2.54R



- ◆ Pin header
 - HIF3MBW-#PB-2.54DS(A)
 - Number of polarizing guides 2 ≠ Number of polarizing slots 1

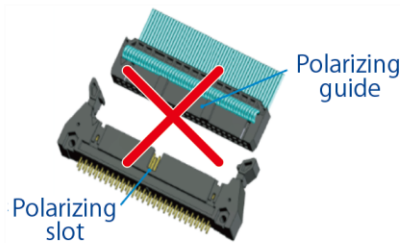

50 to 64 pos.

- ◆ Socket
 - HIF3MBW-#D-2.54R



- ◆ Pin header
 - HIF3MAW-#PB-2.54DS(A)
 - Number of polarizing guides 1 ≠ Number of polarizing slots 2

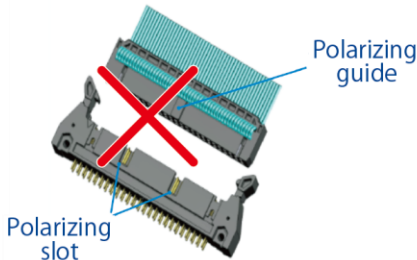

The following shows the connection circuit diagram for the cable-connected HIF3M#W-##D-2.54R.

...Polarizing Mark Position

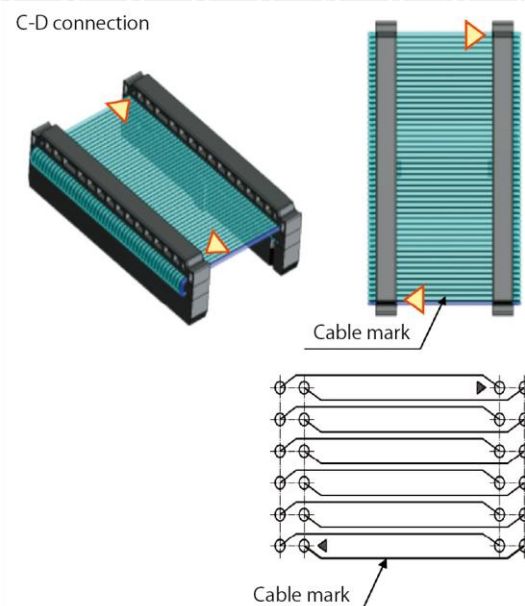
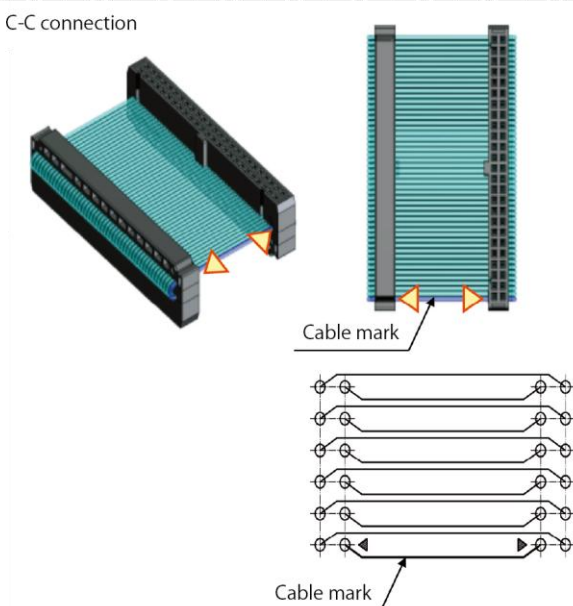
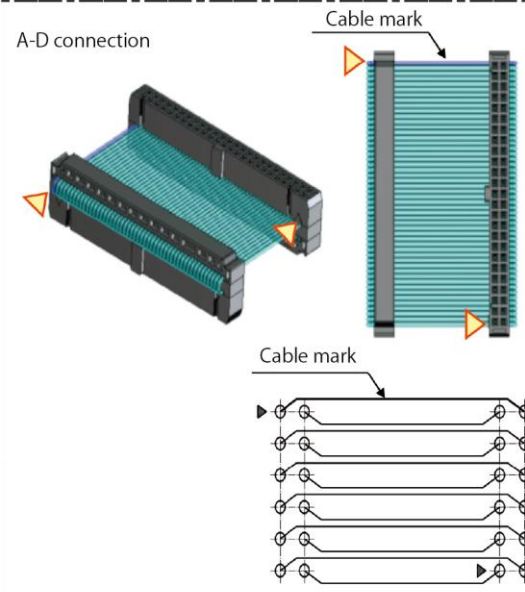
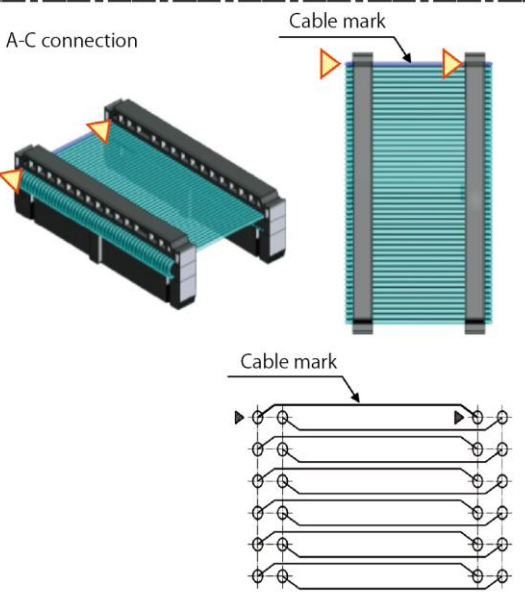
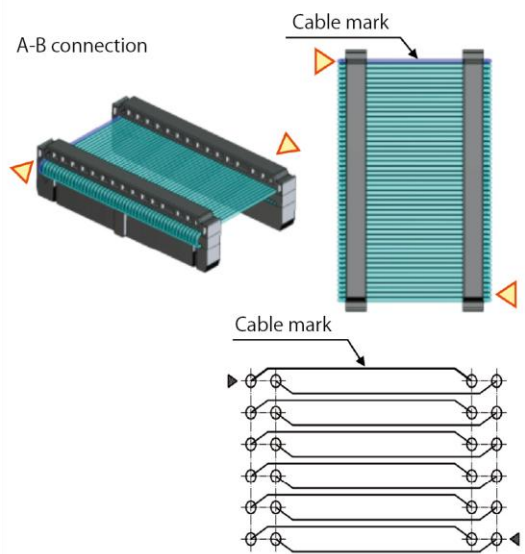
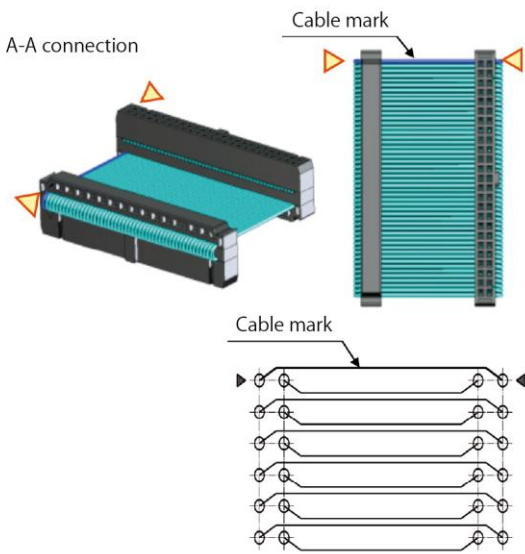

Jun. 1. 2026 Copyright 2026 HIROSE ELECTRIC CO., LTD. All Rights Reserved.

Right Angle Header / 4 Wall Through Hole

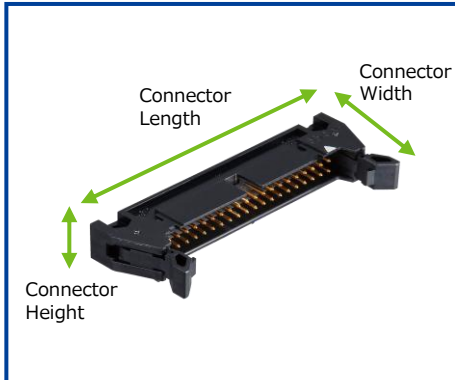

* Please refer to the following 2D drawing links for connector dimensions, recommended PCB dimensions, and other notes.

(mm)

HRS No.	Part No.	No. of Pos.	WEB Link	2D	SPEC	3D		Connector Length	Connector Width	Connector Height	Polarizing Slot	Polarizing key	MIL
CL0610-3025-0-63	HIF3MAW-10PB-2.54DS(63)	10	WEB	2D	SPEC	IGES	STEP	32.0	26.6	9.0	0	1	○
CL0610-3039-0-63	HIF3MDW-10PB-2.54DS(63)	10	WEB	2D	SPEC	IGES	STEP	32.0	26.6	9.0	1	0	—
CL0610-3026-0-63	HIF3MAW-14PB-2.54DS(63)	14	WEB	2D	SPEC	IGES	STEP	37.1	26.6	9.0	1	1	○
CL0610-3027-0-63	HIF3MAW-16PB-2.54DS(63)	16	WEB	2D	SPEC	IGES	STEP	39.6	26.6	9.0	1	2	○
CL0610-3028-0-63	HIF3MAW-20PB-2.54DS(63)	20	WEB	2D	SPEC	IGES	STEP	44.7	26.6	9.0	1	2	○
CL0610-3029-0-63	HIF3MAW-26PB-2.54DS(63)	26	WEB	2D	SPEC	IGES	STEP	52.3	26.6	9.0	1	2	○
CL0610-3030-0-63	HIF3MAW-30PB-2.54DS(63)	30	WEB	2D	SPEC	IGES	STEP	57.4	26.6	9.0	1	2	○
CL0610-3031-0-63	HIF3MAW-34PB-2.54DS(63)	34	WEB	2D	SPEC	IGES	STEP	62.5	26.6	9.0	1	2	○
CL0610-3032-0-63	HIF3MAW-40PB-2.54DS(63)	40	WEB	2D	SPEC	IGES	STEP	70.1	26.6	9.0	1	2	○
CL0610-3033-0-63	HIF3MAW-50PB-2.54DS(63)	50	WEB	2D	SPEC	IGES	STEP	82.8	26.6	9.0	2 ※	2	○
CL0610-3036-0-63	HIF3MBW-50PB-2.54DS(63)	50	WEB	2D	SPEC	IGES	STEP	82.8	26.6	9.0	1	2	○
CL0610-3034-0-63	HIF3MAW-60PB-2.54DS(63)	60	WEB	2D	SPEC	IGES	STEP	95.5	26.6	9.0	2 ※	2	○
CL0610-3037-0-63	HIF3MBW-60PB-2.54DS(63)	60	WEB	2D	SPEC	IGES	STEP	95.5	26.6	9.0	1	2	○
CL0610-3035-0-63	HIF3MAW-64PB-2.54DS(63)	64	WEB	2D	SPEC	IGES	STEP	100.6	26.6	9.0	2 ※	2	○
CL0610-3038-0-63	HIF3MBW-64PB-2.54DS(63)	64	WEB	2D	SPEC	IGES	STEP	100.6	26.6	9.0	1	2	○

(Note 1) As the number of polarizing slots and polarizing keys differs for each part, please refer to the upper table, 2D and 3D.

(Note 2) The spacer moves to the right according to the number of positions.

(Note 3) Pitch of polarizing guide is 22.86mm.

(Note 4) MIL: MIL compliant

Straight Header / 4 Wall Through Hole

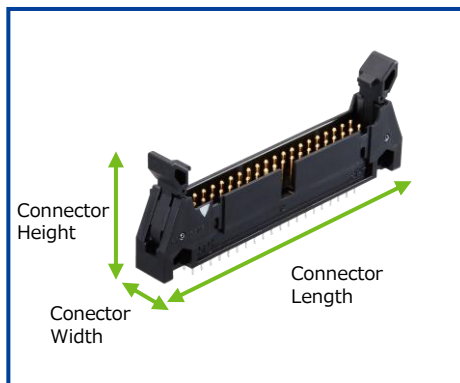

* Please refer to the following 2D drawing links for connector dimensions, recommended PCB dimensions, and other notes.

(mm)

HRS No.	Part No.	No. of Pos.	WEB Link	2D	SPEC	3D		Connector Length	Connector Width	Connector Height	Polarizing Slot	Polarizing key	MIL
CL0610-1088-0-63	HIF3MAW-10PB-2.54DSA(63)	10	WEB	2D	SPEC	IGES	STEP	32.0	9.0	26.6	0	1	○
CL0610-3024-0-63	HIF3MDW-10PB-2.54DSA(63)	10	WEB	2D	SPEC	IGES	STEP	32.0	9.0	26.6	1	0	—
CL0610-1089-0-63	HIF3MAW-14PB-2.54DSA(63)	14	WEB	2D	SPEC	IGES	STEP	37.1	9.0	26.6	1	1	○
CL0610-1090-0-63	HIF3MAW-16PB-2.54DSA(63)	16	WEB	2D	SPEC	IGES	STEP	39.6	9.0	26.6	1	2	○
CL0610-1091-0-63	HIF3MAW-20PB-2.54DSA(63)	20	WEB	2D	SPEC	IGES	STEP	44.7	9.0	26.6	1	2	○
CL0610-1092-0-63	HIF3MAW-26PB-2.54DSA(63)	26	WEB	2D	SPEC	IGES	STEP	52.3	9.0	26.6	1	2	○
CL0610-1093-0-63	HIF3MAW-30PB-2.54DSA(63)	30	WEB	2D	SPEC	IGES	STEP	57.4	9.0	26.6	1	2	○
CL0610-1094-0-63	HIF3MAW-34PB-2.54DSA(63)	34	WEB	2D	SPEC	IGES	STEP	62.5	9.0	26.6	1	2	○
CL0610-1095-0-63	HIF3MAW-40PB-2.54DSA(63)	40	WEB	2D	SPEC	IGES	STEP	70.1	9.0	26.6	1	2	○
CL0610-1096-0-63	HIF3MAW-50PB-2.54DSA(63)	50	WEB	2D	SPEC	IGES	STEP	82.8	9.0	26.6	2 ※	2	○
CL0610-1099-0-63	HIF3MBW-50PB-2.54DSA(63)	50	WEB	2D	SPEC	IGES	STEP	82.8	9.0	26.6	1	2	○
CL0610-1097-0-63	HIF3MAW-60PB-2.54DSA(63)	60	WEB	2D	SPEC	IGES	STEP	95.5	9.0	26.6	2 ※	2	○
CL0610-3022-0-63	HIF3MBW-60PB-2.54DSA(63)	60	WEB	2D	SPEC	IGES	STEP	95.5	9.0	26.6	1	2	○
CL0610-1098-0-63	HIF3MAW-64PB-2.54DSA(63)	64	WEB	2D	SPEC	IGES	STEP	100.6	9.0	26.6	2 ※	2	○
CL0610-3023-0-63	HIF3MBW-64PB-2.54DSA(63)	64	WEB	2D	SPEC	IGES	STEP	100.6	9.0	26.6	1	2	○

(Note 1) As the number of polarizing slots and polarizing keys differs for each part, please refer to the upper table, 2D and 3D.

(Note 2) The spacer moves to the right according to the number of positions.

(Note 3) Pitch of polarizing guide is 22.86mm.

(Note 4) MIL: MIL compliant

Straight Header / 4 wall Through Hole Flux Wicking Resistant Type

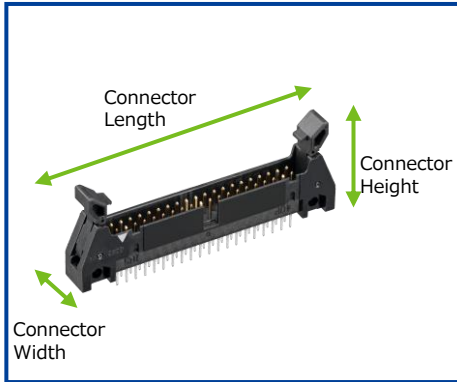

* Please refer to the following 2D drawing links for connector dimensions, recommended PCB dimensions, and other notes.

(mm)

HRS No.	Part No.	No. of Pos.	WEB Link	2D	SPEC	3D	Connector Length	Connector Width	Connector Height	Polarizing Slot	Polarizing key	MIL
CL0610-0396-0-63	HIF3MCAW-10PB-2.54DSA(63)	10	WEB	2D	SPEC	IGES STEP	32	8.5	27.3	0	1	○
CL0610-0676-0-63	HIF3MCDW-10PB-2.54DSA(63)	10	WEB	2D	SPEC	IGES STEP	32	8.5	27.3	1	0	—
CL0610-0397-0-63	HIF3MCAW-16PB-2.54DSA(63)	16	WEB	2D	SPEC	IGES STEP	39.6	8.5	27.3	1	2	○
CL0610-0398-0-63	HIF3MCAW-20PB-2.54DSA(63)	20	WEB	2D	SPEC	IGES STEP	44.7	8.5	27.3	1	2	○
CL0610-0399-0-63	HIF3MCAW-26PB-2.54DSA(63)	26	WEB	2D	SPEC	IGES STEP	52.3	8.5	27.3	1	2	○
CL0610-0595-0-63	HIF3MCAW-30PB-2.54DSA(63)	30	WEB	2D	SPEC	IGES STEP	57.4	8.5	27.3	1	2	○
CL0610-0596-0-63	HIF3MCAW-34PB-2.54DSA(63)	34	WEB	2D	SPEC	IGES STEP	62.5	8.5	27.3	1	2	○
CL0610-0597-0-63	HIF3MCAW-40PB-2.54DSA(63)	40	WEB	2D	SPEC	IGES STEP	70.1	8.5	27.3	1	2	○
CL0610-0598-0-63	HIF3MCAW-50PB-2.54DSA(63)	50	WEB	2D	SPEC	IGES STEP	82.8	8.5	27.3	2 ※	2	○
CL0610-0599-0-63	HIF3MCBW-50PB-2.54DSA(63)	50	WEB	2D	SPEC	IGES STEP	82.8	8.5	27.3	1	2	○
CL0610-0674-0-63	HIF3MCBW-60PB-2.54DSA(63)	60	WEB	2D	SPEC	IGES STEP	95.5	8.5	27.3	1	2	○
CL0610-0675-0-63	HIF3MCBW-64PB-2.54DSA(63)	64	WEB	2D	SPEC	IGES STEP	100.6	8.5	27.3	1	2	○

(Note 1) As the number of polarizing slots and polarizing keys differs for each part, please refer to the upper table, 2D and 3D.

(Note 2) The spacer moves to the right according to the number of positions.

(Note 3) Pitch of polarizing guide is 22.86mm.

(Note 4) MIL: MIL compliant

Right Angle Through-Hole Pin Header for Stacking

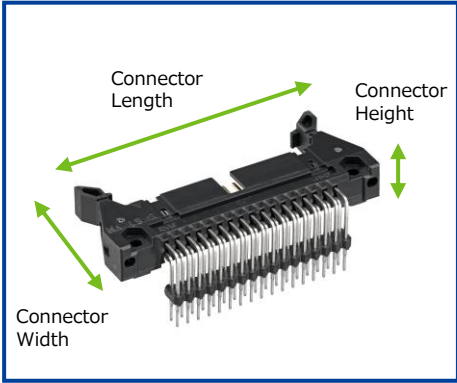

* Please refer to the following 2D drawing links for connector dimensions, recommended PCB dimensions, and other notes.

(mm)

HRS No.	Part No.	No. of Pos.	WEB Link	2D	SPEC	3D		Connector Length	Connector Width	Connector Height	Polarizing Slot	Polarizing Key	MIL
CL0610-0382-0-63	HIF3MAW-10PB-2.54WB(63)	10	WEB	2D	SPEC	IGES	STEP	32	20.6	18	0	1	○
CL0610-0395-0-63	HIF3MDW-10PB-2.54WB(63)	10	WEB	2D	SPEC	IGES	STEP	32	20.6	18	1	0	—
CL0610-0383-0-63	HIF3MAW-16PB-2.54WB(63)	16	WEB	2D	SPEC	IGES	STEP	39.6	20.6	18	1	2	○
CL0610-0384-0-63	HIF3MAW-20PB-2.54WB(63)	20	WEB	2D	SPEC	IGES	STEP	44.7	20.6	18	1	2	○
CL0610-0385-0-63	HIF3MAW-26PB-2.54WB(63)	26	WEB	2D	SPEC	IGES	STEP	52.3	20.6	18	1	2	○
CL0610-0386-0-63	HIF3MAW-30PB-2.54WB(63)	30	WEB	2D	SPEC	IGES	STEP	57.4	20.6	18	1	2	○
CL0610-0387-0-63	HIF3MAW-34PB-2.54WB(63)	34	WEB	2D	SPEC	IGES	STEP	62.5	20.6	18	1	2	○
CL0610-0388-0-63	HIF3MAW-40PB-2.54WB(63)	40	WEB	2D	SPEC	IGES	STEP	70.1	20.6	18	1	2	○
CL0610-0389-0-63	HIF3MAW-50PB-2.54WB(63)	50	WEB	2D	SPEC	IGES	STEP	82.8	20.6	18	2 ※	2	○
CL0610-0392-0-63	HIF3MBW-50PB-2.54WB(63)	50	WEB	2D	SPEC	IGES	STEP	82.8	20.6	18	1	2	○
CL0610-0390-0-63	HIF3MAW-60PB-2.54WB(63)	60	WEB	2D	SPEC	IGES	STEP	95.5	20.6	18	2 ※	2	○
CL0610-0393-0-63	HIF3MBW-60PB-2.54WB(63)	60	WEB	2D	SPEC	IGES	STEP	95.5	20.6	18	1	2	○
CL0610-0391-0-63	HIF3MAW-64PB-2.54WB(63)	64	WEB	2D	SPEC	IGES	STEP	100.6	20.6	18	2 ※	2	○
CL0610-0394-0-63	HIF3MBW-64PB-2.54WB(63)	64	WEB	2D	SPEC	IGES	STEP	100.6	20.6	18	1	2	○

(Note 1) As the number of polarizing slots and polarizing keys differs for each part, please refer to the upper table, 2D and 3D.

(Note 2) The spacer moves to the right according to the number of positions.

(Note 3) Pitch of polarizing guide is 22.86mm.

(Note 4) MIL: MIL compliant

IDC Socket (With a Mis-insertion Prevention Guide)

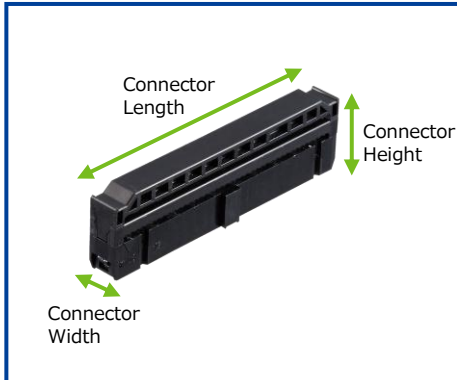

* Please refer to the following 2D drawing links for connector dimensions, recommended PCB dimensions, and other notes.

(mm)

HRS No.	Part No.	No. of Pos.	WEB Link	2D	SPEC	3D		Connector Length	Connector Width	Connector Height	Polarizing Guide	Polarizing keyway	MIL
CL0610-3002-9-63	HIF3MAW-10D-2.54R(63)	10	WEB	2D	SPEC	IGES	STEP	17.27	6.0	15.6	1	1	—
CL0610-3003-1-63	HIF3MAW-14D-2.54R(63)	14	WEB	2D	SPEC	IGES	STEP	22.35	6.0	15.6	1	2	○
CL0610-3004-4-63	HIF3MAW-16D-2.54R(63)	16	WEB	2D	SPEC	IGES	STEP	24.89	6.0	15.6	1	2	○
CL0610-2097-0-63	HIF3MAW-20D-2.54R(63)	20	WEB	2D	SPEC	IGES	STEP	29.97	6.0	15.6	1	2	○
CL0610-3005-7-63	HIF3MAW-26D-2.54R(63)	26	WEB	2D	SPEC	IGES	STEP	37.59	6.0	15.6	1	2	○
CL0610-2098-2-63	HIF3MAW-30D-2.54R(63)	30	WEB	2D	SPEC	IGES	STEP	42.67	6.0	15.6	1	2	○
CL0610-2099-5-63	HIF3MAW-34D-2.54R(63)	34	WEB	2D	SPEC	IGES	STEP	47.75	6.0	15.6	1	2	○
CL0610-2100-2-63	HIF3MAW-40D-2.54R(63)	40	WEB	2D	SPEC	IGES	STEP	55.37	6.0	15.6	1	2	○
CL0610-2101-5-63	HIF3MAW-50D-2.54R(63)	50	WEB	2D	SPEC	IGES	STEP	68.07	6.0	15.6	2 ※	2	○
CL0610-2114-7-63	HIF3MBW-50D-2.54R(63)	50	WEB	2D	SPEC	IGES	STEP	68.07	6.0	15.6	1	2	○
CL0610-2102-8-63	HIF3MAW-60D-2.54R(63)	60	WEB	2D	SPEC	IGES	STEP	80.77	6.0	15.6	2 ※	2	○
CL0610-2115-0-63	HIF3MBW-60D-2.54R(63)	60	WEB	2D	SPEC	IGES	STEP	80.77	6.0	15.6	1	2	○
CL0610-3006-0-63	HIF3MAW-64D-2.54R(63)	64	WEB	2D	SPEC	IGES	STEP	85.85	6.0	15.6	2 ※	2	○
CL0610-0013-0-63	HIF3MBW-64D-2.54R(63)	64	WEB	2D	SPEC	IGES	STEP	85.85	6.0	15.6	1	2	○

(Note 1) As the number of polarizing guides and polarizing keyways differs for each part, please refer to the upper table, 2D and 3D.

(Note 2) Pitch of polarizing guide is 22.86mm.

(Note 3) MIL: MIL compliant

Polarizing Key



HRS No.	Part No.	WEB Link	2D	SPEC	3D	
CL0562-0601-8-00	HIF3B-GK	WEB	2D	SPEC	IGES	STEP

How to Use the Polarizing Key

1. Insert the polarizing key in the direction shown.



2. Keep the polarizing key inserted.

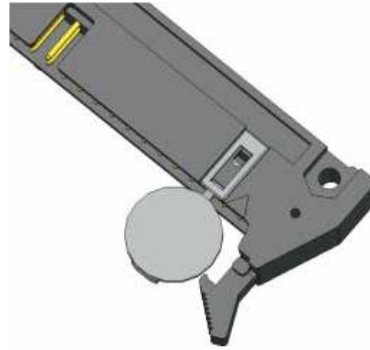

3. Break off the tab.



Front View After Installation

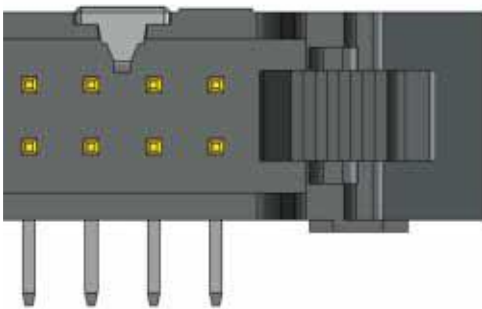

Applicable Wire

Wire Size (Stranded Wire Conductor)	Jacket Diameter
28 AWG flat cable (7 conductors/0.127mm) <UL2651>	0.9±0.1mm

Applicable IDC Tool

Type	HRS No.	Part No.	WEB Link	Document
IDC Connection	CL0550-0082-2-00	HI-FLEX-HHP502	WEB	DOC
Guide Plate	CL0550-0156-7-00	HIF3-GPA2	WEB	
Pressure Block	CL0550-0133-1-00	PRESS BLOCK A-01	WEB	DOC

(Note 1) Common to all No. of positions.

(Note 2) For details of cable wiring, please refer to the documentation "HIF Series Ribbon Cable Connection Instruction Manual" for the insulation displacement (IDC) press HI-FLEX-HHP502.

(Note 3) The HIF3M*W Series supports IDC termination using the same dedicated tools as the HIF3 Series.

While taking into consideration

Specifications mentioned in this catalog are reference values.

When considering to order or use this product, please review the Drawing and Product Specifications sheets.

Use an appropriate cable when using the connector in combination with cables.

If considering usage of a non-specified cable, please contact your sales representative.

If assembly process is done by jigs & tools which are not identified by Hirose, the warranty of the product may be affected.

If considering usage for below mentioned applications, please contact your sales representative.

In cases where the application will demand a high level of reliability, such as automotive, medical instruments, public infrastructure, aerospace/ defense etc. Hirose must review before assurance of reliability can be given.