

DF53 Series

0.6mm Pitch, Small & Robust, Wire-to-Board Connector

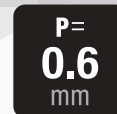

P= 0.6mm



Compact



Robust



Apr. 1. 2025 Copyright 2025 HIROSE ELECTRIC CO., LTD. All Rights Reserved.



Features

1. Compact and Low Profile Connector

Industry's smallest 0.6mm pitch crimp connector with 1.45mm height and 3.55mm depth

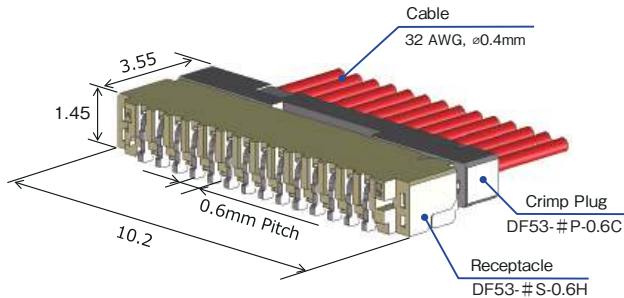

Occupied PCB Space : $3.55 \times 10.2 = 36.21\text{mm}^2$

2. Up to 1.3A Max. when using 2 positions for power.

0.6mm pitch connector that supports 32 AWG cable size. Can be used to supply power in compact devices.

3. Robust Design for Cable Wiring

The robust design secures high lance strength and prevents cable disconnect during wiring. The double lock design with friction lock and contact lock ensures high mating retention force. Prevents connector disconnect due to cable wiring.

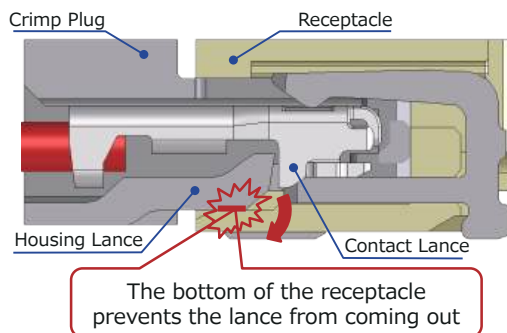

4. Box-shaped Contact Design

Use of a box-shaped contact on the cable side prevents deformation when handling the cable assembly.

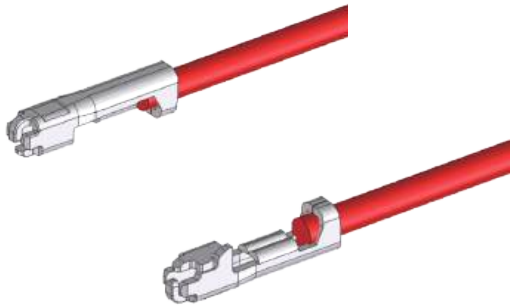

5. Prevents Incomplete Mating

During mating, part of the contact is visible from the crimp case slits, allowing for confirmation of the mating condition and preventing incomplete mating.

Half Mated

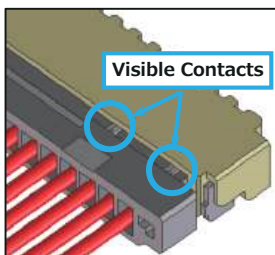

Contacts Visible Through Slits

Fully Mated

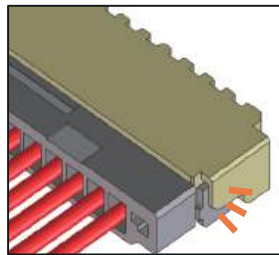

Contacts are No Longer Visible

6. Halogen Free

No chlorine or bromine above the standard value is used in the connector.

* Defined according to IEC 61249-2-21
 Br: 900ppm maximum, Cl: 900ppm maximum,
 Br+Cl: 1500ppm maximum

Product Specifications

Rated Current	When Using All Positions	When Using 2 Positions (Power)	Operating Temperature (Note 1)	-55 to +85°C
	0.7A	Power: 1.3A, Signal: 0.5A	Operating Humidity Range (Note 2)	20 to 80%
Rated Voltage	50V AC/DC		Storage Temperature Range (Note 3)	-10 to +60°C
			Storage Humidity Range (Note 2)(Note 3)	40 to 70%

Applicable Cable	Conductor Size: 32 AWG
------------------	------------------------

Item	Specifications	Conditions
Insulation Resistance	100M Ω Min.	100V DC
Withstanding Voltage	No flashover or insulation breakdown	200V AC for 1 min.
Contact Resistance	20m Ω Max.	20mV Max., 1mA (DC or 1000Hz)
Mating Durability	Contact Resistance: 40m Ω Max. No damage, cracks, or parts dislocation	20 times
Vibration Resistance	No electrical discontinuity of 1 μ s or more No damage, cracks, or parts dislocation	Frequency 10 to 55 Hz, half amplitude 0.75 mm, 10 times in each of the 3 directions
Shock	No electrical discontinuity of 1 μ s or more No damage, cracks, or parts dislocation	Accelerated velocity: 500 m/s ² for 11ms, half-sine wave in 3 directions, 3 times for each direction
Steady State Moisture Resistance	Contact resistance: 40m Ω Max. Insulation resistance: 100M Ω Min. No damage, cracks, or parts dislocation	96 hours at temperature of +40 \pm 2°C and humidity of 90 to 95%
Temperature Cycle	Contact resistance: 40m Ω Max. Insulation resistance: 100M Ω Min. No damage, cracks, or parts dislocation	Temperature: -55 \rightarrow +85°C Time: 30 \rightarrow 30 min. 5 cycles
Solder Heat Resistance	No melting of resin affecting product performance.	Reflow: See temperature profile

Note 1: Includes temperature rise caused by current flow.

Note 2: Use without condensation on parts.

Note 3: The term "storage" refers to products stored for long period of time prior to mounting and use. Operating Temperature and Humidity Range are applicable when non-powered after PCB mounting and when temporarily stored during transportation.

Materials / Finish

Item	Component	Materials	Color / Finish	UL Standard
Receptacle	Housing	Polyamide	Black	UL94V-0
	Contact	Copper Alloy	Tin Plating	-
	Retention Tab	Copper Alloy	Tin Plating	-
Crimp Plug	Housing	Polyamide	Black	UL94V-0
Crimp Contact	Contact	Copper Alloy	Tin Plating	-

Product Number Structure

Refer to the chart below when determining the product specifications from the product number.
Please select from the product numbers listed in this catalog when placing orders.

● Receptacle

DF53 - # S - 0.6 H

① ② ③ ④ ⑤

① Series Name	DF53	④ Contact Pitch	0.6mm
② No. of Pos.	2, 3, 4, 5, 6, 8, 10, 12, 14, 16, 18, 20	⑤ Terminal Style	H: SMT Right Angle Type
③ Connector Type	S: Receptacle		

● Crimp Plug

DF53 - # P - 0.6 C

① ② ③ ④ ⑤

① Series Name	DF53	④ Contact Pitch	0.6mm
② No. of Pos.	2, 3, 4, 5, 6, 8, 10, 12, 14, 16, 18, 20	⑤ Terminal Style	C: Crimp Case
③ Connector Type	P: Plug		

● Crimp Contact

DF53 - 32 PCF

① ② ③

① Series Name	DF53	③ Packaging Method/Type	PCF: Plug Crimp Contact, Reel, Tin Plating
② Applicable Wire Size	32 AWG		

Receptacle

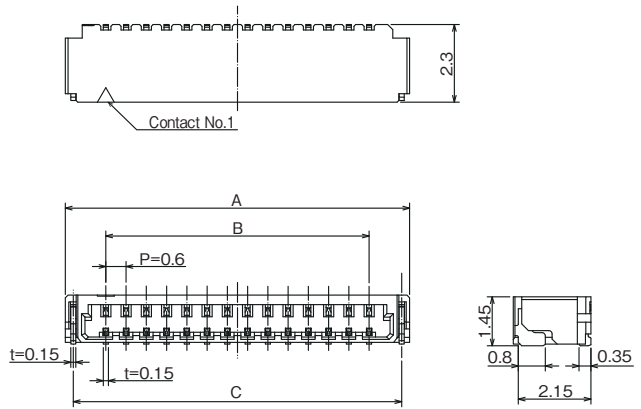

Recommended PCB Layout

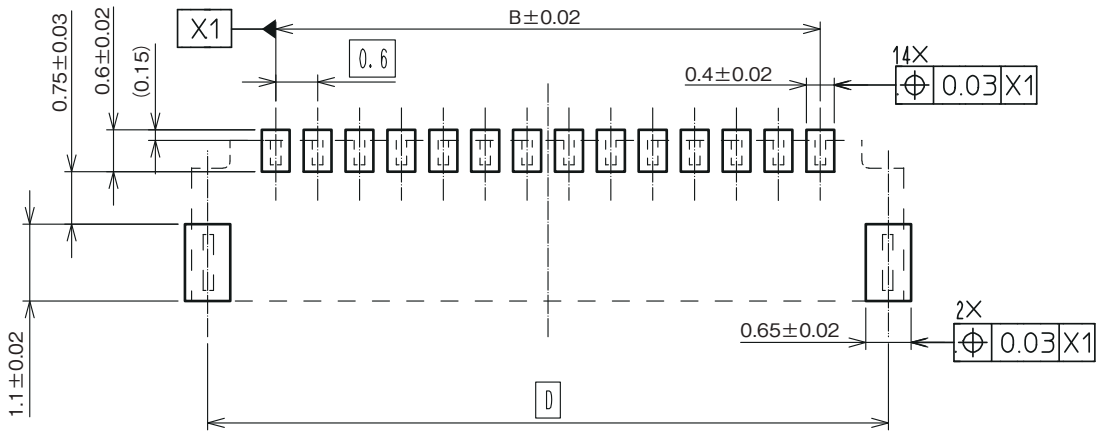

Recommended Metal Mask Dimensions

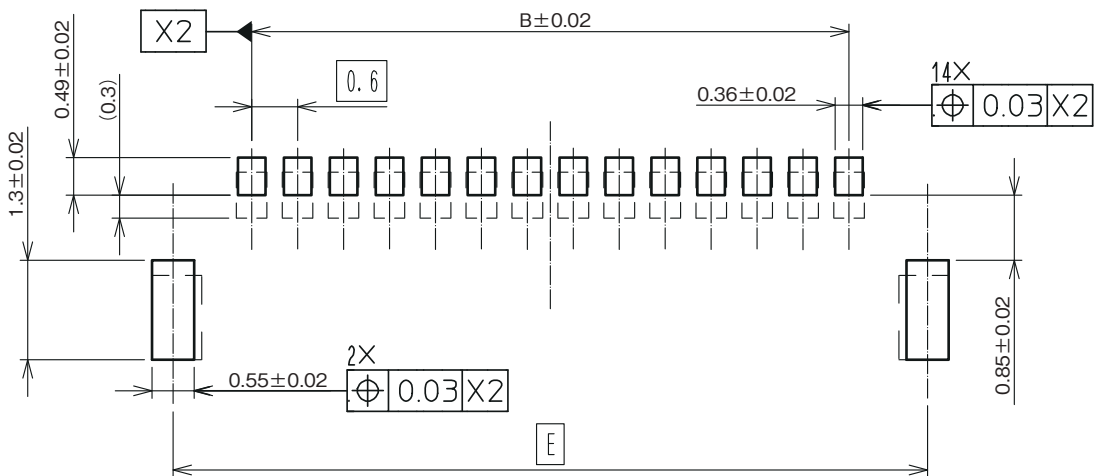

Recommended Metal Mask Thickness : 0.1mm

Unit : mm

Part No.	HRS No.	No. of Pos.	A	B	C	D	E	Purchase Unit
DF53-2S-0.6H	CL0668-1001-0-00	2	3.0	0.6	2.53	2.55	2.65	5,000pcs per reel
DF53-3S-0.6H	CL0668-1002-0-00	3	3.6	1.2	3.13	3.15	3.25	
DF53-4S-0.6H	CL0668-1003-0-00	4	4.2	1.8	3.73	3.75	3.85	
DF53-5S-0.6H	CL0668-1004-0-00	5	4.8	2.4	4.33	4.35	4.45	
DF53-6S-0.6H	CL0668-1005-0-00	6	5.4	3.0	4.93	4.95	5.05	
DF53-8S-0.6H	CL0668-1006-0-00	8	6.6	4.2	6.13	6.15	6.25	
DF53-10S-0.6H	CL0668-1007-0-00	10	7.8	5.4	7.33	7.35	7.45	
DF53-12S-0.6H	CL0668-1008-0-00	12	9.0	6.6	8.53	8.55	8.65	
DF53-14S-0.6H	CL0668-1009-0-00	14	10.2	7.8	9.73	9.75	9.85	
DF53-16S-0.6H	CL0668-1010-0-00	16	11.4	9.0	10.93	10.95	11.05	
DF53-18S-0.6H	CL0668-1011-0-00	18	12.6	10.2	12.13	12.15	12.25	
DF53-20S-0.6H	CL0668-1012-0-00	20	13.8	11.4	13.33	13.35	13.45	

Crimp Plug

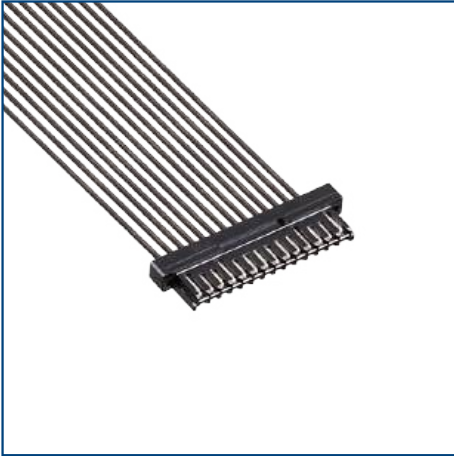

Shown with contacts installed.

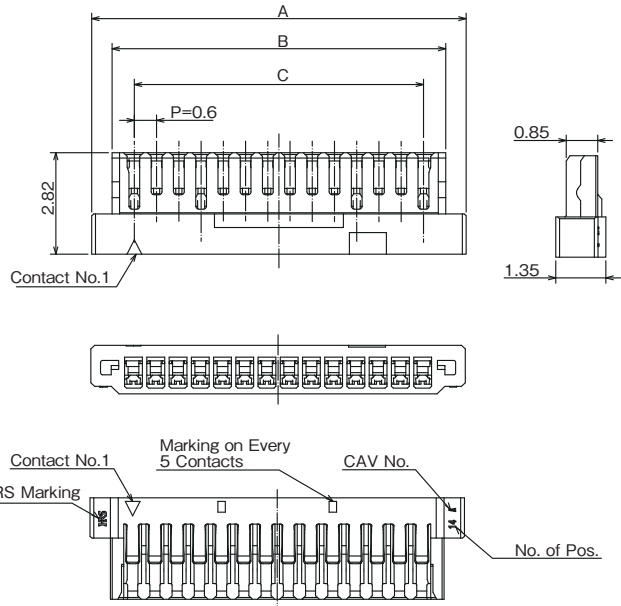

Unit : mm

Part No.	HRS No.	No. of Pos.	A	B	C	Purchase Unit
DF53-2P-0.6C	CL0668-1013-0-00	2	2.9	1.8	0.6	100pcs per bag
DF53-3P-0.6C	CL0668-1014-0-00	3	3.5	2.4	1.2	
DF53-4P-0.6C	CL0668-1015-0-00	4	4.1	3.0	1.8	
DF53-5P-0.6C	CL0668-1016-0-00	5	4.7	3.6	2.4	
DF53-6P-0.6C	CL0668-1017-0-00	6	5.3	4.2	3.0	
DF53-8P-0.6C	CL0668-1018-0-00	8	6.5	5.4	4.2	
DF53-10P-0.6C	CL0668-1019-0-00	10	7.7	6.6	5.4	
DF53-12P-0.6C	CL0668-1020-0-00	12	8.9	7.8	6.6	
DF53-14P-0.6C	CL0668-1021-0-00	14	10.1	9.0	7.8	
DF53-16P-0.6C	CL0668-1022-0-00	16	11.3	10.2	9.0	
DF53-18P-0.6C	CL0668-1023-0-00	18	12.5	11.4	10.2	
DF53-20P-0.6C	CL0668-1024-0-00	20	13.7	12.6	11.4	

Crimp Contact

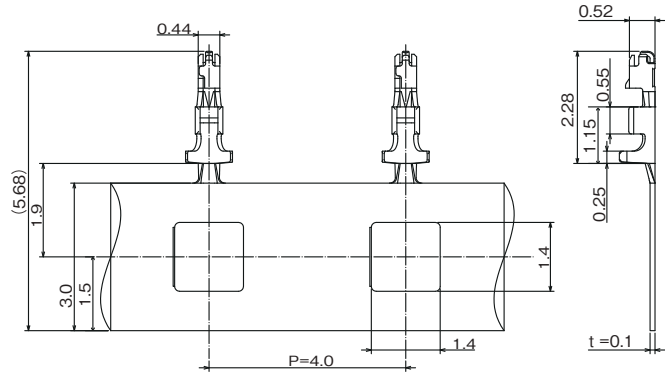
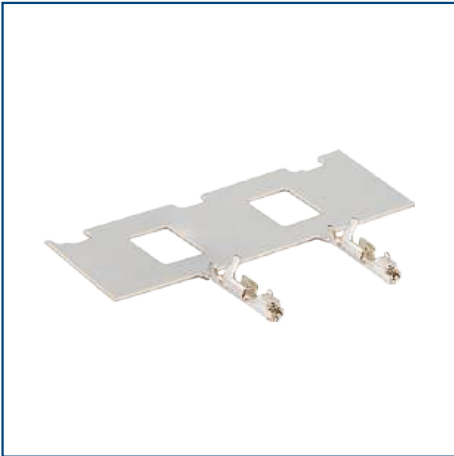

Unit : mm

Part No.	HRS No.	Purchase Unit
DF53-32PCF	CL0668-1025-0-00	40,000pcs per reel

● Applicable Wire (Tin Plated Annealed Copper)

Wire Size (Stranded Wire Structure)	Jacket Diameter	Recommended Wire	Strip Length
32 AWG (7/ ϕ 0.08)	ϕ 0.38	UL1867	0.8 to 1.0mm

Note 1: Refer to Crimp Condition when using cables other than applicable wire. Crimp Condition Table is available from Part No. link.
(If you are using a cable that is not listed in Crimp Condition Table, please contact a Hirose sales representative.)

Note 2: The strip length is for reference. Adjust each dimension after crimping so that the specified value is satisfied.
For details refer to the Crimp Quality Standard.

Packaging Method

Receptacle

- Embossed Carrier Tape Dimensions
(No of Pos.: 6, 8, 14)

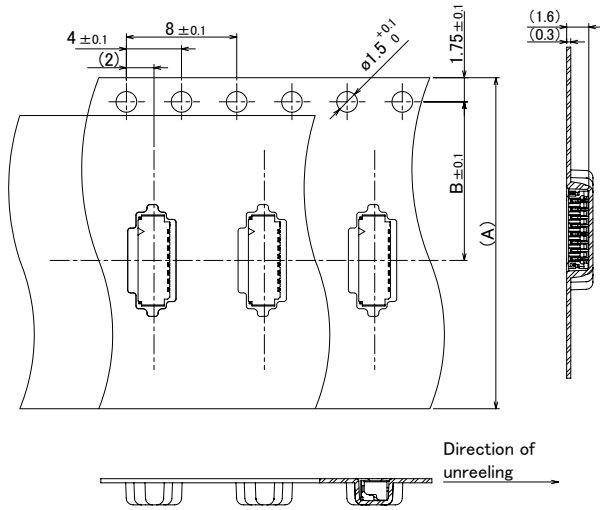

Receptacle

- Embossed Carrier Tape Dimensions
(No of Pos.: 2, 3, 4, 5, 10, 12, 16, 18, 20)

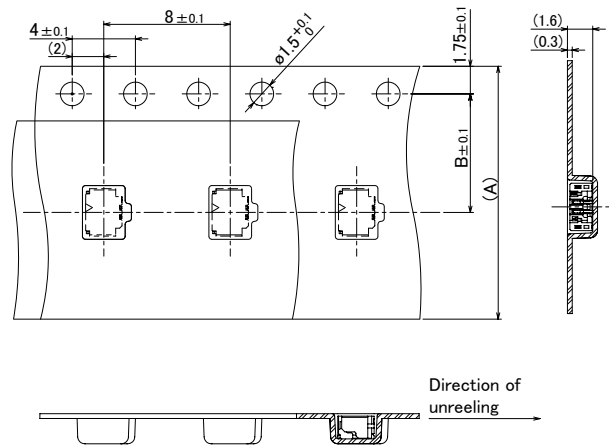

● Reel Dimensions

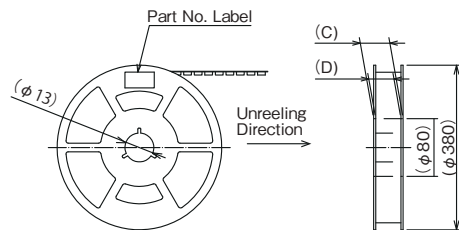

Unit : mm

Part No.	HRS No.	No. of Pos.	A	B	C	D	Purchase Unit
DF53-2S-0.6H	CL0668-1001-0-00	2	16.0	7.5	21.4	17.4	5,000pcs per reel
DF53-3S-0.6H	CL0668-1002-0-00	3	16.0	7.5	21.4	17.4	
DF53-4S-0.6H	CL0668-1003-0-00	4	16.0	7.5	21.4	17.4	
DF53-5S-0.6H	CL0668-1004-0-00	5	16.0	7.5	21.4	17.4	
DF53-6S-0.6H	CL0668-1005-0-00	6	16.0	7.5	21.4	17.4	
DF53-8S-0.6H	CL0668-1006-0-00	8	24.0	11.5	29.4	25.4	
DF53-10S-0.6H	CL0668-1007-0-00	10	24.0	11.5	29.4	25.4	
DF53-12S-0.6H	CL0668-1008-0-00	12	24.0	11.5	29.4	25.4	
DF53-14S-0.6H	CL0668-1009-0-00	14	24.0	11.5	29.4	25.4	
DF53-16S-0.6H	CL0668-1010-0-00	16	24.0	11.5	29.4	25.4	
DF53-18S-0.6H	CL0668-1011-0-00	18	24.0	11.5	29.4	25.4	
DF53-20S-0.6H	CL0668-1012-0-00	20	24.0	11.5	29.4	25.4	

Mated Dimensions

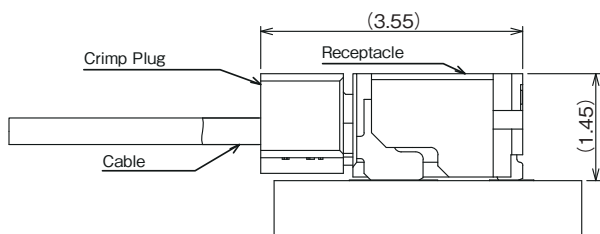

Applicable Tools

Type	Part No.	HRS No.	Applicable Contact
Automatic Crimp Press	CM-105C	CL0901-0001-0-00	-
Applicator (Note 1)	AP105-DF53-32P	CL0901-4657-0-00	DF53-32PCF
Extraction Tool	DF-C-PO(B)	CL0550-0179-2-00	

Note 1: This applicator is for fully automatic crimp machines that supply, strip and crimp the cable. It is not compatible with semi-automatic machines that require manual crimping of the cable.

Note 2: For details on the applicator, refer to the Tool Instruction Manual.

Note 3: Please conduct crimping work according to the Crimp Quality Standard and Crimp Condition.

Note 4: Any problems that occur from using tools other than those specified by Hirose are not covered by warranty.

Note 5: When non-authorized tools are used, please consult with a Hirose sales representative regarding requests for the hand tool die drawing.

Crimping Precautions

Items Required Prior to Crimping

The work-related documents shown below are required before starting the harness assembly.

(The ● mark represents required documents.)

Please contact your Hirose sales representative if you do not have these documents.

Document Title	Description	Automatic Crimping Machine	Remarks
① Main unit of crimping machine instruction manual	Explanation for main press machine unit	●	Bundled with the purchase of the main press machine unit.
② Applicator instruction manual	Crimping work method	●	Bundled with the purchase of applicator.
③ Applicator Spare Parts Identification	Explanation for Applicator installation	●	
④ Crimp Conditions	Standard values of: Crimp height Tensile strength	●	
⑤ Crimp Quality Standards	Various standards for crimping conditions	●	
⑥ Cable Assembly Instruction	Harness procedure	●	Please refer to our website.

Tools

- Use tools designated by Hirose when crimping.
- Crimping performed using tools other than those specified is outside the scope of warranty.
- The operating instructions are available for the crimping machine and the applicator. Be sure to carefully read the operating instructions manual before beginning work.

Applicable Cables

Check that the cables to be used are within the applicable range.

Refer to Crimp Condition when using cables other than applicable wire. Crimp Condition Table is available from Part No. link.

(If you are using a cable that is not listed in Crimp Condition Table, please contact a Hirose sales representative.)

[Precautions]

- Cables applicable to crimp connectors are tin-plated, soft copper stranded wires.
- Avoid crimping solid wire, wires with polyester threads or tin coated wires.
- Avoid crimping two cables together.
- The crimp height setting values (Note) may vary depending on the difference in the core wire configuration even if the computed cross-sectional area is the same.

Note: The crimp height is an important item that determines crimp quality. Hirose conducts crimp testing on each wire in order to set the optimum crimp height accurately.

Usage Precautions

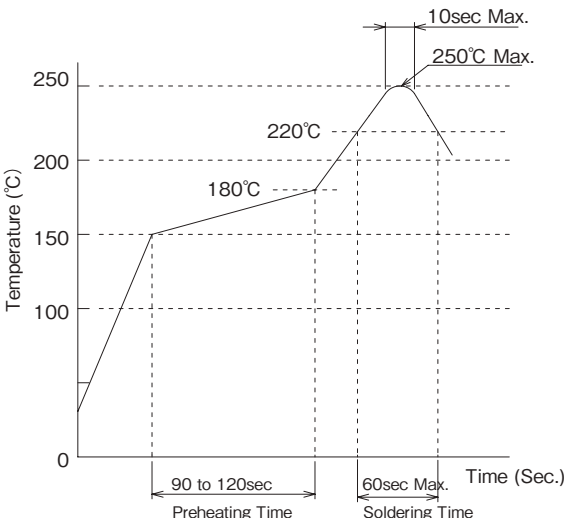
Temperature Profile	 <p> [Applicable Conditions] 1. Peak Temperature: 250°C Max. 2. Heating Area: 220°C Min., for less than 60 seconds 3. Preheating area: 150 to 180°C for 90 to 120 seconds 4. Number of Times: No more than 2 times </p> <p> Note: Measurement is conducted at the contact lead part Soldering results may change depending on conditions such as solder paste type, manufacturer, PCB size, and other soldering materials. Please determine all mounting conditions before use. </p>
Warpage of the Board	A maximum of 0.02mm at the center of connector, as measured from either end of the connector
Cleaning Conditions	IPA cleaning is allowed. (Cleaning is not recommended due to potential changes in mating action and other variables. Please contact us if you use other cleaning agents.)
Cautions	<ul style="list-style-type: none"> ■ Please note that any mating operation of the connector when not mounted on the board may cause damage or deformation of the contacts. ■ The housing color may have slight variations depending on the production lot. This color variation does not affect performance. ■ Please refer to "Product Guidelines (Mating/Unmating Operation Instruction Manual)" for handling points during mating.

While Taking into Consideration

Specifications mentioned in this catalog are reference values.

When considering to order or use this product, please review the Drawing and Product Specifications sheets.

Use an appropriate cable when using the connector in combination with cables.

If considering usage of a non-specified cable, please contact your sales representative.

If assembly process is done by jigs & tools which are not identified by Hirose, the warranty of the product may be affected.

If considering usage for below mentioned applications, please contact your sales representative.

In cases where the application will demand a high level of reliability, such as automotive, medical instruments, public infrastructure, aerospace/defense etc. Hirose must review before assurance of reliability can be given.