

Fig.1

■ Features

1. 5 Amps capacity

When used with 20 AWG wire, this connector has a maximum capacity of 5A.

(For rated current with other types of wires, please refer to the table on the next page)

2. Secure lock mechanism

Outer locking mechanism prevents accidental unmating due to external shocks or drops. (Fig.1)

3. Accurate board placement

Guide posts are used to help with board placement and prevent incorrect mating to the PCB.

4. Supports resin sealing

Accepts resin sealing up to 6.5mm without affecting the performance.

5. Short circuit prevention

The housing protects each contact by enclosing them in a "box" which also makes each contact independent of each other. This design prevents short circuits between adjacent contacts.

6. Excellent contact retention

A retainer is available to increase contact/cable retention and to assure complete contact insertion. The retainer should also be used when any mechanical stress could be applied to the cable.

7. Prevents solder cracking

To avoid solder crack, a glass-filled resin is used in the header housing to decrease thermal shrinkage.

8. Easy mating operation

A clear tactile click is delivered upon the completion of the mating process. This simplifies mating and increases work efficiency, especially when operating in a noisy environment.

Product Specifications

Ratings	Rated Current (Note 1)	No. of rows	No. of Contacts	20 AWG	22 AWG	Operating Temperature Range	-35 to +85°C (Note 2)
		1	2 to 6 contacts	5A/pin	5A/pin	Operating Humidity Range	40 to 80% (Note 3)
	2	4 to 12 contacts	5A/pin	4A/pin	Storage Temperature Range	-10 to +60°C (Note 4)	
	Rated Voltage	AC/DC 500V			Storage Humidity Range	40 to 70% (Note 4)	

Items	Specifications	Conditions
1. Contact Resistance	No more than 10mΩ (initially)	Measured at 20mV or below and 1mA
2. Insulation Resistance	No less than 1,000MΩ	Measured at DC 500V
3. Withstanding Voltage	No flashover or breakdown	Apply AC 1500V for one minute
4. Contact Insertion and Extraction Forces	0.5N Min, 4.5N Max	Measured with a □ 0.5 ±0.002 steel pin
5. Durability	Contact Resistance : no more than 20mΩ	30 mating cycles
6. Vibration Resistance	No electrical discontinuity of 1μs or greater	Frequency 10-55Hz, half amplitude 0.75mm, 3 directions, 10 times each
7. Shock Resistance	No electrical discontinuity of 1μs or greater	Acceleration : 490m/s ² , 11ms, Semi-sinusoidal 3 direction 3 times each.
8. Moisture-resistance	Contact Resistance : no more than 20mΩ Insulation Resistance : no less than 500MΩ	Left at temperature 40 ±2°C, humidity 90 to 95%, 96 hours
9. Temperature Cycles	Contact Resistance : no more than 20mΩ Insulation Resistance : no less than 1000MΩ	-55°C : 30 minutes → 85°C : 30 minutes 5 cycles
10. Soldering Heat Resistance	The resin parts should withstand the temperature and resist melting.	Flow : 260°C, 10 sec. Hand solder : Soldering iron temperature, 300°C, 3 sec.

Note 1 : This is the maximum current rating while all pins are powered or used as all power lines.

If you split the current over multiple lines, please factor in your own safety margin. Please contact Hirose Electric for inquiries on the assignment of pins and on the currents that can be delivered.

Note 2 : Includes temperature rise caused by current flow.

Note 3 : The connector should be completely dry. (no condensation present)

Note 4 : Applicable to unused items in packaged state.

Note 5 : Information contained in this catalog represents general requirements for this Series. Contact us for the drawings and specifications for a specific part number shown.

Materials / Finish

Product	Component	Materials	Finish	UL rating
Crimp socket	Insulator	PBT	White	UL94V-0
Crimp contact	Contact	Copper alloy	Tin plating	————
Pin header	Insulator	PBT	White	UL94V-0
	Contact	Brass	Tin plating	————
Retainer	Insulator	PBT	Black	UL94V-0

Product Number Structure

●Connector

DF33C – 2 S – 3.3 C

① ② ③ ④ ⑤

●Contact

DF33A – 2022 SCF

⑥ ⑦

① Series Name : DF33C	④ Contact pitch : 3.3 mm
② No. of contacts : 2 to 6 (single row product) : 4 to 12 (double row product)	⑤ Termination/terminal shape C : Crimp housing DSA : Straight pin header Blank : Retainer
③ Connector type S : Single row socket DS : Double row socket P : Single row pin header DP : Double row pin header RS : Single row retainer RDS : Double row retainer	⑥ Applicable wire size 2022 : 20 to 22 AWG
	⑦ Packing type SCF : Socket contact / reel SC : Socket contact / pack

Single row straight pin header

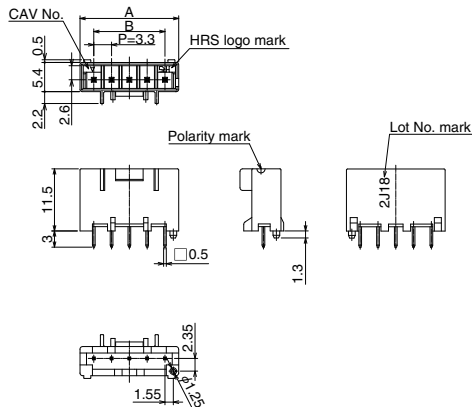

Standard type (Resin: White)

Unit : mm

Part No.	HRS No.	No. of Contacts	A	B	Packing
DF33C-2P-3.3DSA(24)	676-1131-2 24	2	8.4	3.3	135pcs/tray
DF33C-3P-3.3DSA(24)	676-1132-5 24	3	11.7	6.6	95pcs/tray
DF33C-4P-3.3DSA(24)	676-1133-8 24	4	15.0	9.9	75pcs/tray
DF33C-5P-3.3DSA(24)	676-1134-0 24	5	18.3	13.2	60pcs/tray
DF33C-6P-3.3DSA(24)	676-1135-3 24	6	21.6	16.5	50pcs/tray

[Specification No.]
(24): Tin plating, tray package specification

Recommended PCB layout (Recommended PCB thickness t=1.6 ±0.1)

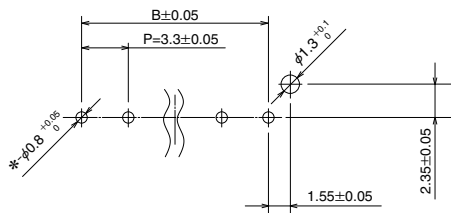

Dimensions in mated condition Application figure

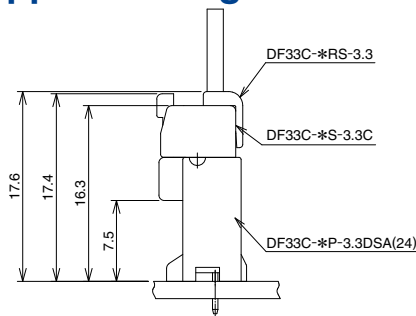

Double row, straight pin header

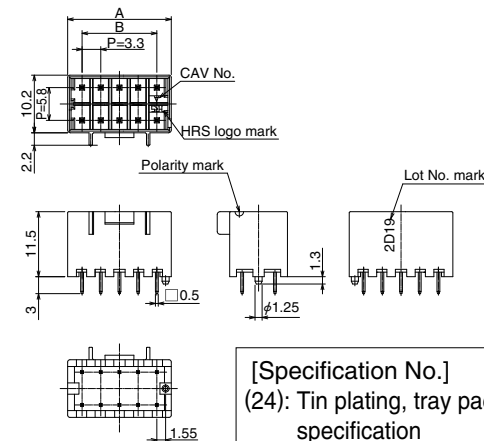
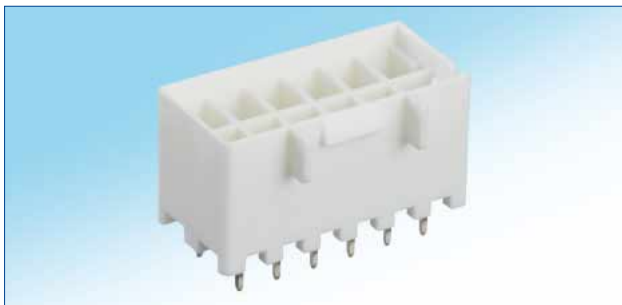

Standard type (Resin color: White)

Unit : mm

Part No.	HRS No.	No. of Contacts	A	B	Packing
DF33C-4DP-3.3DSA(24)	676-1113-0 24	4	8.4	3.3	135pcs/tray
DF33C-6DP-3.3DSA(24)	676-1114-3 24	6	11.7	6.6	95pcs/tray
DF33C-8DP-3.3DSA(24)	676-1115-6 24	8	15.0	9.9	75pcs/tray
DF33C-10DP-3.3DSA(24)	676-1116-9 24	10	18.3	13.2	60pcs/tray
DF33C-12DP-3.3DSA(24)	676-1117-1 24	12	21.6	16.5	50pcs/tray

[Specification No.]
(24): Tin plating, tray package specification

Recommended PCB layout (Recommended PCB thickness t=1.6 ±0.1)

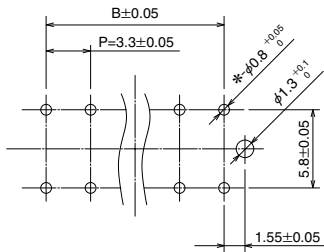

Application figure

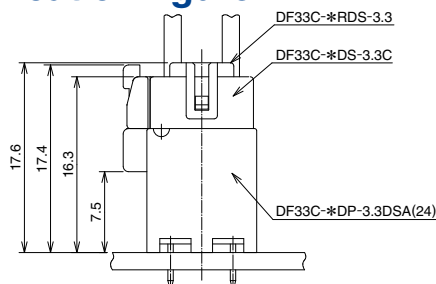

Single row socket

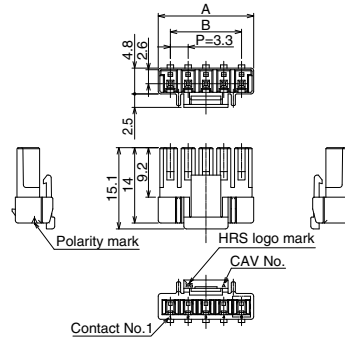

Standard type (Resin color: White)

Unit : mm

Part No.	HRS No.	No.of Contacts	A	B	Packing
DF33C-2S-3.3C	676-1136-6 00	2	7.8	3.3	100pcs/ pack
DF33C-3S-3.3C	676-1137-9 00	3	11.1	6.6	
DF33C-4S-3.3C	676-1138-1 00	4	14.4	9.9	
DF33C-5S-3.3C	676-1139-4 00	5	17.7	13.2	
DF33C-6S-3.3C	676-1140-3 00	6	21.0	16.5	

*For the retainers, please refer to page 5.

Double row socket

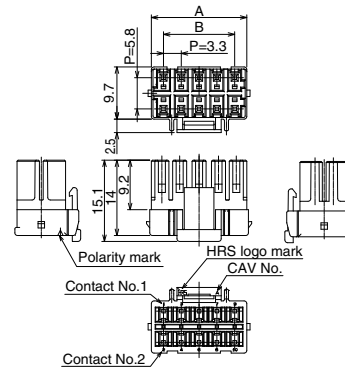
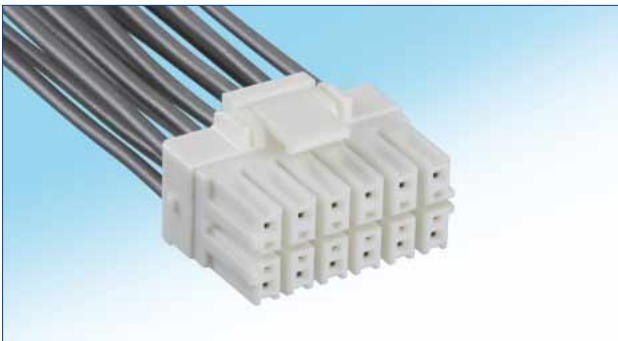

Standard type (Resin color: White)

Unit : mm

Part No.	HRS No.	No.of Contacts	A	B	Packing
DF33C-4DS-3.3C	676-1119-7 00	4	7.8	3.3	100pcs/ pack
DF33C-6DS-3.3C	676-1120-6 00	6	11.1	6.6	
DF33C-8DS-3.3C	676-1121-9 00	8	14.4	9.9	
DF33C-10DS-3.3C	676-1122-1 00	10	17.7	13.2	
DF33C-12DS-3.3C	676-1123-4 00	12	21.0	16.5	

*For the retainers, please refer to page 5.

Single row retainer

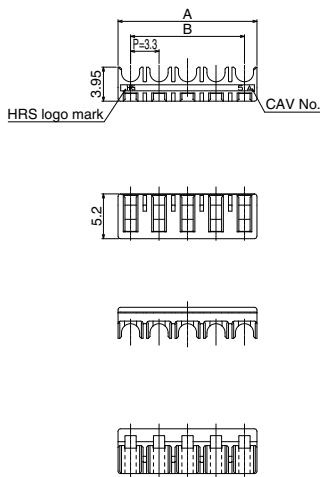

Unit : mm

Part No.	HRS No.	No.of Contacts	A	B	Packing
DF33C-2RS-3.3	676-1141-6 00	2	6.2	3.3	100pcs/ pack
DF33C-3RS-3.3	676-1142-9 00	3	9.5	6.6	
DF33C-4RS-3.3	676-1143-1 00	4	12.8	9.9	
DF33C-5RS-3.3	676-1144-4 00	5	16.1	13.2	
DF33C-6RS-3.3	676-1145-7 00	6	19.4	16.5	

Double row retainer

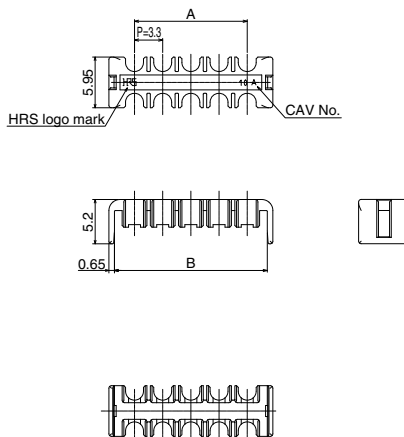

Unit : mm

Part No.	HRS No.	No.of Contacts	A	B	Packing
DF33C-4RDS-3.3	676-1125-0 00	4	3.3	8.0	100pcs/ pack
DF33C-6RDS-3.3	676-1126-2 00	6	6.6	11.3	
DF33C-8RDS-3.3	676-1127-5 00	8	9.9	14.6	
DF33C-10RDS-3.3	676-1128-8 00	10	13.2	17.9	
DF33C-12RDS-3.3	676-1129-0 00	12	16.5	21.2	

Socket crimp contact

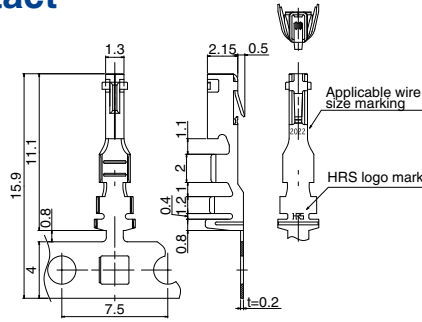

Part No.	HRS No.	Applicable cable				Packaging	Finish
		Style	Jacket diameter	Wire size	Stranded wire conductor		
DF33A-2022SCF	676-1093-5 00	1007	φ1.5 to 1.9mm	22 AWG	17/0.16mm	10,000 /reel	Tin plated
				20 AWG	21/0.18mm		
DF33A-2022SC	676-1094-8	1007	φ1.7mm	22 AWG	17/0.06mm	100 /pack	
			φ1.8mm	20 AWG	21/0.18mm		

Note 1 : Applicable wire with tin plated solid soft conductor.

Note 2 : When using other than the recommended wire, contact your nearest Hirose representative.

Strip length: 2.7 to 3.5mm

Applicable crimp tool

Type	Part No.	HRS No.	Applicable Contact
Applicator	AP105-DF33-2022S	901-4603-0 00	DF33A-2022SCF
	CHS893300H-UP(Note 3)	-	
Press main body	CM-105C	901-0001-0 00	-
Hand tool	HT304/DF33-2022S	550-0300-1	DF33A-2022SC
Contact unmating tool	DF33-C-PO	902-4551-2 00	DF33A-2022SCF DF33A-2022SC

Note 1 : Hirose does not guarantee products that have been damaged from the use of inapplicable tools

Note 2 : Please do the crimping operations according to the "Crimping quality standard" and "Crimp condition".

Note 3 : Applicator manufactured by JAPAN AUTOMATIC MACHINE (J.A.M.). Please access to HP of J.A.M., if you make inquiries about the applicator or crimp defect. (URL : <http://www.jam-net.co.jp>)

Unmating Procedure

- Contact unmating tool: DF33-C-PO
- Applicable contact: DF33A-2022SCF, DF33A-2022SC
- Operation method (Example) DF33C-*S-3.3C, DF33A-2022SCF

Housing cross-section figure

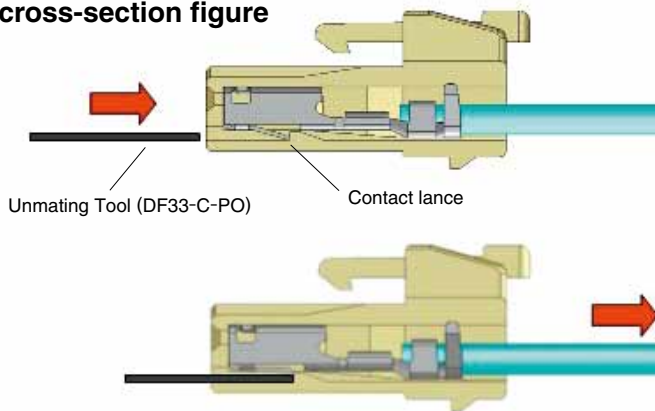

1. Insert the unmating tool and move or disengage the contact lance. (as shown in the example on the left)

2. Make sure that the lance has moved sufficiently enough to allow the terminated wire to be removed easily.

Note : Lance strength may have decreased due to the repair work. It is recommended to use new crimp terminals instead of reusing repaired crimp terminals. The case can be reused.

Caution

There are parts on the crimp contact that can cause injuries, please use caution when unmating the contacts.

◆ Operating Precautions

- These connectors can become damaged if excessive force is applied during extraction. If you experience difficulty when unmating this connector, gently push it further into the housing and then operate the lock and release the connector.
- When performing a resin sealing, pay attention to the surface tension of the resin and fill accordingly.
- Wire routing inside the device can cause added tension to be applied to the contacts. Use of a retainer will help remedy the stress placed on the contact.
- Prior to reusing a terminated wire, make sure that the contact's lance is raised to the proper height.
- There may be a slight variance in the color of the molding between production lots, this variance will not affect the performance of the connector.
- Black spots may appear on the mold resin but this does not affect the product quality.
- Please refer to the documents "Cable assembly Procedure", "Crimp condition" and "Crimp quality standards" for the cable assembly procedures.
- Please refer to the "Nylon Connector Guide" for handling instructions.

◆ Ratings

If the connector is rated at 3A, and the wire used with the connector only has a 1A capacity, the connection will be regarded as a 1A connection. Please make sure that you do not place too much current through this connector. Even though the connector may be rated to take the current applied to it, currents are not always distributed equally due to the differences in wiring path or contact resistance. Due to this precaution, the current may exceed the ratings previously discussed. In these cases, use 1/3 of the noted rating as the maximum. Do not mate/unmate this connector when energized with a live current

(Note 1) "Live" mating and unmating is defined as "to conduct the mating and unmating process while the system is conducting electricity"

◆ Usage Under Harsh Environments

When using these connectors in a harsh environment such as one with repeated high and low temperatures, please contact us for advice.

MEMO :

A series of horizontal dashed lines for writing a memo.

Aug. 1.2024 Copyright 2024 HIROSE ELECTRIC CO., LTD. All Rights Reserved.