

May.1.2022 Copyright 2022 HIROSE ELECTRIC CO., LTD. All Rights Reserved.
 In case of consideration for using Automotive equipment / device which demand high reliability, kindly contact our sales window correspondents.

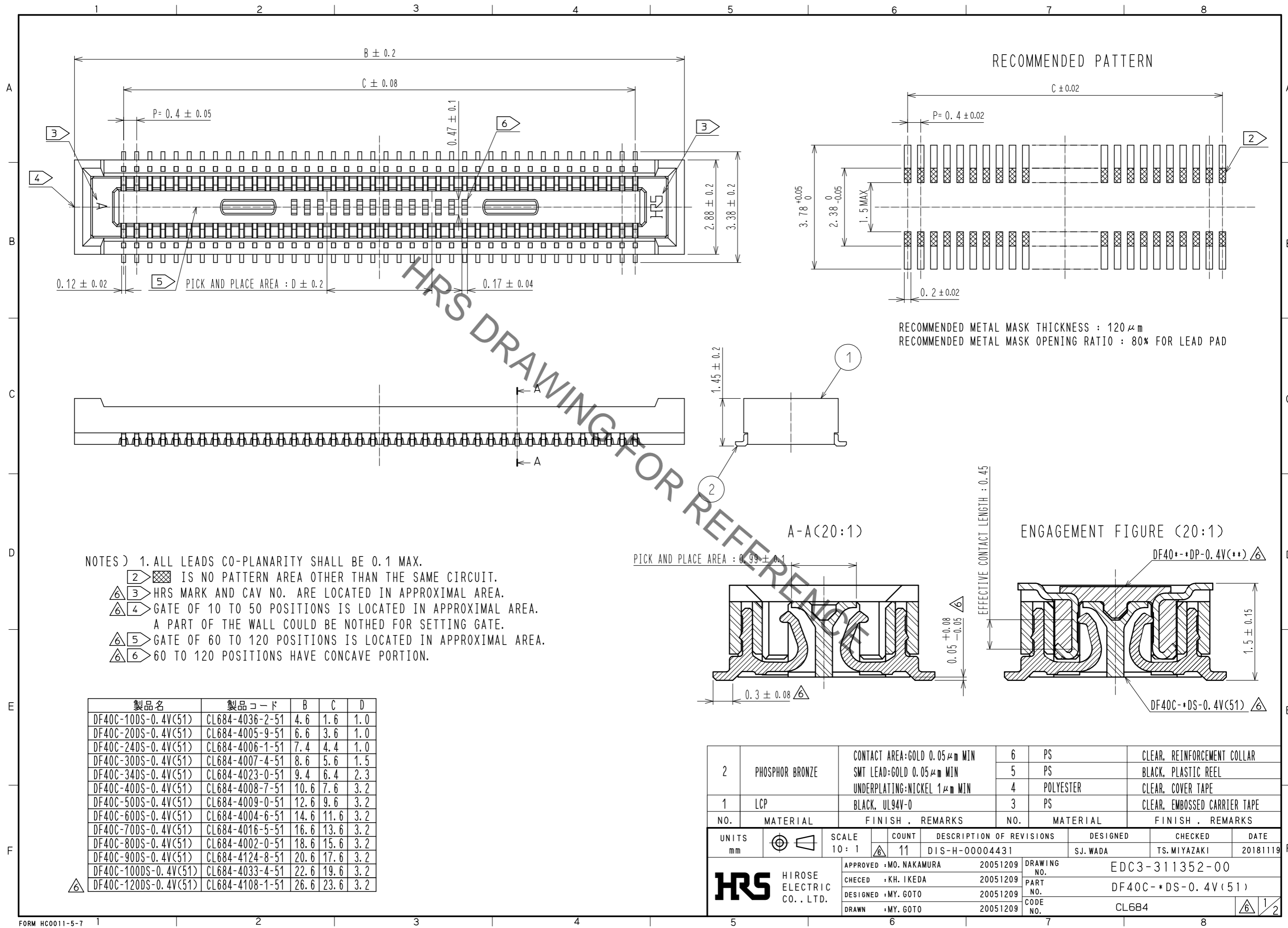

製品名	製品コード	B	C	D
DF40C-10DS-0.4V(51)	CL684-4036-2-51	4.6	1.6	1.0
DF40C-20DS-0.4V(51)	CL684-4005-9-51	6.6	3.6	1.0
DF40C-24DS-0.4V(51)	CL684-4006-1-51	7.4	4.4	1.0
DF40C-30DS-0.4V(51)	CL684-4007-4-51	8.6	5.6	1.5
DF40C-34DS-0.4V(51)	CL684-4023-0-51	9.4	6.4	2.3
DF40C-40DS-0.4V(51)	CL684-4008-7-51	10.6	7.6	3.2
DF40C-50DS-0.4V(51)	CL684-4009-0-51	12.6	9.6	3.2
DF40C-60DS-0.4V(51)	CL684-4004-6-51	14.6	11.6	3.2
DF40C-70DS-0.4V(51)	CL684-4016-5-51	16.6	13.6	3.2
DF40C-80DS-0.4V(51)	CL684-4002-0-51	18.6	15.6	3.2
DF40C-90DS-0.4V(51)	CL684-4124-8-51	20.6	17.6	3.2
DF40C-100DS-0.4V(51)	CL684-4033-4-51	22.6	19.6	3.2
DF40C-120DS-0.4V(51)	CL684-4108-1-51	26.6	23.6	3.2

NO.	MATERIAL	FINISH	REMARKS	NO.	MATERIAL	FINISH	REMARKS
2	PHOSPHOR BRONZE		CONTACT AREA:GOLD 0.05 μm MIN SMT LEAD:GOLD 0.05 μm MIN UNDERPLATING:NICKEL 1 μm MIN	6	PS		CLEAR, REINFORCEMENT COLLAR
				5	PS		BLACK, PLASTIC REEL
				4	POLYESTER		CLEAR, COVER TAPE
1	LCP		BLACK, UL94V-0	3	PS		CLEAR, EMBOSSED CARRIER TAPE

UNITS	SCALE	COUNT	DESCRIPTION OF REVISIONS	DESIGNED	CHECKED	DATE
mm	10:1	11	DIS-H-00004431	SJ.WADA	TS.MIYAZAKI	20181119

APPROVED	CHECKED	DESIGNED	DRAWN	DRAWING NO.	PART NO.	CODE NO.
MO.NAKAMURA	KH.IKEDA	MY.GOTO	MY.GOTO	EDC3-311352-00	DF40C-*DS-0.4V(51)	CL684

May.1.2022 Copyright 2022 HIROSE ELECTRIC CO., LTD. All Rights Reserved.
 In case of consideration for using Automotive equipment / device which demand high reliability, kindly contact our sales window correspondents.

EMBOSSED CARRIER TAPE PACKAGING (5:1)

STYLE AND DIMENSION OF REEL(FREE SIZE)

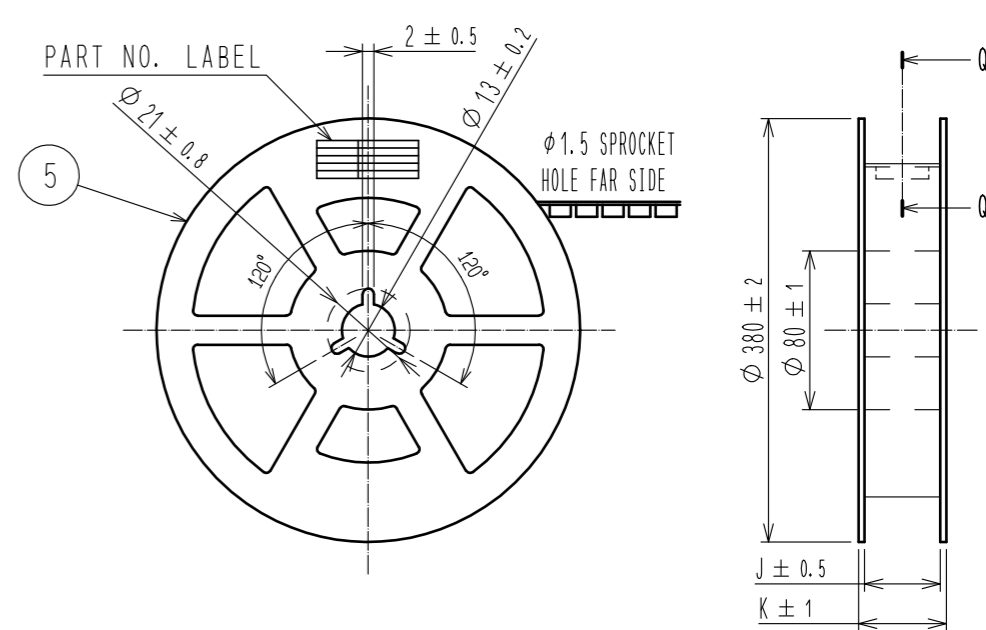
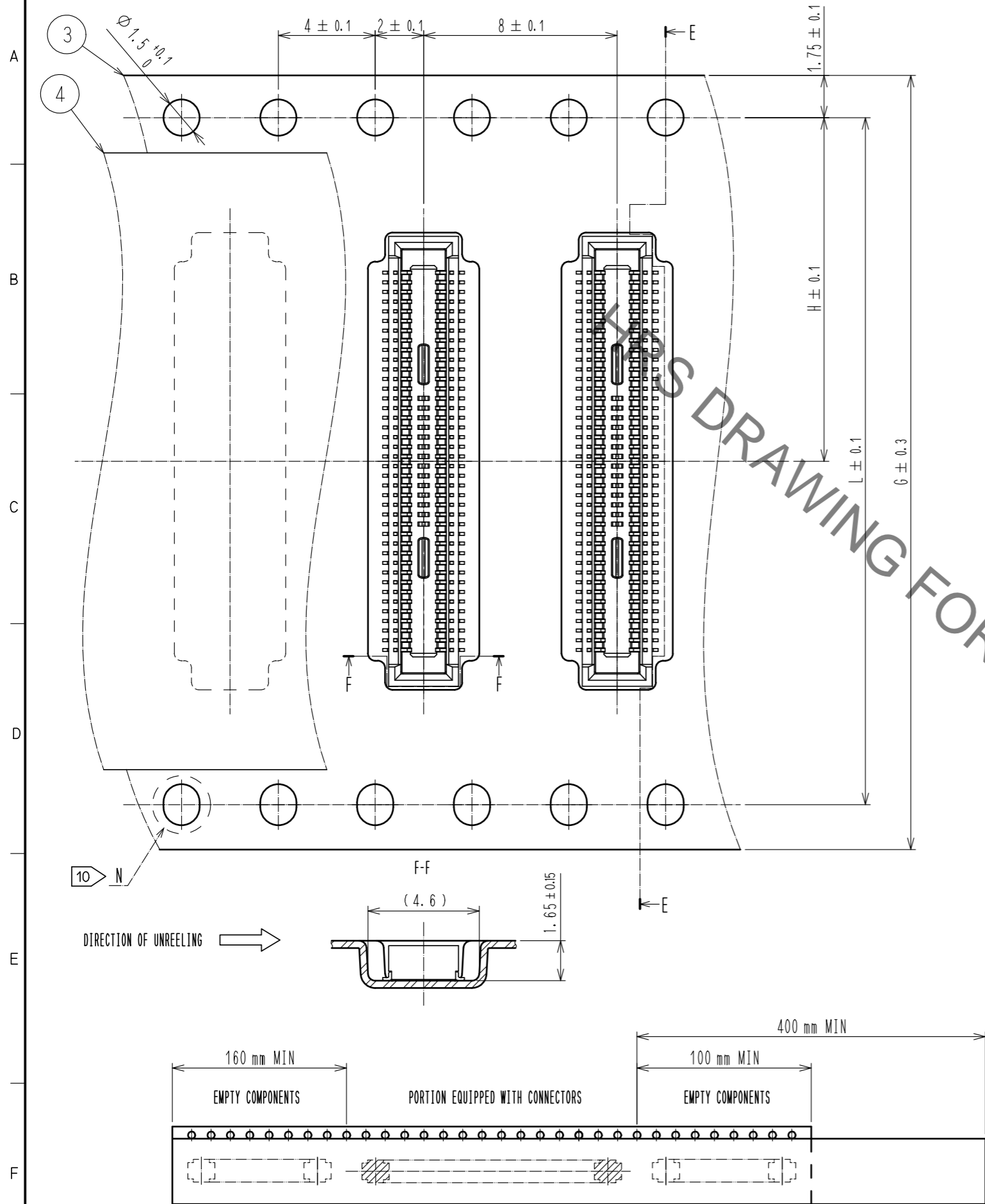

DETAIL OF PART NO. LABEL

製造年月日	** ** *	DATE OF MANUFACTURED
製品コード	CL684-****-51	CODE NO.
製品名	DF40C-*DS-0.4V(51)	PART NO.
数量	5000	QUANTITY
納入者	ヒロセ電機(株)	SUPPLIER

PART NO.	G	H	J	K	L	M
DF40C-10DS-0.4V(51)	16	7.5	17.5	21.5	—	4.9
DF40C-20DS-0.4V(51)	16	7.5	17.5	21.5	—	6.9
DF40C-24DS-0.4V(51)	16	7.5	17.5	21.5	—	7.7
DF40C-30DS-0.4V(51)	24	11.5	25.5	29.5	—	8.9
DF40C-34DS-0.4V(51)	24	11.5	25.5	29.5	—	8.9
DF40C-40DS-0.4V(51)	24	11.5	25.5	29.5	—	10.9
DF40C-50DS-0.4V(51)	24	11.5	25.5	29.5	—	12.9
DF40C-60DS-0.4V(51)	24	11.5	25.5	29.5	—	14.9
DF40C-70DS-0.4V(51)	32	14.2	33.5	37.5	28.4	16.9
DF40C-80DS-0.4V(51)	32	14.2	33.5	37.5	28.4	18.9
DF40C-90DS-0.4V(51)	44	20.2	45.5	49.5	40.4	20.9
DF40C-100DS-0.4V(51)	44	20.2	45.5	49.5	40.4	22.9
DF40C-120DS-0.4V(51)	44	20.2	45.5	49.5	40.4	26.9

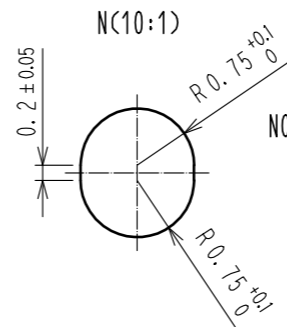

- NOTES)
- 7. PER REEL 5000 CONNECTORS.
 - 8. THE DIMENSIONS IN PARENTHESES ARE FOR REFERENCE.
 - 9 REFER TO JIS C 0806(IEC 60286-3)(PACKING OF COMPONENTS FOR AUTOMATIC HANDLING)
 - 10 TO 60 POSITIONS EMBOSSED CARRIER TAPE HAS THE SPROCKET HOLE ON ONE SIDES.
 - 11 AFTER PACKAGING, ROLL 2 METERS OF THE REINFORCEMENT COLLAR TO OUTER CIRCUMFERENCE OF TAPE AND REEL POCKET, AND TAPE DOWN AT THE END THE COLLAR.

HRS	DRAWING NO.	EDC3-311352-00
	PART NO.	DF40C-*DS-0.4V(51)
	CODE NO.	CL684
		2/2