

Feb.1.2021 Copyright 2021 HIROSE ELECTRIC CO., LTD. All Rights Reserved.
In case of consideration for using Automotive equipment / device which demand high reliability, kindly contact our sales window correspondents.

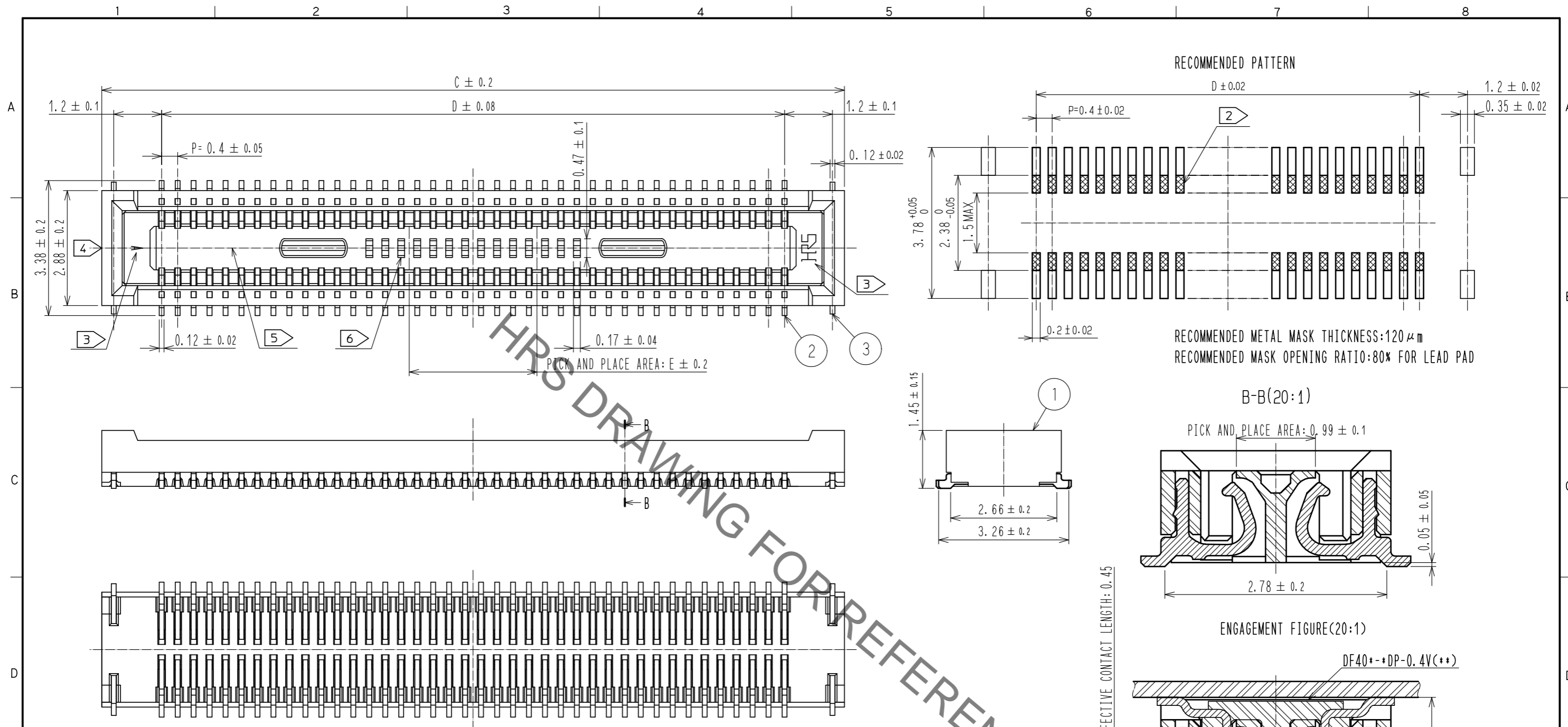

- NOTES) 1. ALL LEADS AND REINFORCED METAL FITTINGS CO-PLANARITY SHALL BE 0.1mm MAX.
- ② IS NO PATTERN AREA OTHER THAN THE SAME CIRCUIT.
 - ③ HRS MARK AND CAV NO. IS INDICATED IN APPROXIMAL POSITION SHOWN.
 - ④ GATE POSITION OF 10 TO 50 POSITIONS IS POSITIONED IN APPROXIMAL AREA SHOWN.
 - ⑤ GATE POSITION OF 60 TO 100 POSITIONS IS POSITIONED IN APPROXIMAL AREA SHOWN.
A PART OF THE WALL COULD BE NOTCHED FOR SETTING GATE.
 - ⑥ 60 TO 100 POSITIONS HAVE CONCAVE PORTION.

製品名	製品コード	C	D	E
DF40B-10DS-0.4V(51)	CL684-4038-8-51	4.6	1.6	1.0
DF40B-12DS-0.4V(51)	CL684-4152-3-51	5.0	2.0	1.0
DF40B-20DS-0.4V(51)	—	6.6	3.6	1.0
DF40B-24DS-0.4V(51)	—	7.4	4.4	1.0
DF40B-30DS-0.4V(51)	CL684-4090-8-51	8.6	5.6	1.5
DF40B-40DS-0.4V(51)	—	10.6	7.6	3.2
DF40B-50DS-0.4V(51)	CL684-4018-0-51	12.6	9.6	3.2
DF40B-60DS-0.4V(51)	CL684-4049-4-51	14.6	11.6	3.2
DF40B-80DS-0.4V(51)	CL684-4052-9-51	18.6	15.6	3.2
DF40B-100DS-0.4V(51)	—	22.6	19.6	3.2

NO.	MATERIAL	FINISH . REMARKS	NO.	MATERIAL	FINISH . REMARKS
2	PHOSPHOR BRONZE	CONTACT AREA:GOLD 0.05 μm MIN SMT LEAD:GOLD 0.05 μm MIN UNDERPLATING:NICKEL 1 μm MIN	7	PS	CLEAR, REINFORCEMENT COLLAR
1	LCP	BLACK, UL94V-0	6	PS	BLACK
			5	POLYESTER	CLEAR, COVER TAPE
			4	PS	CLEAR, EMBOSSED CARRIER TAPE
			3	PHOSPHOR BRONZE	GOLD 0.05 μm MIN UNDERPLATING:NICKEL 1 μm MIN

UNITS	SCALE	COUNT	DESCRIPTION OF REVISIONS	DESIGNED	CHECKED	DATE
mm	10 : 1	2	DIS-H-00002752	SH. HOSODA	TS. MIYAZAKI	17. 10. 10

APPROVED	CHECKED	DESIGNED	DRAWN	DRAWING NO.	PART NO.	CODE NO.
KH. IKEDA	AR. TAKAHASHI	TK. SUZUKI	TK. SUZUKI	EDC3-316871-01	DF40B-*DS-0.4V(51)	CL684
07. 08. 31	07. 08. 31	07. 08. 31	07. 08. 31			

Feb.1.2021 Copyright 2021 HIROSE ELECTRIC CO., LTD. All Rights Reserved.
In case of consideration for using Automotive equipment / device which demand high reliability, kindly contact our sales window correspondents.

EMBOSSED CARRIER TAPE PACKAGING (5:1)

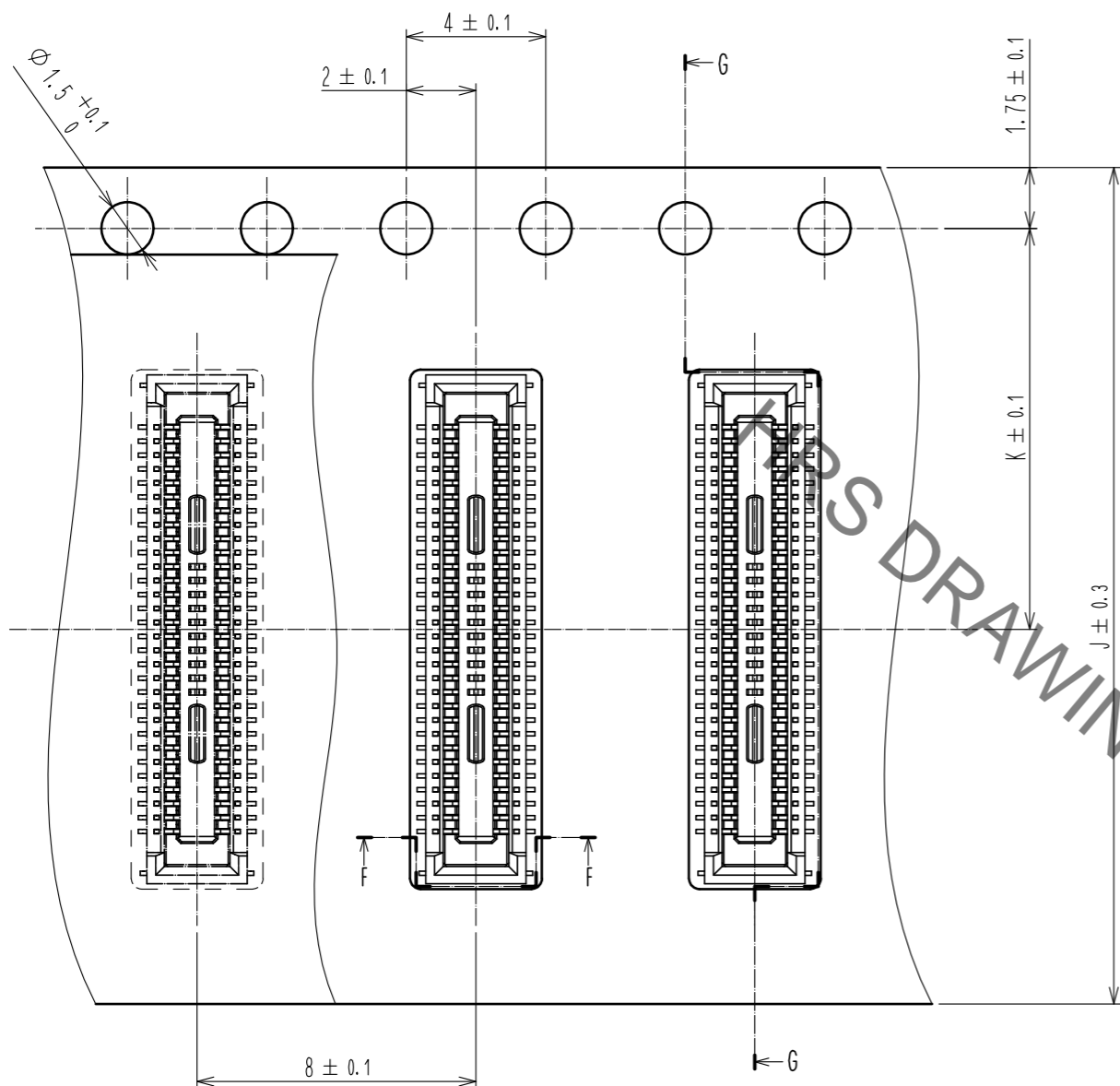

DIRECTION OF UNREELING →

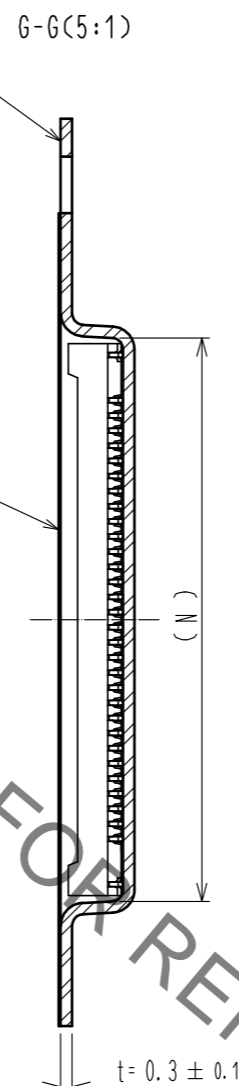
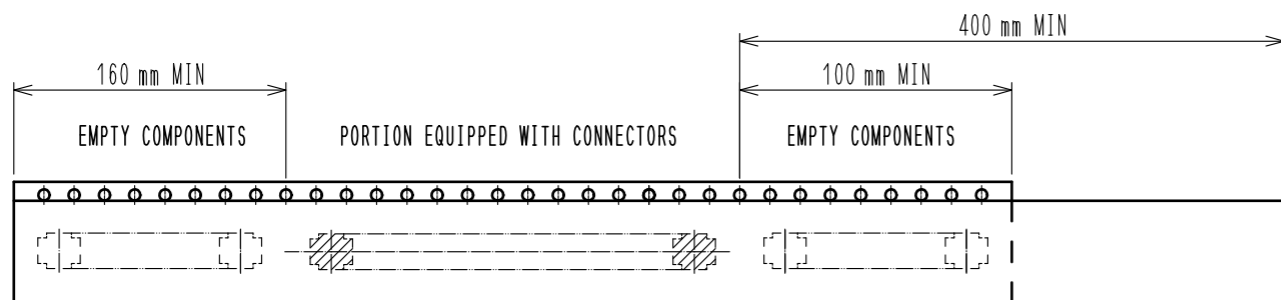
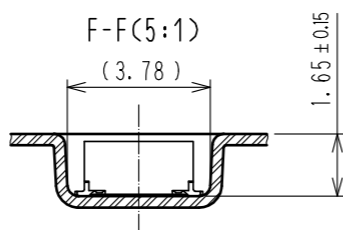

STYLE AND DIMENSION OF REEL(FREE)

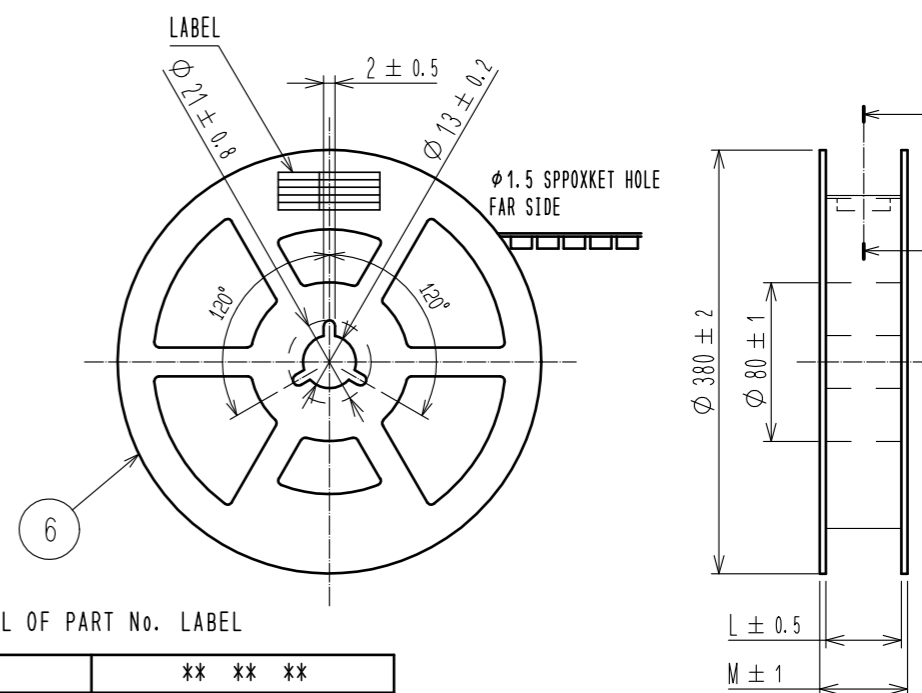

10) DETAIL OF PART No. LABEL

製造年月日	** ** *
製品コード	CL684-*****-51
製品名	DF40B-*DS-0.4V(51)
数量	5000
納入者	ヒロセ電機(株)

製品名	J	K	L	M	N
DF40B-10DS-0.4V(51)	16	7.5	17.5	21.5	2.9
DF40B-12DS-0.4V(51)	16	7.5	17.5	21.5	3.3
DF40B-20DS-0.4V(51)	16	7.5	17.5	21.5	4.9
DF40B-24DS-0.4V(51)	16	7.5	17.5	21.5	6.9
DF40B-30DS-0.4V(51)	24	11.5	25.5	29.5	8.9
DF40B-40DS-0.4V(51)	24	11.5	25.5	29.5	10.9
DF40B-50DS-0.4V(51)	24	11.5	25.5	29.5	12.9
DF40B-60DS-0.4V(51)	24	11.5	25.5	29.5	14.9
DF40B-80DS-0.4V(51)	32	14.2	33.5	37.5	18.9
DF40B-100DS-0.4V(51)	44	20.2	45.5	49.5	22.9

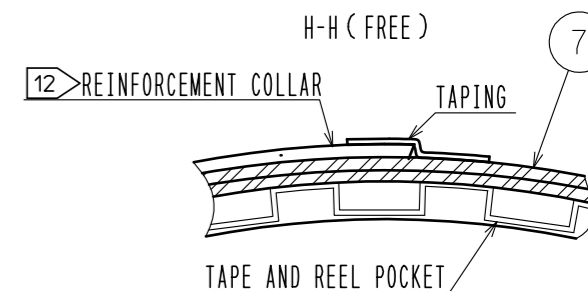

NOTES 7. PER REEL 5000 CONNECTORS.

8. THE DIMENSIONS IN PARENTHESES ARE FOR REFERENCE.
- 9) REFER TO JIS C 0806(IEC 60286-3)(PACKING OF COMPONENTS FOR AUTOMATIC HANDLING)
- 10) DETAIL OF PART No. LABEL IS WRITTEN IN JAPANESE.
PART NO. LABEL DESCRIBES THE FOLLOWING INFORMATION FROM TOP.
PRODUCTION DATE:
PRODUCT CODE: CL684-*****-51
PART NUMBER: DF40B-*DS-0.4V(51)
NUMBER OF PIECES: 5000 PIECES
SUPPLIER NAME: HIROSE ELECTRIC CO., LTD.
11. 80 TO 100 POSITIONS EMBOSSED CARRIER TAPE HAS THE SPROCKET HOLE ON BOTH SIDES.
- 12) AFTER PACKAGING, ROLL 2 METERS OF THE REINFORCEMENT COLLAR TO OUTER CIRCUMFERENCE OF TAPE AND REEL POCKET, AND TAPE DOWN AT THE END THE COLLAR.

HRS	DRAWING NO.	EDC3-316871-01
	PART NO.	DF40B-*DS-0.4V(51)
	CODE NO.	CL684