

Apr.1.2026 Copyright 2026 HIROSE ELECTRIC CO., LTD. All Rights Reserved.  
 本製品を車載用途などの高い信頼性が求められる機器にご使用の場合は、弊社までお問合せ下さい。

ELV, RoHS適合品

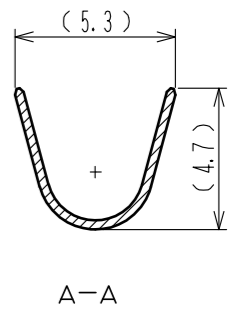
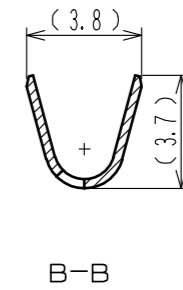
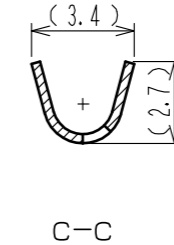
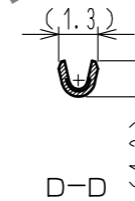
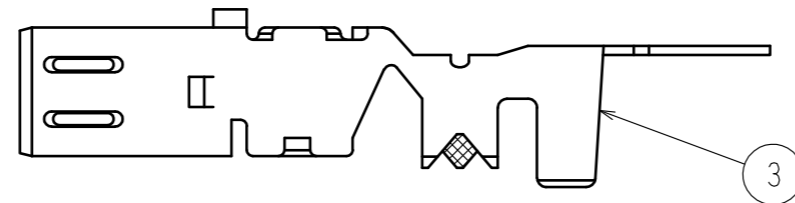
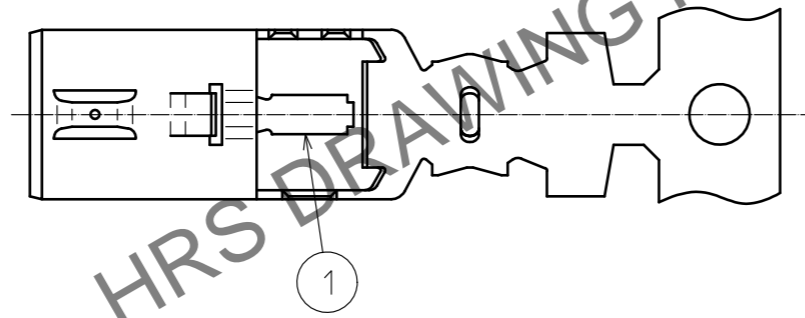
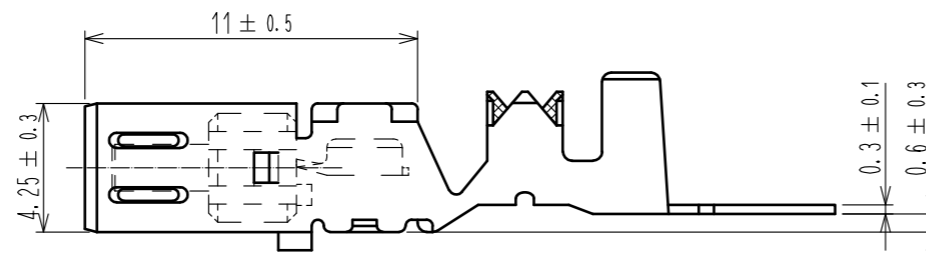
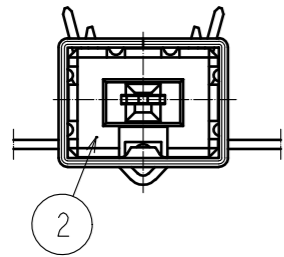
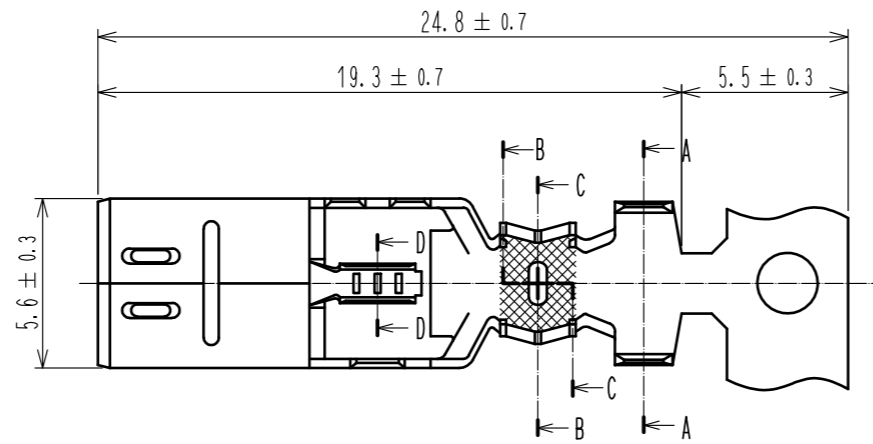

HRS DRAWING FOR REFERENCE

注) 1. 1リール巻き数は、3000本とする。

2	PBT	ダークグレー, UL94HB			
1	銅合金	すずめっき	3	銅合金	すずめっき
NO.	MATERIAL	FINISH, REMARKS	NO.	MATERIAL	FINISH, REMARKS
UNITS mm		SCALE 4 : 1	COUNT 	DESCRIPTION OF REVISIONS	DESIGNED
HIROSE ELECTRIC CO., LTD.		APPROVED : KI. HIROKAWA	20200327	DRAWING NO. ADC-165699-55-00	
		CHECKED : MO. OKADA	20200327	PART NO. GT13-30/1.6-2.9SCF(55)	
		DESIGNED : NK. IKUTA	20200327	CODE NO. CL763-0012-0-55	
		DRAWN : YK. MITSUISHI	20200318	1/1	