

Jun.1.2022 Copyright 2022 HIROSE ELECTRIC CO., LTD. All Rights Reserved.
In case of consideration for using Automotive equipment / device which demand high reliability, kindly contact our sales window correspondents.

ELV, RoHS COMPLIANT

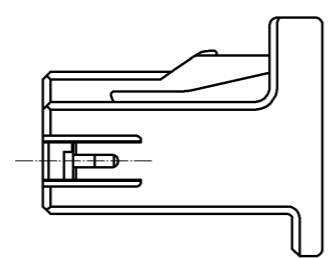

2 RETAINER FIXED

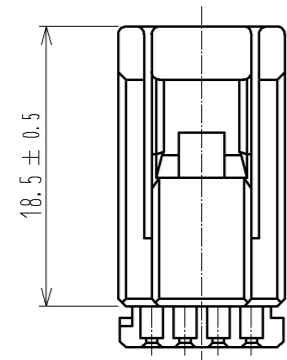
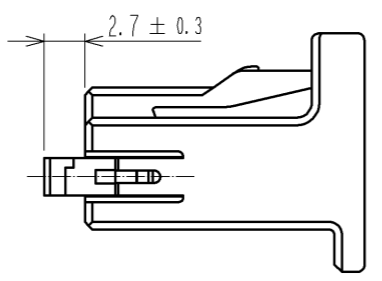
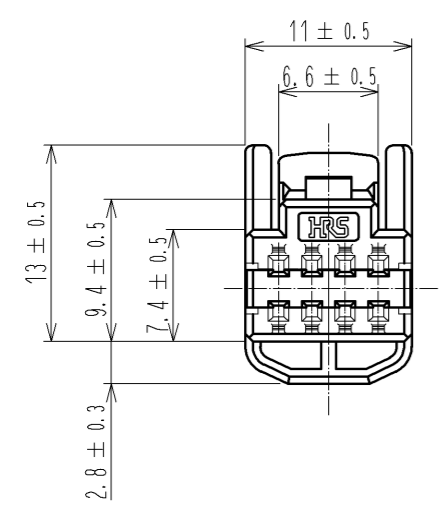

1 RETAINER PRESET

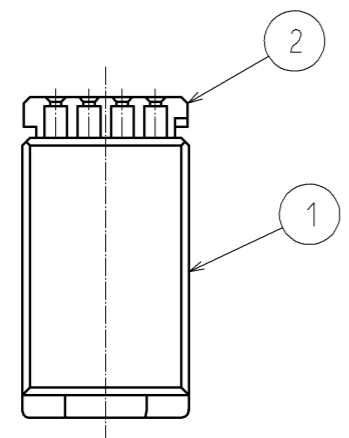

- NOTES
- 1 This product consists of a housing and a preset retainer.
 - 2 Fix the retainer to the prescribed position after inserting all contacts into the housing.
 3. The specification of packing:
 - (1) Products are packed using tray (A) and tray (B) (156pcs/tray).
 - (2) Buffer material (suntec foam sheet) are put into the space between products and trays.
 - (3) Tray (A) and tray (B) are lapped over each other alternately in six layers, and the top tray is an empty tray.
 - (4) A cardboard pad 340-235 are put each under the bottom tray and on the upper tray.

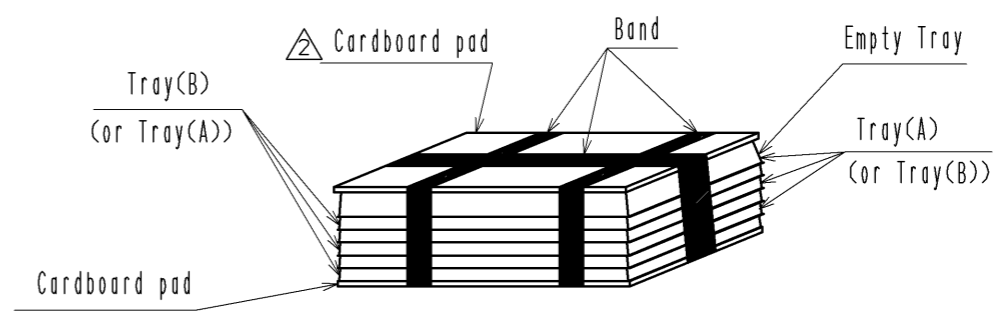
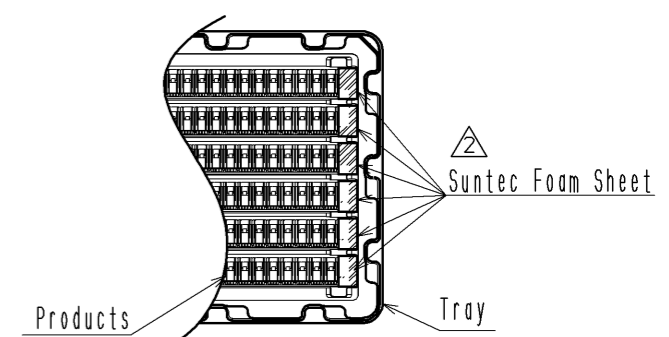

- (5) The stacked trays (6 layers) are fixed with band at 3 places and packed with a carton (156 X 5 = 780pcs/carton).
- (6) Buffer material (suntec foam sheet) are put into the space between trays and carton (3 places).

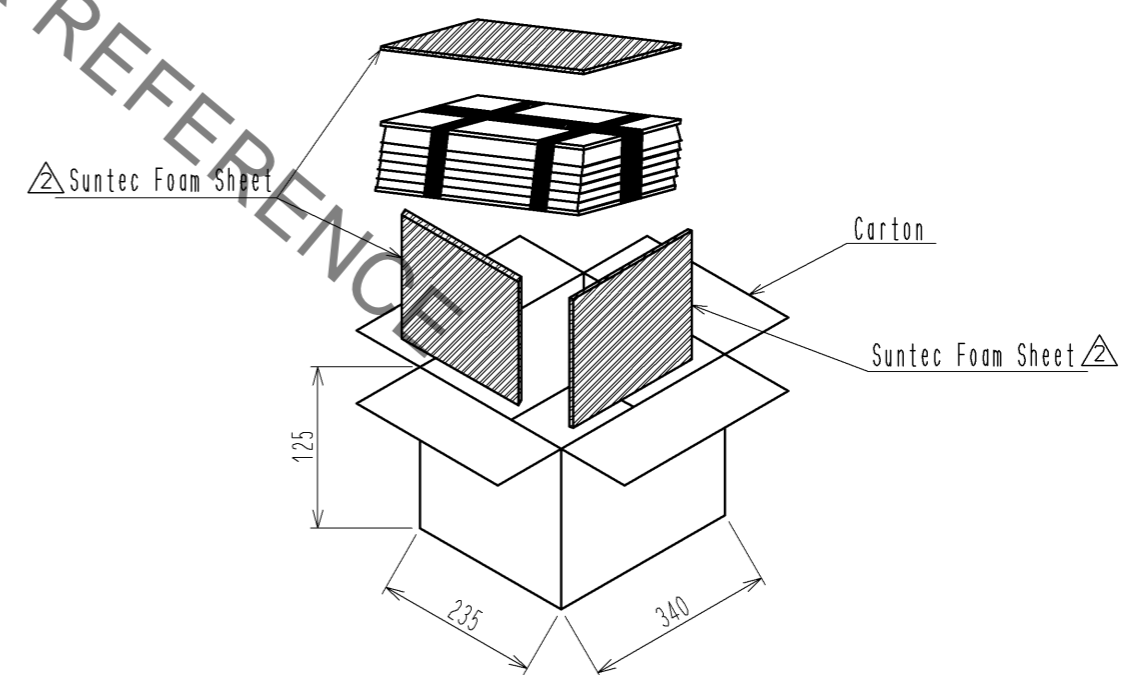

| | | | | | |
|---------------------------|----------|--------------------------|------------|-------------------------------|--------------------------|
| 1 | PPE | BLACK | 2 | PBT | DARK GRAY |
| NO. | MATERIAL | FINISH . REMARKS | NO. | MATERIAL | FINISH . REMARKS |
| UNITS mm | | SCALE 2 : 1 | COUNT 7 | DESCRIPTION OF REVISIONS | |
| | | | | DESIGNED Chinaik.Ng | CHECKED TK.SHISHIKURA |
| | | | | DATE 14.04.25 | |
| | | APPROVED : NH. NAKATA | 13.06.18 | DRAWING NO. EDC3-169396-00 | |
| HIROSE ELECTRIC CO., LTD. | | CHECKED : TK. SHISHIKURA | 13.06.18 | PART NO. GT25-8DS-HU/R | |
| | | DESIGNED : Chinaik.Ng | 13.06.18 | CODE NO. CL775-0059-3-00 | |
| | | DRAWN : Chinaik.Ng | 13.06.18 | | |