

BNC Series

BNC Coaxial Connector

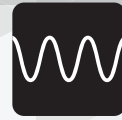

RF



MIL Standard



Wide Variation



Feb. 1. 2025 Copyright 2025 HIROSE ELECTRIC CO., LTD. All Rights Reserved.



Features

1. 50Ω Impedance Matching Type, Coaxial Connector

BNC Series is the most widely used among 50Ω impedance matching coaxial connectors.
(75Ω type is also available. *Series Name: BNC75 Series)

2. Bayonet Lock Type

Features an easy-to-detach design that suits applications requiring high mating durability.

3. Applicable Cable

Compatible with coaxial cables having an outer diameter from $\phi 3$ to $\phi 8$.

4. Applicable Standards

MIL-C-39012
IEC 60169-16
JIS C 5411

Previously registered on the Ministry of Defense specifications document DSP C 6206 (abolished in 2001).

5. RoHS2 Compliant

Product Specifications

Nominal Characteristic Impedance	50 Ω	Operating Temperature	-30 to +60°C
Rated Voltage	500V AC	Operating Relative Humidity	85% Max.
Frequency Range (Note)	0 to 2GHz		

Note: At low frequencies (0 to 200MHz), using a 75 Ω cable (such as 3C-2V) with a 50 Ω system does not impact electrical performance.

Items	Specifications	Conditions
Contact Resistance	3m Ω Max.	100mA DC Max.
Insulation Resistance	1000M Ω Min.	500V DC
Withstanding Voltage	No insulation breakdown	1500V AC for 1min.
V.S.W.R.*	1.2 Max.	0 to 2GHz
Mating Durability	Contact Resistance 10m Ω Max.	1000 cycles
Vibration Resistance	No electrical discontinuity of 1 μ s or more No damage, cracks, or parts dislocation	Frequency 10 to 500Hz, single amplitude of 0.75mm, acceleration of 98m/s ² , 10 cycles in the direction of each of the 3 axis.
Shock Resistance	No electrical discontinuity of 1 μ s or more No damage, cracks, or parts dislocation	Acceleration of 490m/s ² , duration 11ms, sine half-wave waveform, 3 cycles in each of 3 axis
Humidity	Insulation Resistance 100M Ω Min. (in a high humidity environment) Insulation Resistance 1000M Ω Min. (in a dry environment) No damage, cracks, or parts dislocation	Temperature: +25°C to +65°C Humidity: 90 to 96% , 10 cycles (left for 240 hours)
Heat Shock Resistance	No damage, cracks, or parts dislocation	(-55°C : 30min. → +5 to +35°C : Within 5 minutes → +85°C : 30min. → +5 to +35°C Within 5 minutes) 5 cycles
Corrosion Resistance	No corrosion that impairs function.	5% salt water solution, 48 hours

*May differ from the specifications above, depending on products.

*The V.S.W.R. specification values were measured by the measurement system shown below.

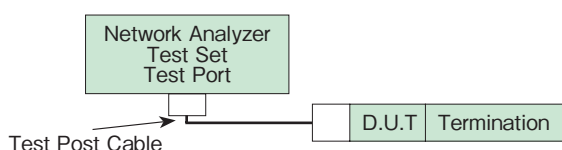

Materials / Finish

Parts	Material	Finish	Remarks
Exterior (Shell)	Brass	Silver Plated Nickel Plated	—
Male Contact	Brass	Silver Plated Gold Plated	—
Female Contact	Beryllium Copper	Silver Plated Gold Plated	—
Insulator	PTFE Resin	—	Noncombustible
Gasket	Silicone Rubber	—	—

Note: Silver plating combines with sulfur in the air to form silver sulfide, which discolors, but does not affect its properties.

About Discoloration of Silver Plating

The discoloration affects only the surface. The contact area is cleaned during connection, ensuring reliable electrical performance.

Product Number Structure

Refer to the chart below when determining the product specifications from the product number.
Please select from the product numbers listed in this catalog when placing orders.

Standard Products

BNC - L R - PC (##)

① ② ③ ④ ⑤

① Series Name	BNC	④ 1) Plug, Jack 2) Receptacle 3) Others	Applicable Cable (Abbreviation) PC : PCB-mounted Identification No.
② Connector Shape	None: Straight L : Right Angle T : T-shape		
③ Connector Type	P : Plug J : Jack PJ : Panel Jack R : Receptacle PR : Plug Receptacle A : Adaptor PA : Panel Adaptor	⑤ Other Specifications	

MIL Standard

UG - 88 D /U

① ② ③ ①

① High Frequency Coaxial Connector	UG	② Identification No.	
		③ Modification	

NTT Specifications

3C V - P 2

① ② ③ ④

① 3C Type (BNC)	3C	③ Connector Type	
② Applicable Cable (Abbreviation)		④ Identification No.	

Functional Diagram

Plug Side

■ Straight Plug
Representative Product : UG-88/U(41)



■ Right Angle Plug
UG-913/U(42)



■ Straight Plug Receptacle
(Mated Portion: Plug)
BNC-BPR-3(40)



■ Various Conversion Adapters (BWA Series)

■ Cap
CW-123A/U(44)



■ Short Plug
JCW-159/U(41)



■ Non-Reflective Terminator
● Mated Portion: Plug
BNC-TMP-*



Jack Side

■ Straight Jack
Representative Product : UG-89/U(41)



■ Panel Jack
Representative Product : BNC-PJ-1.5DV-1(40)



■ Straight Receptacle
● Frange
Representative Product : BNC-R-14(41)
● Nut
Representative Product : UG-625/U(40)
● PCB-Mounted Type
Representative Product : BNC-R-PC(40)



■ Right Angle Receptacle
● Frange
BNC-LR(43)
● PCB-Mounted Type
Representative Product : BNC-LR-PC(41)



■ Various Conversion Adapters (BWA Series)

■ Non-Reflective Terminator
● Mated Portion: Jack
BNC-TMJ-*



Plug-Jack In-Line Adapter

■ Right Angle Adaptor
● Mated Portion:
Jack-Plug
UG-306/U(41)



Plug-Plug In-Line Adapter

■ Straight Adaptor
Mated Portion:
Jack-Jack
Representative Product : BNC-A-JJ(41)



■ Panel Adaptor
● Mated Portion:
Jack-Jack
Representative Product : BNC-PA-JJ(41)



■ T-shape Adaptor
● Mated Portion:
Jack-Jack
-Jack
BNC-TA-JJJ(41)



Plug

● Straight Plug

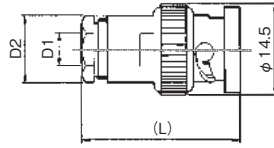

Part No.	HRS No.	Applicable Cable	D1	D2	L	Purchase Unit
UG-88/U(41)	CL0302-0001-0-41	RG-55/U, RG-58/U	φ 5.4	φ 11.1	26.5	20pcs per bag
3CT-P(42)	CL0302-0210-0-42	3C-2T	φ 8	φ 15	29.7	
3CW-P(40)	CL0302-0209-1-40	3C-2W	φ 7.1	φ 15	29.7	
3CV-P2(46)	CL0302-0202-2-46	3C-2V	φ 6.3	φ 13.7	29.5	

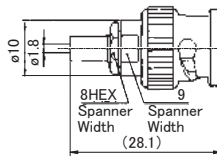

Part No.	HRS No.	Applicable Cable	Purchase Unit
BNC-P-1.5CR(41)	CL0302-0294-0-41	1.5D-2V, 1.5C-2V	20pcs per bag
BNC-P-1.5WCR(41)	CL0302-0295-3-41	1.5D-2W, 1.5C-2W	

● Right Angle Plug

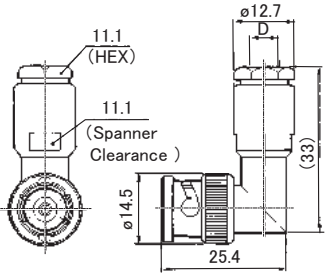

Part No.	HRS No.	Applicable Cable	D	Remarks	Purchase Unit
UG-913/U(42)	CL0302-0043-0-42	RG-55/U, RG-58/U	φ 5.4	Indication: BNC-LP-58U	20pcs per bag

Feb. 1. 2025 Copyright 2025 HIROSE ELECTRIC CO., LTD. All Rights Reserved.

Jack

● Straight Jack

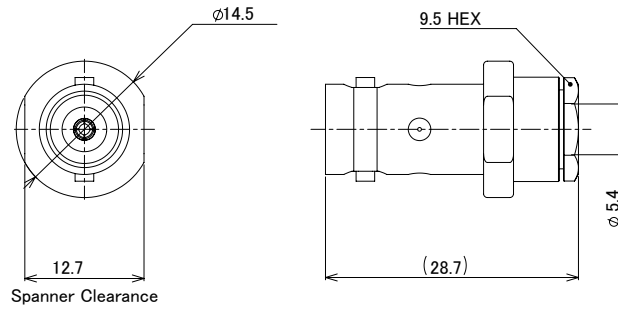

Part No.	HRS No.	Applicable Cable	D	W1	L	Purchase Unit
UG-89/U(41)	CL0302-0034-0-41	RG-55/U, RG-58/U	φ 5.4	12.7	28.7	20pcs per bag

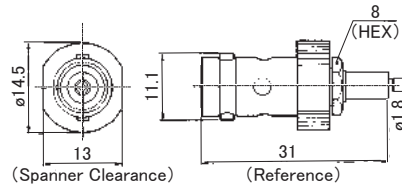

Part No.	HRS No.	Applicable Cable	Purchase Unit
BNC-J-1.5CR(41)	CL0302-0296-6-41	1.5D-2V, 1.5C-2V	20pcs per bag

● Panel Jack (Flange)

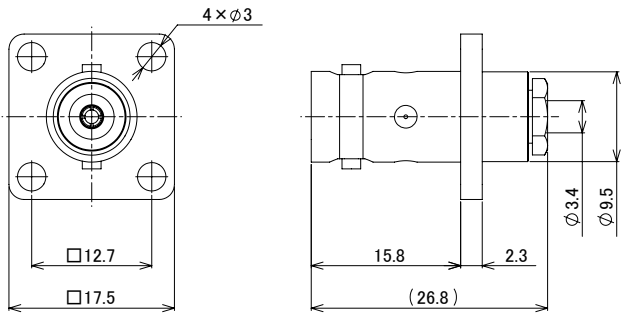

Part No.	HRS No.	Applicable Cable	D1	D2	L1	L2	G	W	Mounting Hole Dimension	Purchase Unit
BNC-PJ-1.5DV-1(40)	CL0302-0285-0-40	1.5D-2V	φ 3.4	φ 9.5	26.8	18.1	φ 3	7	1-2	20pcs per bag

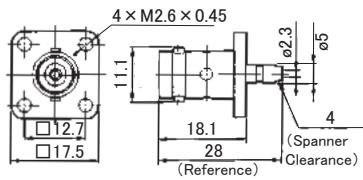

Part No.	HRS No.	Applicable Cable	Mounting Hole Dimension	Purchase Unit
BNC-PJ-196/U(41)	CL0302-0194-6-41	RG-196A/U	1-1	20pcs per bag

Feb. 1. 2025 Copyright 2025 HIROSE ELECTRIC CO., LTD. All Rights Reserved.

● Panel Jack (Nut)

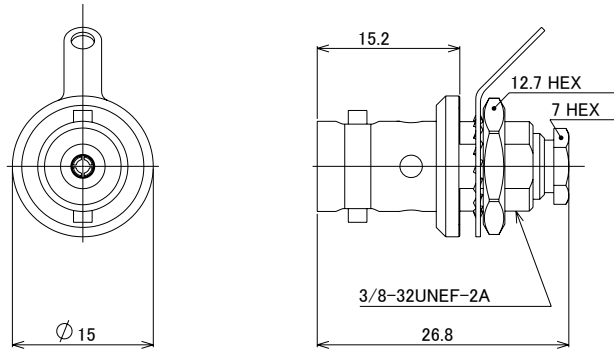

Part No.	HRS No.	Applicable Cable	Mounting Hole Dimension	D	Purchase Unit
BNC-BPJ-1.5-1(40)	CL0302-0252-0-40	1.5D-2V	2-1	φ 3.5	20pcs per bag

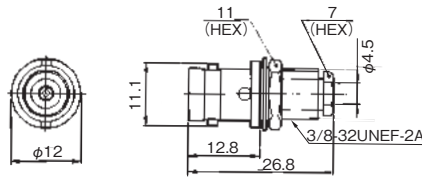

Part No.	HRS No.	Applicable Cable	Mounting Hole Dimension	Purchase Unit
BNC-BPJ-1.5W(40)	CL0302-0284-7-40	1.5D-2W	3-1	20pcs per bag

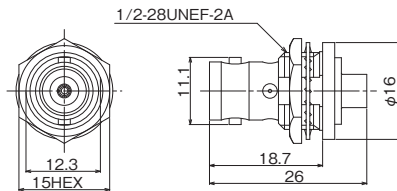

Part No.	HRS No.	Applicable Cable	Mounting Hole Dimension	Purchase Unit
BNC-BPJ-1.5DV(40)	CL0302-0393-2-40	1.5D-2V	2-3	20pcs per bag
BNC-BPJ-1.5DW(40)	CL0302-0400-6-40	1.5D-2W	2-3	

Feb. 1. 2025 Copyright 2025 HIROSE ELECTRIC CO., LTD. All Rights Reserved.

Receptacle

● Straight Receptacle (Flange)

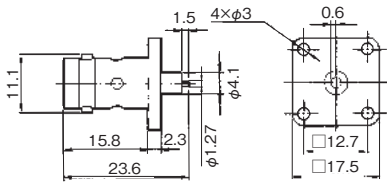

Part No.	HRS No.	Remarks	Mounting Hole Dimension	Purchase Unit
BNC-R-14(41)	CL0302-0245-5-41	Round and Half Cut Terminal	1-4	20pcs per bag

● Straight Receptacle (Nut)

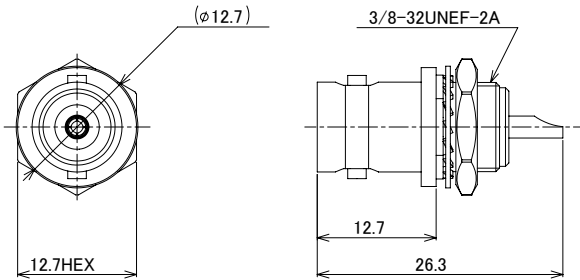

Part No.	HRS No.	D	L1	L2	Panel Thickness	Mounting Hole Dimension	Purchase Unit
UG-625/U(40)	CL0302-0017-0-40	φ 12.7	26.3	12.7	3	2-2	20pcs per bag

Feb. 1. 2025 Copyright 2025 HIROSE ELECTRIC CO., LTD. All Rights Reserved.

● Straight Receptacle (PCB-mounted)

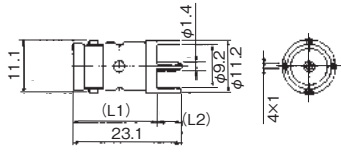

Part No.	HRS No.	L1	L2	Mounting Hole Dimension	Purchase Unit
BNC-R-PC(40)	CL0302-0241-4-40	18.1	5	4-1	20pcs per bag
BNC-R-PC-7(40)	CL0302-0280-6-40	20.64	2.46	4-1	

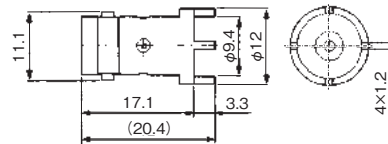

Part No.	HRS No.	Mounting Hole Dimension	Purchase Unit
BNC-R-PC-2(41)	CL0302-0243-0-41	6-1	20pcs per bag

● Right Angle Receptacle (Flange)

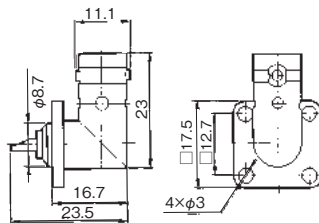

Part No.	HRS No.	Mounting Hole Dimension	Purchase Unit
BNC-LR(43)	CL0302-0020-5-43	1-3	20pcs per bag

Feb. 1. 2025 Copyright 2025 HIROSE ELECTRIC CO., LTD. All Rights Reserved.

● Right Angle Receptacle (PCB-mounted)

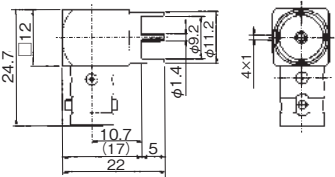
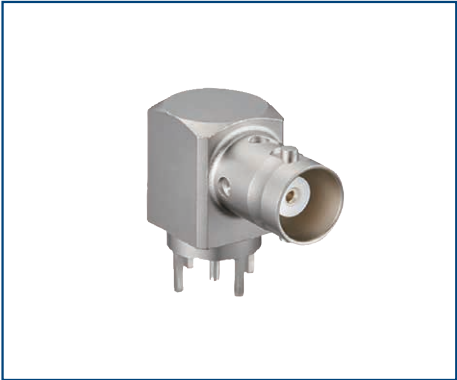

Part No.	HRS No.	Mounting Hole Dimension	Purchase Unit
BNC-LR-PC(41)	CL0302-0242-7-41	4-1	40pcs per tray

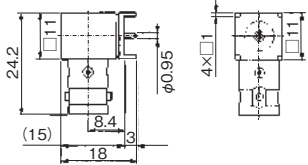
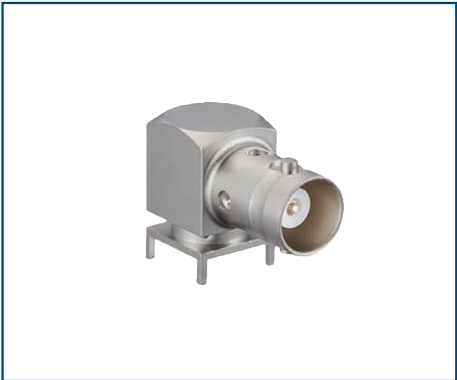

Part No.	HRS No.	Mounting Hole Dimension	Purchase Unit
BNC-LR-PC-1(41)	CL0302-0262-4-41	5-1	50pcs per tray

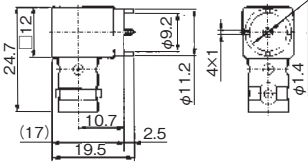

Part No.	HRS No.	Mounting Hole Dimension	Purchase Unit
BNC-LR-PC-3(41)	CL0302-0276-9-41	4-1	40pcs per tray

Feb. 1. 2025 Copyright 2025 HIROSE ELECTRIC CO., LTD. All Rights Reserved.

Plug Receptacle (Nut)

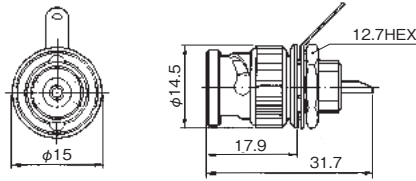

Part No.	HRS No.	Mounting Hole Dimension	Purchase Unit
BNC-BPR-3(40)	CL0302-0249-6-40	2-1	20pcs per bag

Note: Mated portion is plug.

Ground Lug Contact

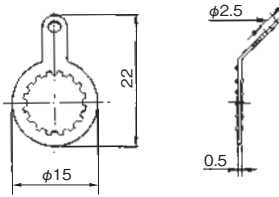

Part No.	HRS No.	Remarks	Purchase Unit
BNC-EL(01)	CL0302-0079-8-01	Ground Lug Contact	300pcs per bag

Adaptor

● Straight Adaptor (Mated Portion: Jack-Jack)

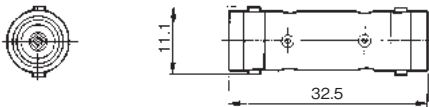

Part No.	HRS No.	Purchase Unit
BNC-A-JJ(41)	CL0302-0039-3-41	20pcs per bag

● Straight Adaptor (Mated Portion: Jack-Jack)

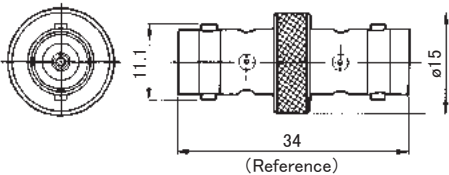

Part No.	HRS No.	Purchase Unit
BNC-A-JJ-1(42)	CL0302-0050-6-42	20pcs per bag

● Straight Adaptor (Panel Adaptor) (Mated Portion: Jack-Jack)

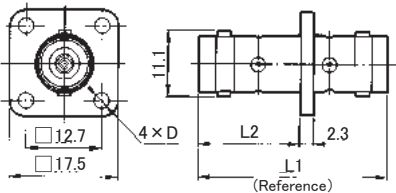
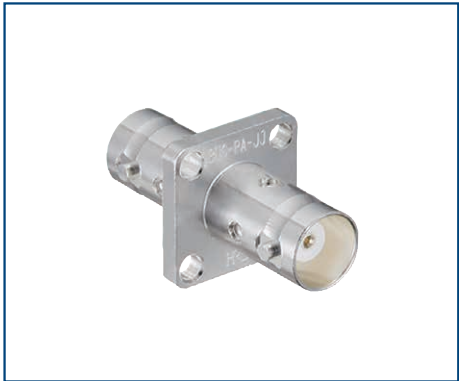

Part No.	HRS No.	L1	L2	D	Mounting Hole Dimension	Purchase Unit
BNC-PA-JJ(41)	CL0302-0052-1-41	34	15.85	φ 3	1-1	20pcs per bag
UG-414/U(41)	CL0302-0040-2-41	32.5	17.6	M2.6 × 0.45		

Feb. 1. 2025 Copyright 2025 HIROSE ELECTRIC CO., LTD. All Rights Reserved.

● Straight Adaptor (Mated Portion: Plug-Plug)

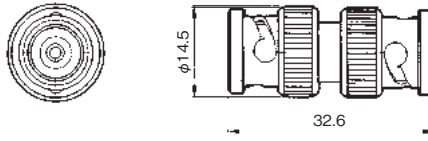

Part No.	HRS No.	Purchase Unit
UG-491/U(41)	CL0302-0022-0-41	20pcs per bag

● Right Angle Adaptor (Mated Portion: Plug-Jack)

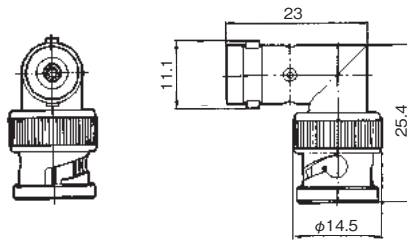

Part No.	HRS No.	Purchase Unit
UG-306/U(41)	CL0302-0023-3-41	20pcs per bag

● T-shape Adaptor (Mated Portion: Jack-Jack-Jack)

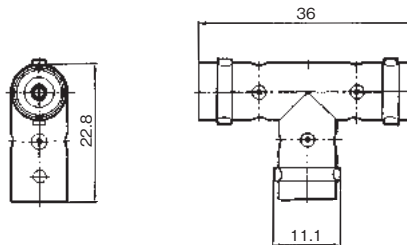

Part No.	HRS No.	Purchase Unit
BNC-TA-JJJ(41)	CL0302-0024-6-41	20pcs per bag

Cap

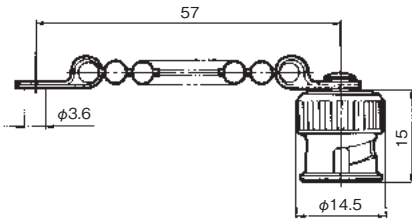

Part No.	HRS No.	Purchase Unit
CW-123A/U(44)	CL0302-0041-5-44	20pcs per bag

Short Plug

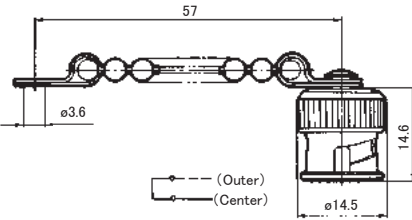

Part No.	HRS No.	Purchase Unit
JCW-159/U(41)	CL0302-0026-1-41	20pcs per bag

Mounting Hole Dimension

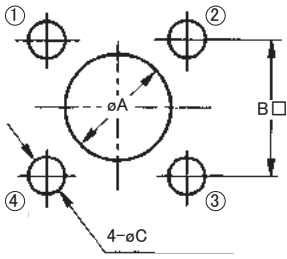

Diagram 1

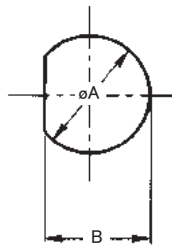

Diagram 2

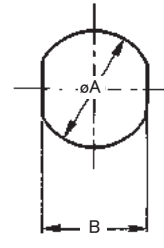

Diagram 3

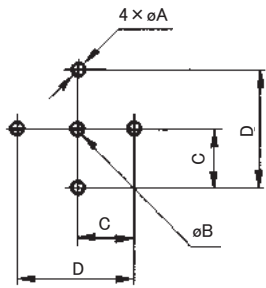

Diagram 4

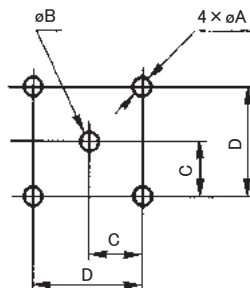

Diagram 5

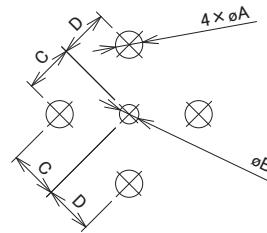
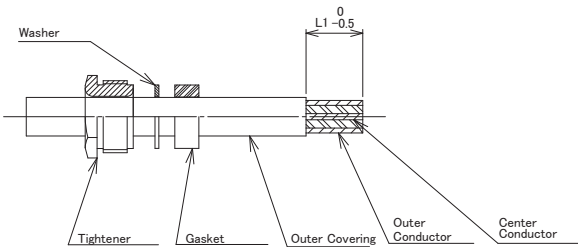

Diagram 6

Diagram No.	No.	A	B	C	D
1	1-1	11.4	12.7	3	—
	1-2	9.8		3.2	—
	1-3	9		3.2	—
	1-4	4.3			—
2	2-1	$9.6^{+0.1}_0$	$9^{+0.1}_0$	—	—
	2-2	$11.3^{+0.1}_0$	$10.3^{+0.1}_0$	—	—
	2-3	$13.2^{+0.1}_0$	$12.4^{+0.1}_0$	—	—
3	3-1	$9.6^{+0.1}_0$	$8.5^{+0.1}_0$	—	—
4	4-1	$1.6^{+0.1}_0$	$1.6^{+0.1}_0$	5.08 ± 0.05	10.16 ± 0.05
5	5-1	$1.8^{+0.1}_0$	$1.8^{+0.1}_0$		
6	6-1	$2.1^{+0.15}_{-0.05}$	1.5 ± 0.1	$3.8^{0}_{-0.1}$	$3.8^{0}_{-0.1}$

Cable Assembly Procedure

- The ends are processed as show in the drawing below. (Refer to chart 1)
End Processing: Refer to the drawing and Chart 1 for end processing dimensions L1 specific to each part number.



- Insert the clamp at the cable tip, fold back the outer conductor onto the clamp, and trim any excess with a knife.
- Cut the center conductor to length L2 from the insulation surface (Surface A). See Table 1 for dimensions L2 and L3 (L3 is for reference).

Note: Avoid damaging the center conductor during cutting.

- Solder contact and center conductor. Soldering the contact preliminarily in advance is recommended.

Note: Ensure no gaps exist between the cable end and the insulation.

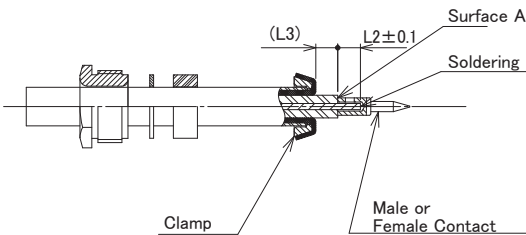

- Insert the cable and assembled parts into the connector shell. Securely tighten the nut to 2-3 N·m to ensure a firm assembly.

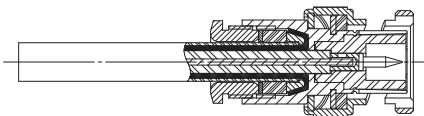

Chart 1: End Processing Dimensions by Part Number.

Part No.	HRS No.	L1	L2	L3
UG-88/U(41)	CL0302-0001-0-41 (Note)	7.5	3	2.9
UG-89/U(41)	CL0302-0034-0-41	7.5		2.9
UG-913/U(42)	CL0302-0043-0-42 (Note)	7.4		2.4
3CV-P2(46)	CL0302-0202-2-46 (Note)	9.6		5
3CT-P(42)	CL0302-0210-0-42 (Note)	10.9		5

Unit : mm

Note: Standard Product

Feb. 1. 2025 Copyright 2025 HIROSE ELECTRIC CO., LTD. All Rights Reserved.

Conversion Adapter List (BWA Series)

Please refer "conversion adapter " for outer diameter dimensions

Mated Portion 1		Mated Portion 2		Part No.	HRS No.
Series Name	Mated Portion	Series Name	Mated Portion		
BNC	Plug	MSS	Jack	BNCP-MSSJ(40)	CL0311-0082-3-40
		SMA (HRM)	Plug	HRM-519(40)	CL0311-0101-6-40
			Jack	HRM-518(40)	CL0311-0100-3-40
	Jack	N	Plug	JUG-201A/U(40)	CL0311-0007-8-40
		UM	Jack	BNCJ-UMJ-PA(44)	CL0311-0103-1-44
		MSS	Plug	BNCJ-MSSP(40)	CL0311-0081-0-40
		SMA (HRM)	Plug	HRM-517(40)	CL0311-0099-6-40
			Jack	HRM-516(40)	CL0311-0102-9-40

Feb. 1. 2025 Copyright 2025 HIROSE ELECTRIC CO., LTD. All Rights Reserved.

While Taking into Consideration

Specifications mentioned in this catalog are reference values.

When considering to order or use this product, please review the Drawing and Product Specifications sheets.

Use an appropriate cable when using the connector in combination with cables.

If considering usage of a non-specified cable, please contact your sales representative.

If assembly process is done by jigs & tools which are not identified by Hirose, the warranty of the product may be affected.

If considering usage for below mentioned applications, please contact your sales representative.

In cases where the application will demand a high level of reliability, such as automotive, medical instruments, public infrastructure, aerospace/defense etc. Hirose must review before assurance of reliability can be given.

BNC-TM Series

BNC Coaxial Connector / Non-Reflective Terminator



RF



MIL Standard

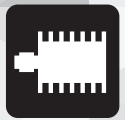

Terminator



Product Number Structure

BNC - TM P - 05 (##)

① ② ③ ④ ⑤

① Connector Name	BNC Series	④ Power	Ex : 05 : 0.5W 1 : 1W
② TM	Non-Reflective Terminator		
③ Connector Type	P : Plug Type J : Jack Type	⑤ Specifications	40-49 and 50-59 satisfy RoHS compliant.

Non-Reflective Terminator

● Connector Type Plug

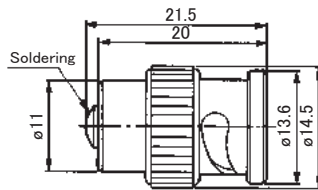

Part No.	HRS No.	Frequency (GHz)	V.S.W.R. (Max)	Power (W)	Characteristic Impedance (Ω)	DC Resistance (Ω)	Purchase Unit
BNC-TMP-05(50)	CL0353-0094-4-50	0-1	1.10	0.5	50	50 ± 2	20pcs per bag
		1-3	1.20				

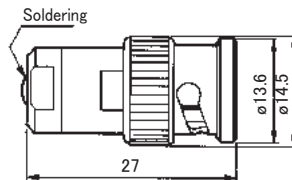

Part No.	HRS No.	Frequency (GHz)	V.S.W.R. (Max)	Power (W)	Characteristic Impedance (Ω)	DC Resistance (Ω)	Purchase Unit
BNC-TMP-1(50)	CL0353-0019-9-50	0-1	1.15	1	50	50 ± 2	20pcs per bag
		1-2	1.20				
		2-4	1.25				

● Connector Type Jack

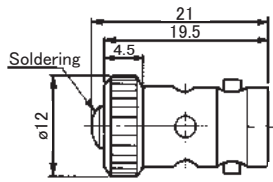

Part No.	HRS No.	Frequency (GHz)	V.S.W.R. (Max)	Power (W)	Characteristic Impedance (Ω)	DC Resistance (Ω)	Purchase Unit
BNC-TMJ-05(52)	CL0353-0095-7-52	0-1	1.10	0.5	50	50 ± 0.5	20pcs per bag
		1-3	1.20				

While Taking into Consideration

Specifications mentioned in this catalog are reference values.

When considering to order or use this product, please review the Drawing and Product Specifications sheets.

Use an appropriate cable when using the connector in combination with cables.

If considering usage of a non-specified cable, please contact your sales representative.

If assembly process is done by jigs & tools which are not identified by Hirose, the warranty of the product may be affected.

If considering usage for below mentioned applications, please contact your sales representative.

In cases where the application will demand a high level of reliability, such as automotive, medical instruments, public infrastructure, aerospace/defense etc. Hirose must review before assurance of reliability can be given.

HIROSE

HRS

HIROSE ELECTRIC CO.,LTD.

2-6-3 Nakagawa Chuoh, Tsuzuki-Ku, Yokohama-Shi 224-8540, JAPAN
<https://www.hirose.com>