

LF Series

Shielded Small Waterproof Connector



Bayonet



Waterproof



CAT6A



Mar. 1. 2026 Copyright 2026 HIROSE ELECTRIC CO., LTD. All Rights Reserved.



Features

1. Small, Robust Design

Small, robust design with metal shell

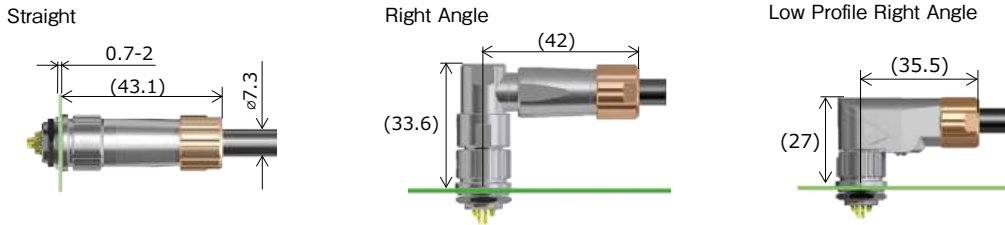

* Illustrations are different from actual sizes.
* The dimensions are different when it is mated with the rear mount type.

Dimensions Example
(LF10 Plug Mated with Front Mount Receptacle)

2. Bayonet Lock

User-friendly lock with superior vibration resistance.

Mating: Insert the plug, and then turn the locking collar clockwise, as indicated by the coupling direction marking.

Un-mating: Turn the locking collar counter-clockwise then pull off the plug.

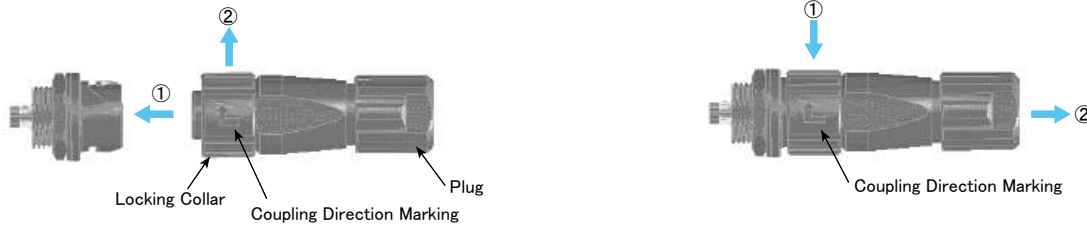

Lock Design

3. Waterproof: IPX7/IPX8* Compliant

IPX7/IPX8 waterproof performance when mated.

*IPX7: Left at a water depth of 1 meters for 30 minutes in mated condition.
*IPX8: Left at a water depth of 2 meters for 14 days in mated condition.

4. Easy Shielding Termination

The cable shield is easily connected to the connector shell by attaching the metal clamp to the cable sheath.

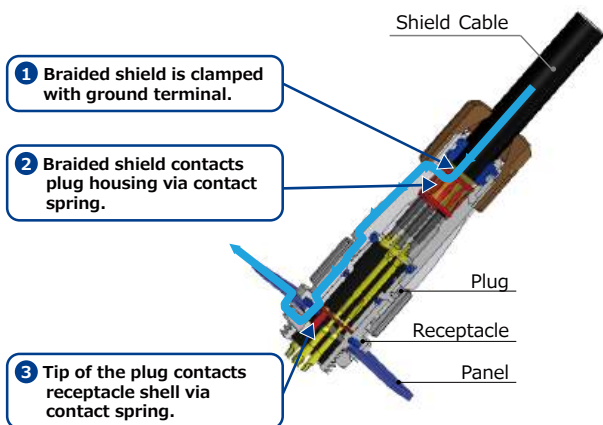

Shield Connection Phase Diagram

5. Easy Assembly

Assembly using four included components easily completes the waterproof and shield design. The plug design reduces component and assembly costs.

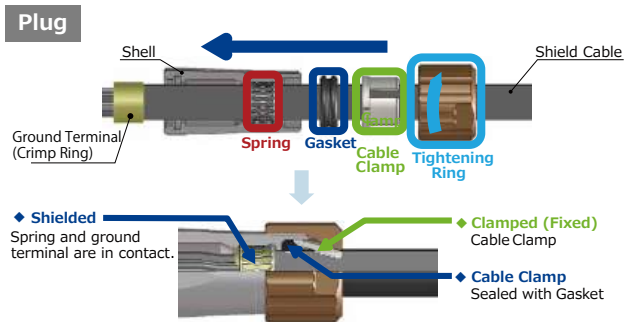

6. Wide Variety of Configurations

- 2 types of cable assembly: solder and crimp
- Hybrid type with power and signal contacts in a single shell for space-saving
- Plug with easy to grip sleeve that prevents slipping for enhanced operability
- 2 receptacle mounting options: front mount and rear mount
- Cat.6A compliant

7. High Speed Transmission

Supports Cat.5e(1Gbps) and Cat.6A(10Gbps) high speed Ethernet

Cat.5e(1Gbps)

*Based on EtoE Standard Class D 3-Conn E3

*Characteristics depend on pin assignment, cable specifications and cable assembly conditions. Please check prior to use.

*Please contact a Hirose representative for questions on the recommended pin assignment.

Cat.6A(10Gbps)

*Based on TIA 568.2-D Patch cord Cat.6A 1.0m

8. Suited for Long-Term Outdoor Use

Sunshine weather meter test performed for 2,000 hours.

9. Safety Standard Certified

The 4 position variation meets TÜV safety standards at a current of 10A.

The 3 position and 4 position variations also meet UL safety standards.

10. RoHS2 Compliant

Product Specifications

Rated Current	3pos.: 5A 4pos.: 10A 6, 12, 20pos.: 2A Hybrid 6pos.: Power 2pos. 4A, Signal 4pos. 1A Hybrid 11pos.: Power 4pos. 10A, Signal 7pos. 2A 8pos. (Cat.6A): 2A	Operating Temperature (Note 1)	-25 to +85°C
Rated Voltage	3pos.: 125V AC / 175V DC 4pos.: 125V AC/DC 6, 12, 20pos.: 30V AC / 42V DC Hybrid 6pos.: Power 2pos. 60V AC/DC, Signal 4pos. 60V AC/DC Hybrid 11pos.: Power 4pos. 125V AC/DC, Signal 7pos. 30V AC / 42V DC 8pos. (Cat.6A): 50V AC / 60V DC	Storage Temperature Range	-10 to +60°C

Items	Specifications	Conditions
Contact Resistance	3, 6, 12, 20, Hybrid 6pos.: 15m Ω Max. 4pos.: 5m Ω Max. Hybrid 11pos.: Power 4pos. 5m Ω Max., Signal 7pos. 15m Ω Max. 8pos. (Cat.6A): Signal 30m Ω Max., Shield 100m Ω Max.	Measured at 1A DC
Insulation Resistance	1,000M Ω Min. 100M Ω Min. (8pos.)	3, 4pos.: Measured at 500V DC 3, 6, 12, 20, Hybrid 6pos.: Measured at 100V DC Hybrid 11pos.: Power 4pos.: Measured at 500V DC, Signal 7pos.: Measured at 100V DC 8pos. (Cat.6A): Measured at 100V DC
Withstand Voltage	No flashover and insulation breakdown	3, 4pos.: 1,250V AC for 1 min. 3, 6, 12, 20, Hybrid 6pos.: 300V AC for 1 min. Hybrid 11pos.: Power 4pos. 1,250V AC, Signal 7pos.: 300V AC for 1 min. 8pos. (Cat.6A): 1,000V AC for 1 min.
Mating Durability	3, 6, 12, 20, Hybrid 6pos.: 30m Ω Max. 4pos.: 10m Ω Max. Hybrid 11pos.: Power 4pos. 10m Ω Max., Signal 7pos. 30m Ω Max.	1,000 times
Vibration Resistance	No electrical interruption of 10 μs or more. No damage, cracks or parts dislocation.	Frequency: 10 to 55 to 10Hz/cycle Half amplitude 0.75mm, 5 minutes/cycle 10 cycles each in 3 axis directions
Shock Resistance	No electrical interruption of 10 μs or more. No damage, cracks or parts dislocation.	Acceleration: 490m/s ² , duration: 11ms, 3 times each in 3 axis directions
Humidity Resistance (Normal Condition)	Insulation resistance: 10M Ω Min. (at high humidity condition) 100M Ω Min. (at dry condition)	Temperature: 40°C , relative humidity: 90 to 95%, left for 96 hours
Temperature Cycle	Insulation resistance: 100M Ω Min. No damage, cracks or parts dislocation.	-55°C for 30 minutes → Room temperature for 2 to 3 minutes → +85°C for 30 minutes → Room temperature for 2 to 3 minutes, Repeated for 5 cycles.
Water Resistance	No water intrusion inside connector	At a water depth of 1.8 meters for 48 hours in mated condition.

Note 1: Includes temperature rise caused by current flow.

Note 2: Depending on the cable construction and specifications, the cable clamp force, rotational force, waterproof performance, etc. may differ. Please use after confirming in advance.

Materials / Finish

Component	Material	Finish / Remarks	UL
Outer Shell	Zinc Alloy	Nickel Plating	-
	PPS Resin	Brown	UL94V-0
Insulator	PPS Resin	Black	UL94V-0
Contact	Copper Alloy	Partial Gold Plating Over Nickel Underplating	-
Gasket, O-ring	Chloroprene Rubber	Black	-
	Silicone (8pos. (Cat.6A))	Red	-

Product Number Structure

Refer to the chart below when determining the product specifications from the product number. Please select from the product numbers listed in this catalog when placing orders.

● Connector

LF 07 W B P# - 6 S# - A (##)

① ② ③ ④ ⑤ ⑥ ⑦ ⑧ ⑨

① Series Name	LF	⑥ No. of Pos.	
② Shell Size	07, 10, 13	⑦ Contact Gender	P: Male Contact S: Female Contact (Changed specifications for products of the same category.)
③ Specialty	W: Waterproof Type	⑧ Difference in Contact Arrangement	Added when contact arrangement differs from the standard type. A: Contact Arrangement Difference
④ Lock Mechanism	B: Bayonet Lock	⑨ Other Specifications	① to ⑧ # two-digit character is added to indicate other specifications as needed.
⑤ Shell Type	P: Plug LP: Right Angle Plug R: Receptacle J: Jack PH: Plug (Cat.6A) RH: Receptacle (Cat.6A) JH: Jack (Cat.6A) (Changed specifications for products of the same category.)		

● Crimp Contact

HR10 - P C - 1 1 1

① ② ③ ④ ⑤ ⑥

HR12 - S C - 1 1 1

① ② ③ ④ ⑤ ⑥

① Series Name	HR10 HR12 HR30 (Cat.6A)	④ Contact Shape	1: Loose Piece Contact 2: Reel Contact
② Contact Gender	P: Male Contact S: Female Contact	⑤ Design	1: If the design of contacts of the same size differs, 1, 2, 3 etc. are added to distinguish them
③ Contact Assembly	C: Crimp	⑥ Contact Area Plating	1: Gold Plated

Note: The LF Series uses the contacts from the existing HR10/HR12/HR30 Series.

Straight Plug

Solder Type

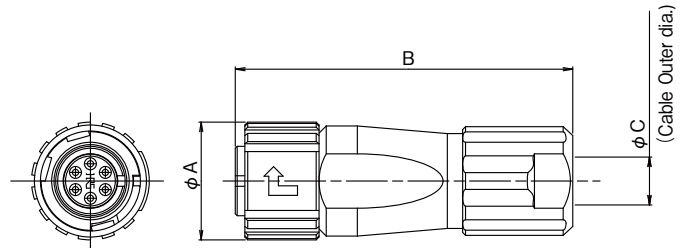

(Example of product appearance.)

Unit : mm

Part No.	HRS No.	Shell Size	No. of Pos.	ϕA	B	ϕC	Weight	Purchase Unit
LF07WBP-3S(31)	CL0136-0003-7-31	LF07	3	12.3	35.8	5.0	11g	50pcs per tray
LF07WBP-3P(31)	CL0136-0004-0-31							
LF07WBP-6S(31)	CL0136-0001-1-31		6					
LF07WBP-6P(31)	CL0136-0002-4-31							
LF07WBP-6S-A(31)	CL0136-0029-0-31	LF07-A	Hybrid 6pos. (Note 1)	12.3	35.8	5.0	11g	
LF07WBP-6P-A(31)	CL0136-0016-0-31							
LF10WBP-4S(31)	CL0136-0005-2-31	LF10	4	14.8	41.8	7.3	17g	
LF10WBP-4P(31)	CL0136-0006-5-31							
LF10WBP-12S(31)	CL0136-0007-8-31		12				16g	
LF10WBP-12P(31)	CL0136-0008-0-31							
LF13WBP-11S	CL0136-0011-5-00	LF13	Hybrid 11pos. (Note 2)	17.9	51.9	8.7	29g	
LF13WBP-11P	CL0136-0012-8-00							
LF13WBP-20S	CL0136-0009-3-00		20					
LF13WBP-20P	CL0136-0010-2-00							

Note 1: Power 2pos.+ Signal 4pos.

Note 2: Power 4pos.+ Signal 7pos.

Easy Lock Solder Type

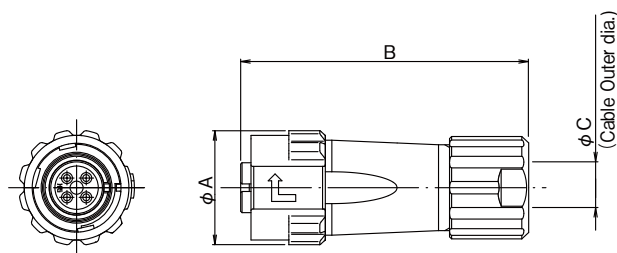

(Example of product appearance.)

Unit : mm

Part No.	HRS No.	Shell Size	No. of Pos.	φ A	B	φ C	Weight	Purchase Unit
LF07WBPD-6S(31)	CL0136-0020-6-31	LF07	6	14.3	35.8	5.0	12g	50pcs per tray
LF10WBPD-4S(31)	CL0136-0014-3-31	LF10	4	16.8	41.8	7.3	19g	
LF10WBPD-4P(31)	CL0136-0017-1-31							
LF10WBPD-12S(31)	CL0136-0015-6-31							
LF10WBPD-12P(31)	CL0136-0018-4-31							

Crimp Type

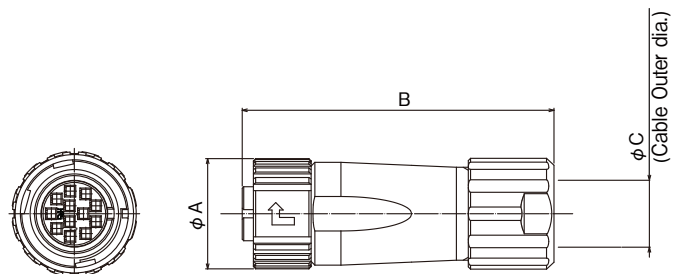

(Example of product appearance.)

Unit : mm

Part No.	HRS No.	Shell Size	No. of Pos.	φ A	B	φ C	Weight	Purchase Unit
LF10WBP-12SC	CL0136-0041-0-00	LF10	12	14.8	41.8	7.3	17g	50pcs per tray
LF13WBP-20PC	CL0136-0040-0-00	LF13	20	17.9	51.9	8.7	27g	
LF13WBP-20SC	CL0136-0044-0-00							

Crimp Type (Cat.6A)

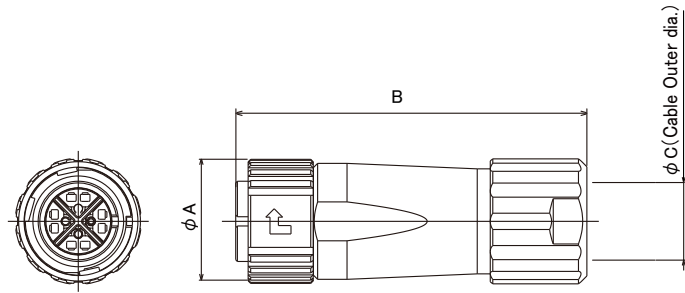

(Example of product appearance.)

Unit : mm

Part No.	HRS No.	Shell Size	No. of Pos.	ϕA	B	ϕC	Weight	Purchase Unit
LF10WBPHA-8PC(40)	CL0136-0065-0-40	LF10	8	14.8	41.8	6.9	18g	50pcs per tray
LF10WBPHB-8PC(40)	CL0136-0072-0-40					6.5		

Right Angle Plug

Solder Type

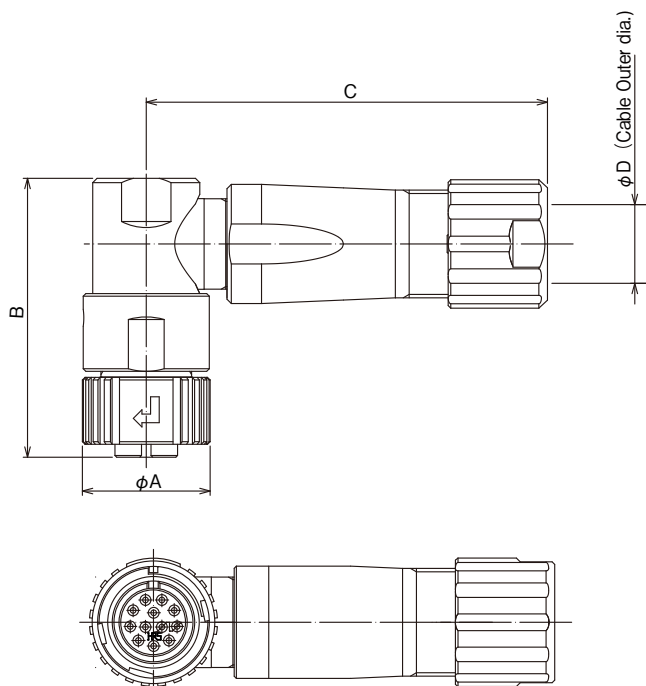

(Example of product appearance.)

Unit : mm

Part No.	HRS No.	Shell Size	No. of Pos.	ϕA	B	C	ϕD	Weight	Purchase Unit
LF07WBLP-6PA(31)	CL0136-0022-1-31	LF07	6	12.3	28.2	34.5	5.0	20g	20pcs per bag
LF10WBLP-12SA(31)	CL0136-0013-0-31	LF10	12	14.8	32.3	42.0	7.3	31g	
LF10WBLP-12PA(31)	CL0136-0025-0-31								
LF13WBLP-11PA	CL0136-0023-4-00	LF13	Hybrid 11pos. (Note)	17.9	33.6	53.4	8.7	49g	1pc per bag
LF13WBLP-20PA	CL0136-0031-0-00		20					50g	10psc per bag

Note: Power 4pos. + Signal 7pos.

Low Profile Solder Type

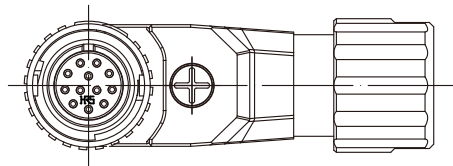
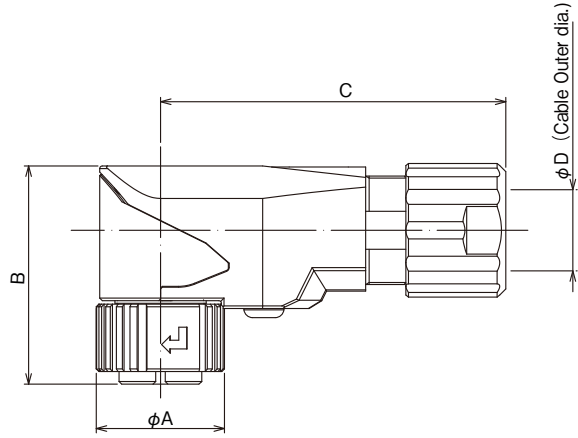

(Example of product appearance.)

Unit : mm

Part No.	HRS No.	Shell Size	No. of Pos.	φ A	B	C	φ D	Weight	Purchase Unit
LF10WBLPA-12P	CL0136-0039-0-00	LF10	12	14.8	25.1	35.5	7.3	34g	50pcs per tray

Receptacle (Front Mount)

Solder Type

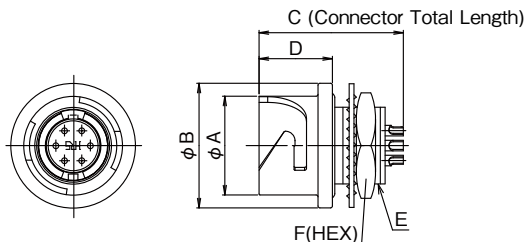

(Example of product appearance.)

Unit : mm

Part No.	HRS No.	Shell Size	No. of Pos.	ϕA	ϕB	C	D	E	F	Weight	Purchase Unit
LF07WBR-3P	CL0136-1003-2-00	LF07	3	10.3	13.0	16.55	7.65	M9 × 0.75	11.0	4g	60pcs per tray
LF07WBR-3S	CL0136-1004-5-00					15.05					
LF07WBR-6P	CL0136-1001-7-00		6			15.25					
LF07WBR-6S	CL0136-1002-0-00										
LF10WBR-4P	CL0136-1005-8-00	LF10	4	12.8	15.3	19.05	7.75	M11 × 0.75	13.0	6g	
LF10WBR-4S	CL0136-1006-0-00					17.25				5g	
LF10WBR-12P	CL0136-1007-3-00		12			17.25				6g	
LF10WBR-12S	CL0136-1008-6-00										
LF13WBR-11P	CL0136-1011-0-00	LF13	Hybrid 11pos. (Note)	15.9	18.3	19.05	7.75	M14 × 0.75	17.0	9g	50pcs per tray
LF13WBR-11S	CL0136-1012-3-00					17.25				10g	
LF13WBR-20P	CL0136-1009-9-00		20			9g					
LF13WBR-20S	CL0136-1010-8-00					10g					

Note: Power 4pos. + Signal 7pos.

Through Hole Type

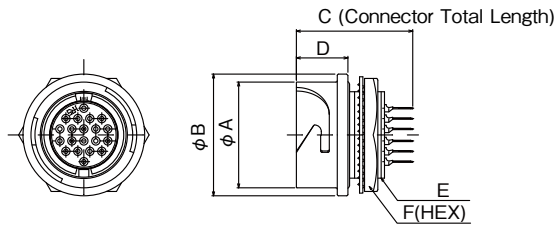

(Example of product appearance.)

Unit : mm

Part No.	HRS No.	Shell Size	No. of Pos.	ϕA	ϕB	C	D	E	F	Weight	Purchase Unit
LF13WBR-20SD	CL0136-1017-7-00	LF13	20	15.9	18.3	17.5	7.75	M14 × 0.75	17.0	9g	50pcs per tray

Crimp Type

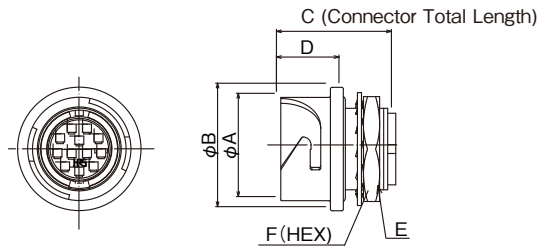

(Example of product appearance.)

Unit : mm

Part No.	HRS No.	Shell Size	No. of Pos.	ϕA	ϕB	C	D	E	F	Weight	Purchase Unit
LF10WBR-12PC	CL0136-0042-0-00	LF10	12	12.8	15.3	14.25	7.75	M11 × 0.75	13.0	6g	50pcs per tray

Receptacle (Rear Mount)

Solder Type

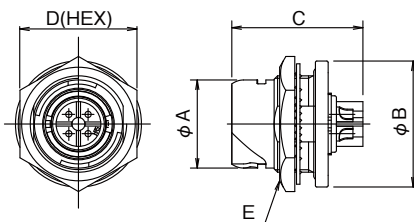

(Example of product appearance.)

Unit : mm

Part No.	HRS No.	Shell Size	No. of Pos.	φ A	φ B	C	D	E	Weight	Purchase Unit
LF07WBRB-6S	CL0136-0054-0-00	LF07	6	10.3	15	17.25	13	M11×0.75	8g	50pcs per tray
LF10WBRB-4P	CL0136-1118-4-00	LF10	4	12.8	18.3	19.05	17	M14×0.75	10g	
LF10WBRB-4S	CL0136-1123-0-00					17.25			11g	
LF10WBRB-12P	CL0136-1013-6-00		12			10g				
LF10WBRB-12S	CL0136-1014-9-00					10g				
LF13WBRB-11P	CL0136-1024-0-00	LF13	Hybrid 11pos. (Note)	15.9	21.5	19.25	20	M17×0.75	15g	10pcs per bag
LF13WBRB-11S	CL0136-1019-2-00								16g	
LF13WBRB-20P	CL0136-1023-0-00		20						16g	20pcs per tray
LF13WBRB-20S	CL0136-1018-0-00									

Note: Power 4pos. + Signal 7pos.

Through Hole Type

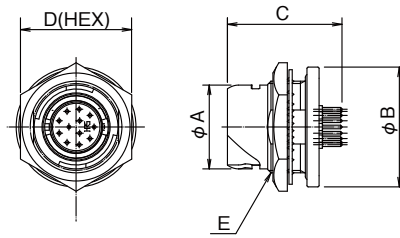

(Example of product appearance.)

Unit : mm

Part No.	HRS No.	Shell Size	No. of Pos.	φ A	φ B	C	D	E	Weight	Purchase Unit
LF07WBRB-3SD(31)	CL0136-1025-0-31	LF07	3	10.3	15.0	20.0	13.0	M11 × 0.5	8g	50pcs per tray
LF07WBRB-6SD(31)	CL0136-1026-0-31		6							
LF07WBRB-6PD-A(31)	CL0136-1021-0-31	LF07-A	Hybrid 6pos. (Note)							
LF07WBRB-6SD-A(31)	CL0136-1022-0-31									
LF10WBRB-12PD	CL0136-1015-1-00	LF10	12	12.8	18.3	17.5	17.0	M14 × 0.75	10g	
LF10WBRB-12SD	CL0136-1016-4-00									
LF13WBRB-20SD	CL0136-1027-0-00	LF13	20	15.9	21.5	20.0	20.0	M17 × 0.75	16g	

Note: Power 2pos. + Signal 4pos.

Through Hole Type (Cat.6A)

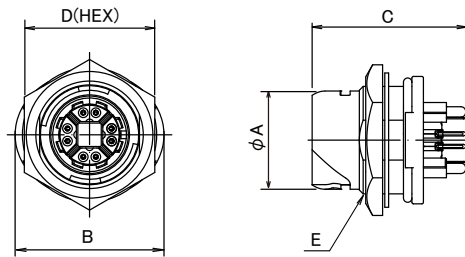

(Example of product appearance.)

Unit : mm

Part No.	HRS No.	Shell Size	No. of Pos.	φ A	B	C	D	E	Weight	Purchase Unit
LF10WBRBH-8SD(40)	CL0136-0058-0-40	LF10	8	12.8	19.4	20.5	17	M14 × 0.75	12g	50pcs per tray

Crimp Type

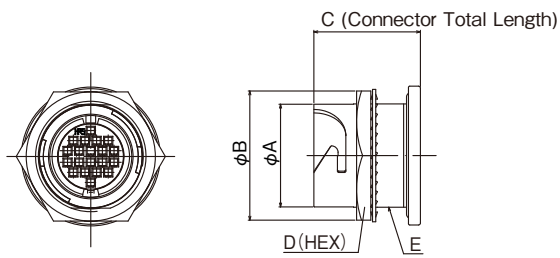

(Example of product appearance.)

Unit : mm

Part No.	HRS No.	Shell Size	No. of Pos.	ϕA	ϕB	C	D	E	Weight	Purchase Unit
LF13WBRB-20SC	CL0136-1033-0-00	LF13	20	15.9	21.5	16.5	20.0	M17 × 0.75	15g	20pcs per bag
LF13WBRB-20PC	CL0136-1124-0-00								14g	

Jack

Solder Type

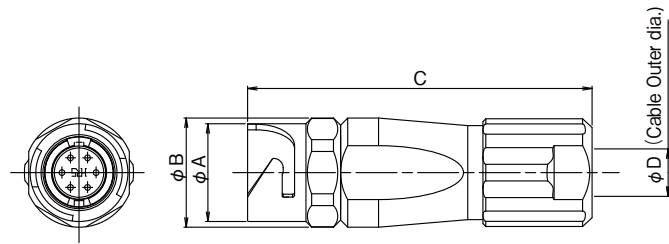

(Example of product appearance.)

Unit : mm

Part No.	HRS No.	Shell Size	No. of Pos.	ϕA	ϕB	C	ϕD	Weight	Purchase Unit
LF07WBJ-3P	CL0136-2003-8-00	LF07	3	10.3	11.5	36.3	5.0	11g	50pcs per tray
LF07WBJ-3S	CL0136-2004-0-00								
LF07WBJ-6P	CL0136-2001-2-00		6						
LF07WBJ-6S	CL0136-2002-5-00								
LF10WBJ-4P	CL0136-2005-3-00	LF10	4	12.8	13.8	42.4	7.3	16g	
LF10WBJ-4S	CL0136-2006-6-00								
LF10WBJ-12P	CL0136-2007-9-00		12						
LF10WBJ-12S	CL0136-2008-1-00								
LF13WBJ-11P	CL0136-2011-6-00	LF13	Hybrid 11pos. (Note)	15.9	16.9	52.4	8.7	29g	
LF13WBJ-11S	CL0136-2012-9-00							30g	
LF13WBJ-20P	CL0136-2009-4-00		20					29g	
LF13WBJ-20S	CL0136-2010-3-00							30g	

Note: Power 4pos. + Signal 7pos.

Crimping Type (Cat.6A)

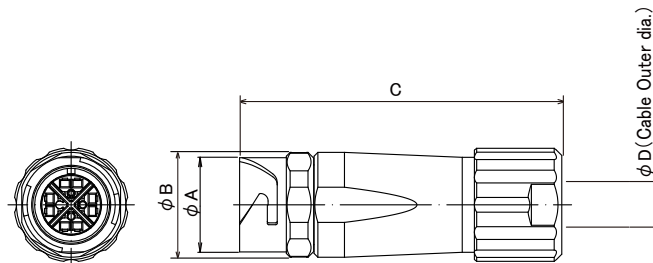

(Example of product appearance.)

Unit : mm

Part No.	HRS No.	Shell Size	No. of Pos.	ϕA	ϕB	C	ϕD	Weight	Purchase Unit
LF10WBJHA-8SC(40)	CL0136-0070-0-40	LF10	8	12.8	13.8	42.4	6.9	18g	50pcs per tray
LF10WBJHB-8SC(40)	CL0136-0073-0-40						6.5		

Crimp Contact

Male Contact

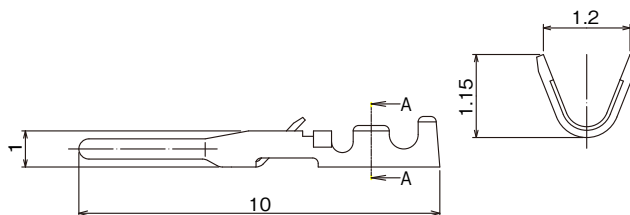

Type	Part No.	HRS No.	Applicable Connector	Applicable Cable	Purchase Unit
Loose Contact	HR10-PC-111	CL0110-0515-6-00	LF13WBP-20PC LF10WBR-12PC	26-30 AWG Outer Dia. ϕ 1 Max.	100pcs per bag
Reel Contact	HR10-PC-211	CL0110-0516-9-00	LF13WBRB-20PC		10,000pcs per reel

Note: The LF Series uses the contacts from the existing HR10 Series.

Male Contact (Cat.6A)

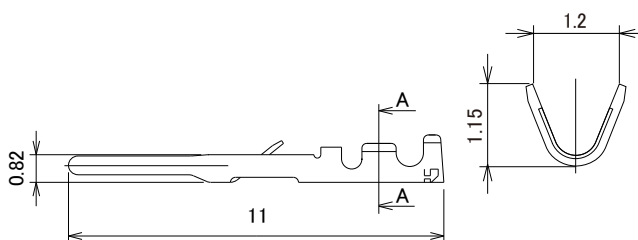

Type	Part No.	HRS No.	Applicable Connector	Applicable Cable	Purchase Unit
Loose Contact	HR30-PC-111	CL0130-0022-3-00	LF10WBPHA-8PC(40)	26-30 AWG Outer Dia. ϕ 1 Max.	100pcs per bag
Reel Contact	HR30-PC-211	CL0130-0016-0-00	LF10WBPHB-8PC(40)		10,000pcs per reel

Note: The LF Series uses the contacts from the existing HR30 Series.

Female Contact

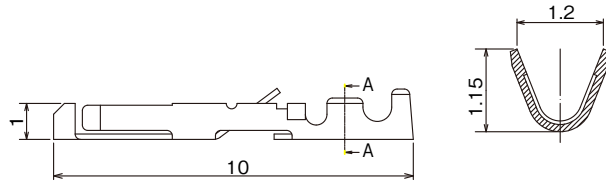

Type	Part No.	HRS No.	Applicable Connector	Applicable Cable	Purchase Unit
Loose Contact	HR12-SC-111	CL0112-0410-0-00	LF10WBP-12SC	26-30 AWG Outer Dia. ϕ 1 Max.	100pcs per bag
Reel Contact	HR12-SC-211	CL0112-0407-6-00	LF13WBP-20SC LF13WBRB-20SC		10,000pcs per reel

Note: The LF Series uses the contacts from the existing HR12 Series.

Female Contact (Cat.6A)

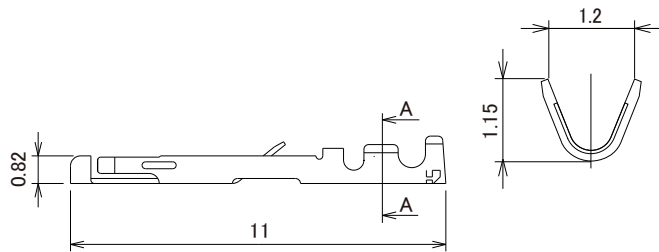

Type	Part No.	HRS No.	Applicable Connector	Applicable Cable	Purchase Unit
Loose Contact	HR30-SC-111	CL0130-0023-6-00	LF10WBJHA-8SC(40)	26-30 AWG Outer Dia. ϕ 1 Max.	100pcs per bag
Reel Contact	HR30-SC-211	CL0130-0017-3-00	LF10WBJHB-8SC(40)		10,000pcs per reel

Note: The LF Series uses the contacts from the existing HR30 Series.

Cap

Metal Receptacle Cap

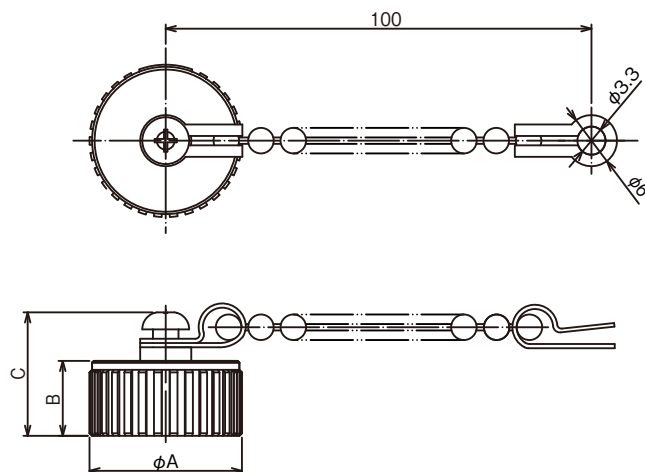

(Example of product appearance.)

Unit : mm

Type	Part No.	HRS No.	Applicable Connector	φ A	B	C	Weight	Purchase Unit
Without Chain	LF07WBR-C	CL0136-3008-7-00	LF07WBR-3P LF07WBR-3S LF07WBR-6P LF07WBR-6S LF07WBRB-6S LF07WBRB-3SD(31) LF07WBRB-6SD(31) LF07WBRB-6PD-A(31) LF07WBRB-6SD-A(31)	12.3	8.8		4g	20pcs per bag
	LF10WBR-C	CL0136-3001-8-00	LF10WBR-4P LF10WBR-4S LF10WBR-12P LF10WBR-12S LF10WBR-12PC LF10WBRB-4P LF10WBRB-4S LF10WBRB-12P LF10WBRB-12S LF10WBRB-12PD LF10WBRB-12SD LF10WBRB-8SD(40)	14.8			5g	
	LF13WBR-C	CL0136-3003-3-00	LF13WBR-11P LF13WBR-11S LF13WBR-20P LF13WBR-20S LF13WBR-20SD LF13WBRB-11P LF13WBRB-11S LF13WBRB-20P LF13WBRB-20S LF13WBRB-20SD LF13WBRB-20PC LF13WBRB-20SC	17.9			8.75	
With Chain	LF13WBR-C1	CL0136-3006-1-00	LF13WBR-11P LF13WBR-11S LF13WBR-20P LF13WBR-20S LF13WBR-20SD LF13WBRB-11P LF13WBRB-11S LF13WBRB-20P LF13WBRB-20S LF13WBRB-20SD LF13WBRB-20PC LF13WBRB-20SC	17.9	-	14.5	12g	

Mar.1.2026 Copyright 2026 HIROSE ELECTRIC CO., LTD. All Rights Reserved.

Rubber Receptacle Cap

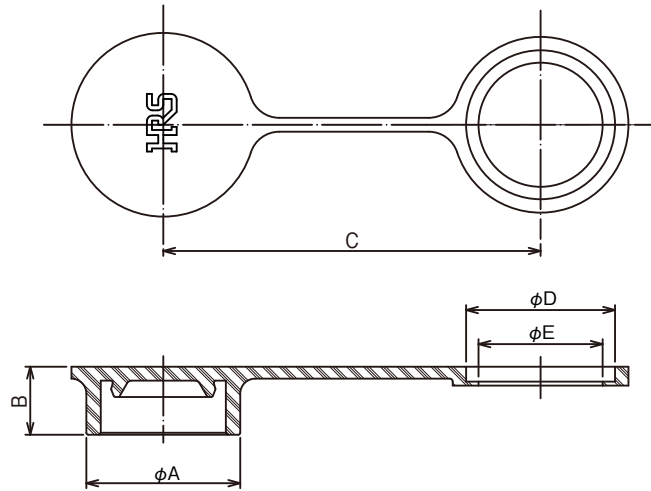

(Example of product appearance.)

Unit : mm

Part No.	HRS No.	Applicable Connector	ϕA	B	C	ϕD	ϕE	Weight	Purchase Unit
LF07WBR-C2	CL0136-3005-9-00	LF07WBR-3P LF07WBR-3S LF07WBR-6P LF07WBR-6S LF07WBRB-6S LF07WBRB-3SD(31) LF07WBRB-6SD(31) LF07WBRB-6PD-A(31) LF07WBRB-6SD-A(31)	13.0	6.55	38.0	10.0	-	1g	20pcs per bag
LF10WBR-C2	CL0136-3007-4-00	LF10WBR-4P LF10WBR-4S LF10WBR-12P LF10WBR-12S LF10WBR-12PC	15.5	6.85	38.0	15.0	12.5	2g	
LF13WBR-C2	CL0136-3011-0-00	LF13WBR-11P LF13WBR-11S LF13WBR-20P LF13WBR-20S LF13WBR-20SD LF13WBRB-11P LF13WBRB-11S LF13WBRB-20P LF13WBRB-20S LF13WBRB-20SD LF13WBRB-20PC LF13WBRB-20SC	18.6	6.55	40.0	15.5	-		

Applicable Tools

Termination Tools



(Example of product appearance.)

Part No.	HRS No.	Applicable Connector	Purchase Unit
LF07BP-T01	CL0150-0232-0-00	LF07WBP#-##	1pc per bag
LF07BJ-T01	CL0150-0233-3-00	LF07WBJ#-##	
LF10BP-T01	CL0150-0235-9-00	LF10WBP#-##	
LF10BJ-T01	CL0150-0236-1-00	LF10WBJ#-##	
LF13BP-T01	CL0150-0237-4-00	LF13WBP#-##	
LF13BJ-T01	CL0150-0238-7-00	LF13WBJ#-##	

Note 1: The applicable alphanumeric is added in place of ## based on the pin count. (Example: 6S)

Note 2: Use the termination tool as a base for termination or assembly.

Cable Crimp Tool

Item	Part No.	HRS No.	LF Series Applicable Cable Dia.
Manual Crimp Tool	HR10A-TC-02	CL0150-0041-2-00	φ 5mm (Note)
	LF-TC-01	CL0150-0234-6-00	φ 7.3mm · φ 8.7mm φ 6.5mm · φ 6.9mm

Note: Please note that while the applicable cable diameters for the HR10A-TC-02 crimp tool are φ 5mm and φ 7mm, the applicable cable diameter of the LF Series is φ 5mm only.

Crimp Contact Tool

Item	Type	Part No.	HRS No.	Applicable Contact	Applicable Cable
Automatic	Automatic Crimp Press	CM-105C	CL0901-0001-0-00	-	-
	Applicator	AP105-HR12-1	CL0901-2015-9-00	HR10-PC-211 HR12-SC-211	26-30 AWG Outer Dia. φ 1 Max.
		AP105-HR30-1	CL0901-2049-0-00	HR30-PC-211 HR30-SC-211	26-30 AWG Outer Dia. φ 1 Max.
Manual	Manual Crimp Tool	HT802/HR12-SC-1	CL0150-0400-3-00	HR10-PC-111 HR12-SC-111	26-30 AWG Outer Dia. φ 1 Max.
		HT102/HR30-1	CL0150-0229-6-00	HR30-PC-111 HR30-SC-111	26-30 AWG Outer Dia. φ 1 Max.
Contact Extraction Tool		RP6-SC-TP	CL0150-0039-0-00	HR10-PC-211 HR10-PC-111	-
		HR12-SC-TP	CL0150-0050-3-00	HR12-SC-211 HR12-SC-111	-
		HR30-TP	CL0150-0219-2-00	HR30-PC-211 HR30-PC-111 HR30-SC-211 HR30-SC-111	-

Note 1: Please conduct crimping work according to the Crimp Quality Standard and Crimp Conditions.

Note 2: Problems with tools other than those specified by Hirose are outside the scope of warranty.

Note 3: Applicable Cable and contacts are limited to those listed in the table.

Please refer to the Crimp Conditions for applicable cable core wire configuration. The Crimp Conditions are available from Part No. link.
(If you are using a cable that is not listed in Crimp Condition, please contact a Hirose sales representative.)

Panel Cut-Out Dimensions

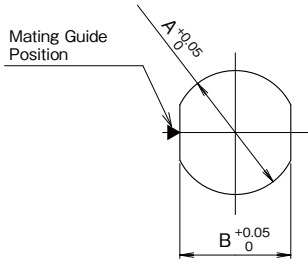

Unit : mm

Type	Shell Size	Applicable Connector	ϕ A	B	Panel Thickness
Front Mount	LF07	LF07WBR#-##	9.05	8.1	0.7 to 2.0
	LF10	LF10WBR#-##	11.05	10.2	
	LF13	LF13WBR#-##	14.05	13.1	
Rear Mount	LF07	LF07WBRB#-##	11.05	10.5	0.7 to 4.0
	LF10	LF10WBRB#-##	14.05	13.1	0.7 to 2.0
	LF13	LF13WBRB#-##	17.05	16.1	0.7 to 4.8

Note: The applicable alphanumeric is added in place of ## based on the pin count. (Example: 6S)

Contact Arrangement and Main Specifications

Shell Size	LF07		LF07-A	
Contact Arrangement				
No. of Pos.	3	6	Power/Signal Hybrid 6pos.	
Withstanding Voltage	1,250V AC	300V AC	300V AC	
Current Rating	5A	2A	Power 2pos. 4A	Signal 4pos. 1A
Insulation Resistance	1,000M Ω			
Contact Resistance	15m Ω			
Solder Pot Inner Diameter	φ 1.15	φ 0.8	Power 2pos. φ 1.15	Signal 4pos. φ 0.8

Shell Size	LF10			LF13		
Contact Arrangement						
No. of Pos.	4	8	12	Hybrid 11pos.		20
Withstanding Voltage	1,250V AC	1,000V AC	300V AC	Power 4pos. 1,250V AC	Signal 7pos. 300V AC	300V AC
Current Rating	10A	2A	2A	Power 4pos. 10A	Signal 7pos. 2A	2A
Insulation Resistance	1,000M Ω	100M Ω	1,000M Ω			
Contact Resistance	5m Ω	Signal 30m Ω Shield 30m Ω	15m Ω	Power 4pos. 5m Ω	Signal 7pos. 15m Ω	15m Ω
Solder Pot Inner Diameter	φ 1.7	-	φ 0.8	Power 4pos. φ 1.7	Signal 7pos. φ 0.8	φ 0.8

Note 1: The contact arrangements are from the view of the female contact connector mating face.

Note 2: The ▼ symbol in the above diagrams indicates the mating guide position.

Note 3: The withstanding voltage values in the above tables are tested values.

Cable Specifications (Reference)

No. of Pos.		3pos.	4pos.	6pos.	12pos.	20pos.	11pos.	
Conductor	Material	Tin Plated Soft Copper Wire						
	Size (mm)	φ 0.18	φ 0.26	φ 0.16	φ 0.16	φ 0.16	φ 0.26	φ 0.16
	Construction	20 / φ 0.18	20 / φ 0.26	7 / φ 0.16	7 / φ 0.16	7 / φ 0.16	26 / φ 0.26	7 / φ 0.16
	Size (AWG)	20	16	26	26	26	16	26
	Sectional Area (mm ²)	0.5	1.25	0.14	0.14	0.14	1.25	0.14
	Diameter (mm)	φ 0.98	φ 1.5	φ 0.48	φ 0.48	φ 0.48	φ 1.5	φ 0.48
Insulator	Diameter (mm)	φ 1.5 (Standard)	φ 2.1	φ 0.88 (Standard)	φ 0.9	φ 0.9	φ 2.1	φ 0.95
	Thickness (mm)	0.26	0.3	0.2	0.21	0.21	0.3	0.24
Shield	Material	Tin Plated Soft Copper Wire						
	Density (%)	85%	80% Min.	85%	80% Min.	80% Min.	80% Min.	
	Diameter (mm)	φ 3.6	φ 5.5	φ 3.4	φ 4.2	φ 5.1	φ 6.7	
Jacket	Diameter (mm)	φ 5 ± 0.2	φ 7.3 ± 0.2	φ 5 ± 0.2	φ 7.3 ± 0.2	φ 8.7 ± 0.2	φ 8.7 ± 0.2	

Note 1: The cable specifications in the above table satisfy UL requirements.

Note 2: Use a cable without empty space inside. If there is empty space in the cable, clamping and waterproof performance may not be maintained.

8pos. (Cat.6A) Cable

Cable Supplier	Product Name	Conductor				Insulator	Sheath			
		Wire type	Size		Structure		Outer dia. (mm)	Outer dia. (mm)	Material	Outer dia. (mm)
			AWG	sq						
Nippon Seisen Cable	4P NSGDT6-PC-10G-SB	Stranded	26	0.12	7/ 0.17	φ 0.51	φ 0.90	PVC	φ 6.3	Blue
Quabbin	4PR. SF/UTP HIGH FLEX INDUSTRIAL ETHERNET/IP PATCH CORD -- CATEGORY 6/6a	Stranded	26	0.14	7/ 0.16	φ 0.48	φ 0.91	Thermoplastidc elastomer	φ 7.0	Teal
Taiyo Cabletec Corporation	TCAPTC-17005 FAFX-6A26SLAB(BK) 4P × 26AWG	Stranded	26	0.16	7/ 0.17	φ 0.46	φ 0.84	Flame retardant lead free PVC	φ 6.5	Black

Connector Usage Precautions

- When assembling the connector and installing to equipment, refer to the separate procedure manual and drawings. Please also make sure to use the specified tightening torque. If the torque is too low or high, it may result in loosening or product damage. In order to prevent loosening, apply Locktight 263 manufactured by Henkel Japan Ltd., Tokyo at the male screw. (Contact a Hirose sales representative for the procedure manual.)
- Once mated, pull lightly on the cable to confirm the mated status and that the connector does not come off.
- Excessive external force applied to the connector may cause deformation or damage, resulting in poor conduction or waterproofing performance issues. Please avoid forceful insertion/removal, impact and pulling, routing or twisting of the cables. Also, when routing inside equipment, make sure to provide sufficient slack to the cable so that a load is not applied directly to the connector such as through excessive cable bending or tension on the cable.
- Damage of the waterproof seal or waterproof surface may result in issues with the waterproof performance, so please refrain from using a damaged product.

While Taking into Consideration

Specifications mentioned in this catalog are reference values.

When considering to order or use this product, please review the Drawing and Product Specifications sheets.

Use an appropriate cable when using the connector in combination with cables.

If considering usage of a non-specified cable, please contact your sales representative.

If assembly process is done by jigs & tools which are not identified by Hirose, assurance will not be given.

If considering usage for below mentioned applications, please contact your sales representative.

In cases where the application will demand a high level of reliability, such as automotive, medical instruments, public infrastructure, aerospace/ defense etc. Hirose must review before assurance of reliability can be given.

HIROSE**HIROSE ELECTRIC CO.,LTD.**2-6-3 Nakagawa Chuoh, Tsuzuki-Ku, Yokohama-Shi 224-8540, JAPAN
<https://www.hirose.com>