

MRF14 Series

Non-Magnetic, Long-Life Connector

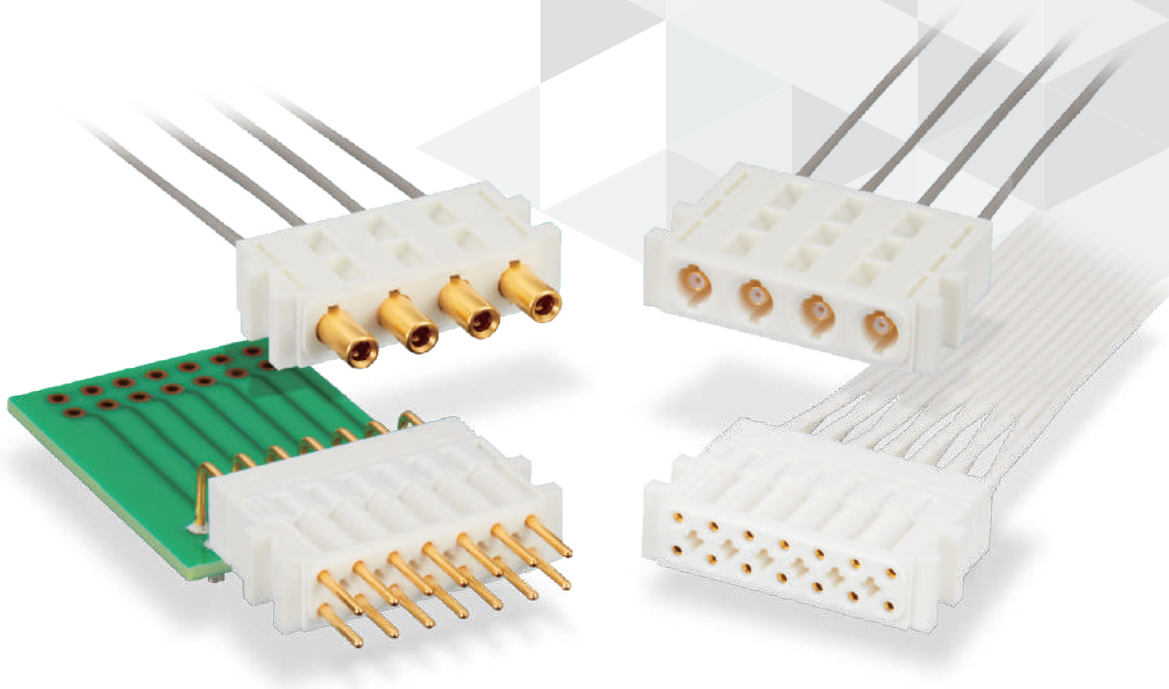

Nov. 1.2024 Copyright 2024 HIROSE ELECTRIC CO., LTD. All Rights Reserved.



Overview

MRF14 Series is a non-magnetic, long-life connector designed for MRI and testing equipment. With its excellent mating durability of 60,000 times, this multi-positional connector is suitable for various applications. Both coaxial and signal types are available.

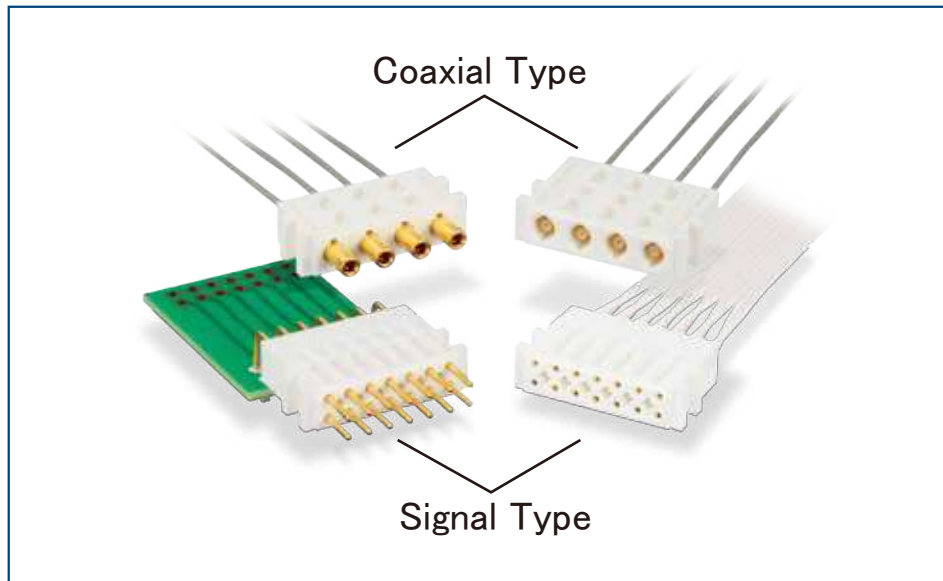

Features

● Whole Series

1. Non-Magnetic
2. Long-Life
(Mating Durability : 60,000 times)

● Coaxial Type

1. Available in 4, 8pos. Housing

4, 8pos. Housings for plugs and jacks are sold separately.

2. High Impedance Matching

Excellent High Frequency Characteristics :
Up to 0.5GHz, V.S.W.R. 1.3 Max.
0.5 to 1GHz, V.S.W.R. 1.5 Max.

3. Easy Insertion and Removal, Low Insertion and Removal Force

Plug-in mating for easy insertion and removal.
Insertion force of 1.5N Max. and extraction force
of 0.15N Min. per pin.

● Signal Type

1. 14pos. Housing

14 pos. Housing (same for Male and Female) is
sold separately.

2. Compact and Lightweight Design

Male Contact: 2.09mm outer diameter,
approximately 0.35 to 0.62g per pin.
Female Contact: 2.04mm outer diameter,
approximately 0.18g per pin.

3. Support for Through-Hole Mounting and In-Line Cable Harness

The male contact supports right-angle through-
hole mounting and in-line cable harnessing.
The female contact is designed for in-line cable
harnessing.

Product Specifications

● Coaxial Type

Characteristic Impedance	50 Ω	Operating Temperature	-40 to +85°C
Frequency	0 to 1GHz	Operating Relative Humidity	90% Max.

Item	Standards	Condition
Contact Resistance	30m Ω Max. (Center) 30m Ω Max. (External)	Measured at 100mA Max.
Insulation Resistance	500M Ω Min.	Measured at 500V DC
Withstanding Voltage	No dielectric breakdown	500V AC for 1 min.
V.S.W.R.	1.3 Max. 1.5 Max.	0 to 0.5GHz 0.5 to 1GHz
Retention Force of Female Contact	0.05N Min.	Measured with ϕ 0.4826 steel pins
Insertion/Extraction Force	Insertion Force : 1.5N Max. Extraction Force 0.15N Min.	Measure with a compatible connector.
Mating Durability	Contact Resistance : 60m Ω Max. (Center) 60m Ω Max. (External) No broken, cracked, or loose parts.	60,000 times
Vibration Resistance	No electrical discontinuity of 1 μ s or more No broken, cracked, or loose parts.	Frequency 10 to 500Hz, Half amplitude 0.75mm, Acceleration 98m/s ² 10 cycles in each of the 3 axis
Humidity Resistance	Insulation Resistance : 10M Ω Min. (in a high humidity environment) Insulation Resistance : 500M Ω Min. (in a dry environment) No broken, cracked, or loose parts.	Temperature +40°C , Humidity 95%, Left for 96 hours
Temperature Cycle	No broken, cracked, or loose parts.	Temperature: -55°C to +20 to +35°C to +85°C to +20 to +35°C Time: 30 min. -- > within 5 min. -- > 30 min. -> within 5 min. 5 cycles
Salt Spray	No considerable corrosion.	Continuous 48 hour cycle in 5% salt water solution

Note: Information contained in this catalog represents general requirements for this Series.
Contact us for the drawings and specifications for a specific part number shown.

● Signal Type

Rated Current	2A DC	Operating Temperature	-40 to +85°C
Rated Voltage	500V AC	Operating Relative Humidity	90% Max.

Item	Standards	Condition
Contact Resistance	30m Ω Max.	Measured at 100mA Max.
Insulation Resistance (Note)	500M Ω Min.	Measured at 500V DC
Withstanding Voltage (Note)	No dielectric breakdown	1,500V AC for 1 min.
Female Contact Retention Force	0.02N Min.	Measured with applicable connector
Mating Durability	Contact Resistance : 60m Ω Max. No broken, cracked, or loose parts.	60,000 times
Vibration Resistance	No electrical discontinuity of 1 μ s or more No broken, cracked, or loose parts.	Frequency 10 to 500Hz, Half amplitude 0.75mm, Acceleration 98m/s ² 10 cycles in each of the 3 axis
Humidity Resistance	Insulation Resistance : 10M Ω Min. (in a high humidity environment) Insulation Resistance : 500M Ω Min. (in a dry environment) No broken, cracked, or loose parts.	Temperature +40°C , Humidity 95%, Left for 96 hours
Temperature Cycle	No broken, cracked, or loose parts.	Temperature: -55°C → +20 to +35°C → +85°C → +20 to +35°C Time: 30 min. → within 5 min. → 30 min. → within 5 min. 5 cycles
Salt Spray	No considerable corrosion.	Continuous 48 hour cycle in 5% salt water solution.

Note 1 : Measured when mounted in housing.

Note 2 : Information contained in this catalog represents general requirements for this Series.
Contact us for the drawings and specifications for a specific part number shown.

Materials / Finish

● Coaxial Type

Component	Material	Finish
Shell	Phosphorous Bronze	Gold Plating
Center Male Contact	Phosphorous Bronze	Gold Plating
Center Female Contact	Beryllium Copper	Gold Plating
Insulator	PTFE	-
Crimp Sleeve	Phosphorous Bronze	Non-Magnetic Nickel Plating
Heat Shrink Tube	Polyolefin	-
Housing	PBT	-

● Signal Type

Component	Material	Finish
Contact	Beryllium Copper	Gold Plating
Outer Tube	Phosphorous Bronze	Gold Plating
Male Contact	Beryllium Copper Phosphorous Bronze	Gold Plating
Female Contact	Beryllium Copper	Gold Plating
Housing	PBT	-

Product Number Structure

Refer to the chart below when determining the product specifications from the product number.
Please select from the product numbers listed in this catalog when placing orders.

■ Coaxial Type

MRF14 - [] - 088 NM - 1

① ② ③

① Series Name	MRF14	③ Compatible Cable	088 : ϕ 1.37 Flexible Coaxial Cable
② Connector Type	P : Straight Plug J : Straight Jack		

■ Signal Type

MRF14 - CON ([])

① ② ③

① Series Name	MRF14	③ Connector Type	MC : Male (In-Line Cable Harness Type) M1, M2 : Male (Through-Hole Mounting Type) F : Female (In-Line Cable Harness Type)
② CON	Signal Contact		
		④ Compatible Cable	24 AWG

Functional Diagram

● Coaxial Type

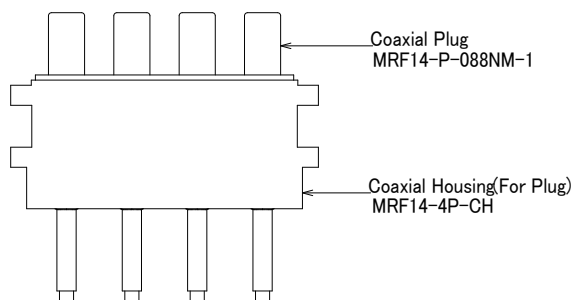
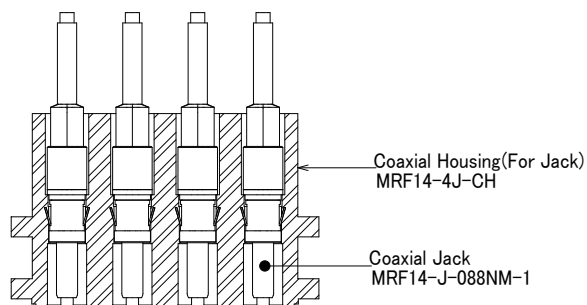

Note : Coaxial housing is also available for 8pos.

● Signal Type

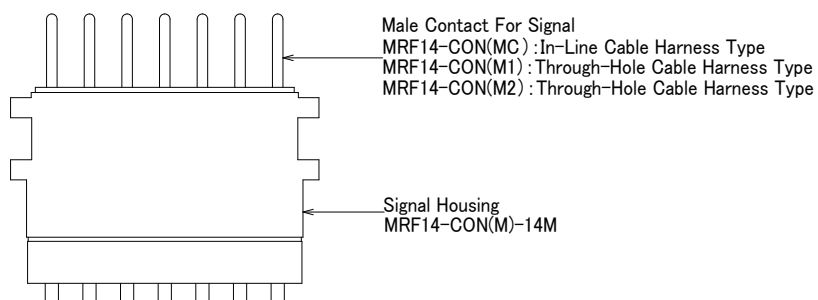
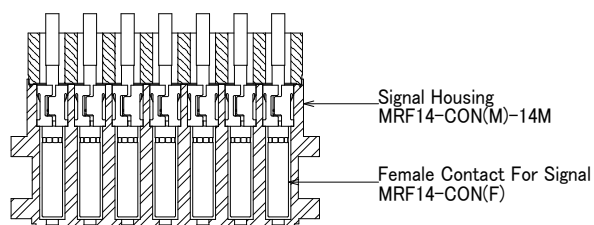

Coaxial Straight Plug

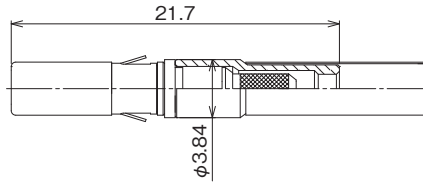

Part No.	HRS No.	Purchase Unit
MRF14-P-088NM-1	CL0313-0714-8-00	20pcs per bag

Coaxial Straight Jack

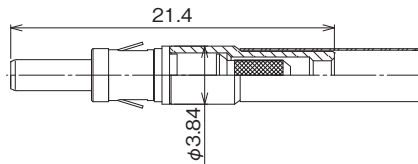

Part No.	HRS No.	Purchase Unit
MRF14-J-088NM-1	CL0313-0715-0-00	20pcs per bag

Coaxial Housing (for 4pos. Coaxial Plug)

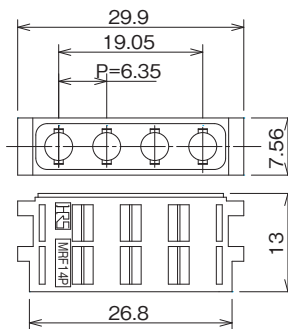

Part No.	HRS No.	Purchase Unit
MRF14-4P-CH	CL0313-0707-2-00	20pcs per bag

Coaxial Housing (for 4pos. Coaxial Jack)

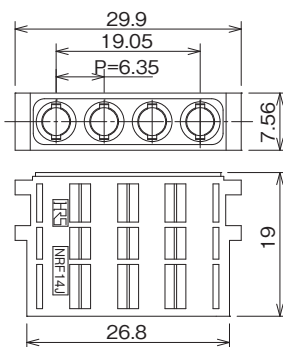

Part No.	HRS No.	Part No.
MRF14-4J-CH	CL0313-0708-5-00	20pcs per bag

Coaxial Housing (for 8pos. Plug)

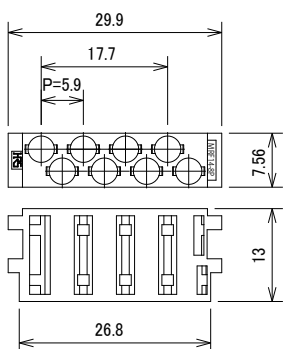

Part No.	HRS No.	Purchase Unit
MRF14-8P-CH	CL0313-0721-3-00	20pcs per bag

Coaxial Housing (for 8pos. Jack)

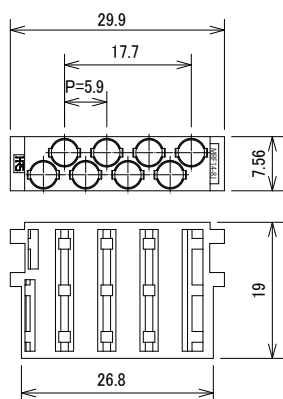

Part No.	HRS No.	Purchase Unit
MRF14-8J-CH	CL0313-0722-6-00	20pcs per bag

Signal Male Contact (In-Line Cable Harness Type)

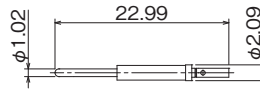

Part No.	HRS No.	Purchase Unit
MRF14-CON(MC)	CL0313-0716-3-00	20pcs per bag

Signal Male Contact (Through-Hole Mounting Type)

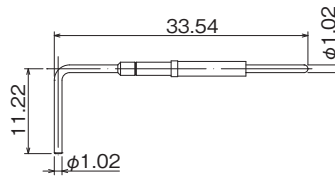
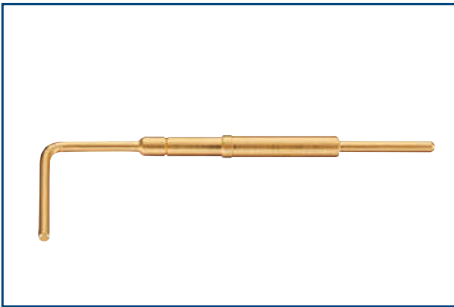

Part No.	HRS No.	Purchase Unit
MRF14-CON(M1)	CL0313-0710-7-00	20pcs per bag

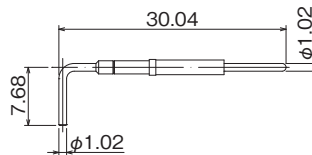
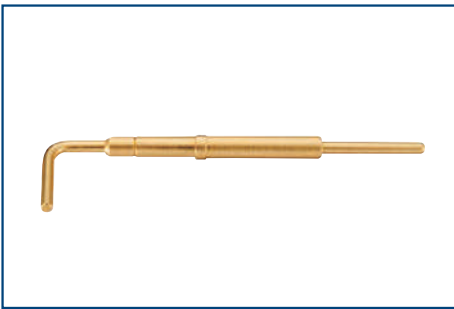

Part No.	HRS No.	Purchase Unit
MRF14-CON(M2)	CL0313-0711-0-00	20pcs per bag

Signal Female Contact (In-Line Cable Harness Type)

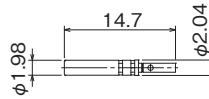

Part No.	HRS No.	Part No.
MRF14-CON(F)	CL0313-0709-8-00	20pcs per bag

Housing (For Signal, 14pos. Both Male and Female)

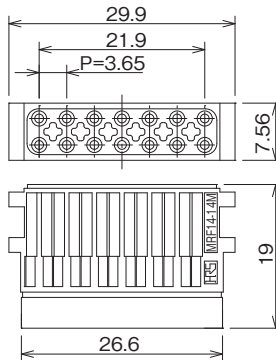

Part No.	HRS No.	Purchase Unit
MRF14-CON(M)-14M	CL0313-0706-0-00	10pcs per box

Male Contact (Through-Hole Mounting Type)

PCB Hole Dimensions (Male Contact Through-Hole Mounting Type)

Mounted in Housing

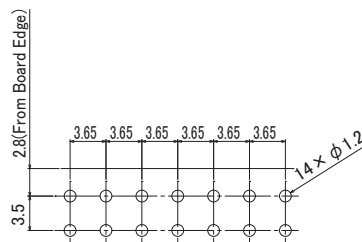
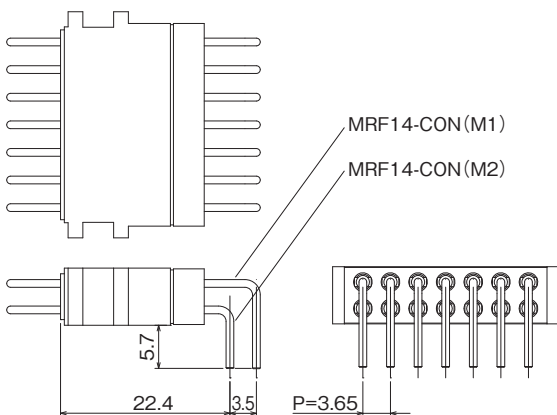

Mounted Connector Diagram

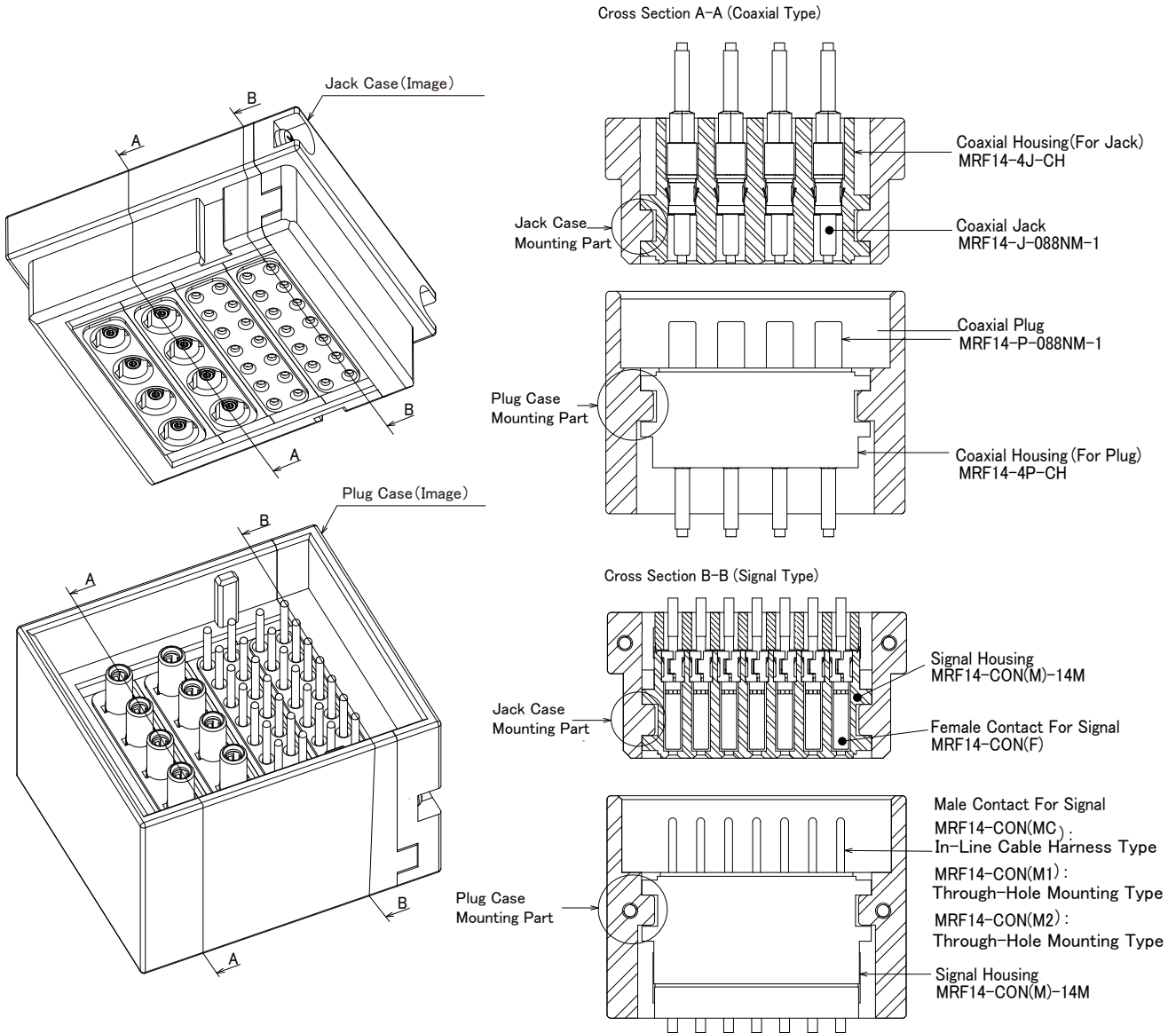

Note : Lock and guide pin are purchased separately. Contact a Hirose sales representative for installation details and dimensions.

Cable Type

Part No.	Compatible Cable
MRF14-P-088NM-1	φ 1.37 Flexible Coaxial Cable
MRF14-J-088NM-1	φ 1.37 Flexible Coaxial Cable
MRF14-CON(MC)	24 AWG
MRF14-CON(F)	24 AWG

Applicable Tool

Item	Part No.	Compatible Connector
Cable Crimping Tool	HT702/MRF14-088	MRF14-P-088NM-1
		MRF14-J-088NM-1
	HT901/MRF14-CON	MRF14-CON(MC)
		MRF14-CON(F)

While Taking into Consideration

Specifications mentioned in this catalog are reference values.

When considering to order or use this product, please review the Drawing and Product Specifications sheets.

Use an appropriate cable when using the connector in combination with cables.

If considering usage of a non-specified cable, please contact your sales representative.

If assembly process is done by jigs & tools which are not identified by Hirose, the warranty of the product may be affected.

If considering usage for below mentioned applications, please contact your sales representative.

In cases where the application will demand a high level of reliability, such as automotive, medical instruments, public infrastructure, aerospace/defense etc. Hirose must review before assurance of reliability can be given.

HIROSE



HIROSE ELECTRIC CO.,LTD.

2-6-3 Nakagawa Chuoh, Tsuzuki-Ku, Yokohama-Shi 224-8540, JAPAN
<https://www.hirose.com>

※ The contents of this catalog are current as of date of 1/2024. Contents are subject to change without notice for the purpose of improvements.

※ The HRS logo and "HIROSE" are trademarks of HIROSE ELECTRIC CO., LTD.