

Oct.1.2022 Copyright 2022 HIROSE ELECTRIC CO., LTD. All Rights Reserved.
In case of consideration for using Automotive equipment / device which demand high reliability, kindly contact our sales window correspondents.

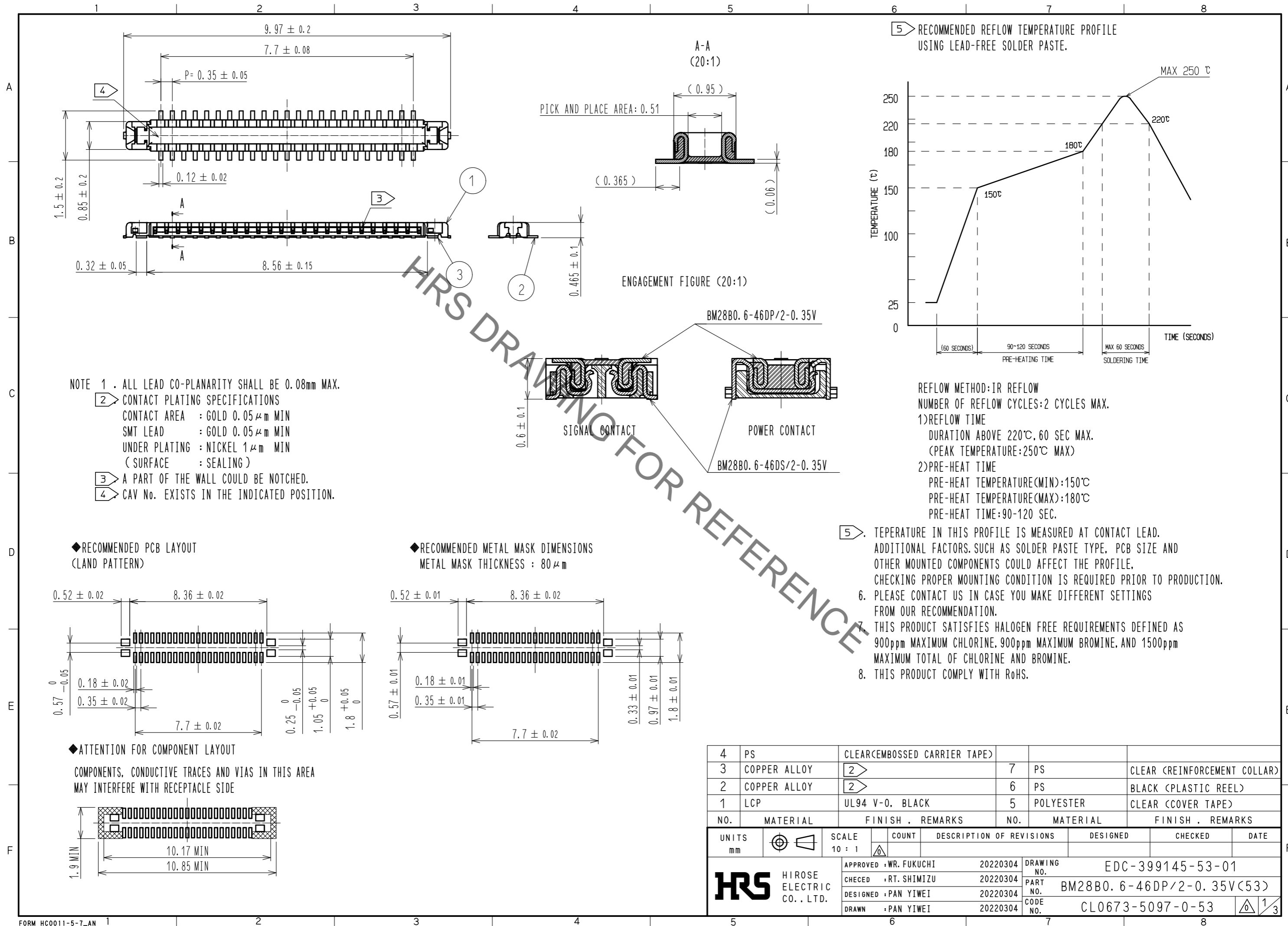

- NOTE 1 . ALL LEAD CO-PLANARITY SHALL BE 0.08mm MAX.
- 2 CONTACT PLATING SPECIFICATIONS
CONTACT AREA : GOLD 0.05 μm MIN
SMT LEAD : GOLD 0.05 μm MIN
UNDER PLATING : NICKEL 1 μm MIN
(SURFACE : SEALING)
 - 3 A PART OF THE WALL COULD BE NOTCHED.
 - 4 CAV No. EXISTS IN THE INDICATED POSITION.

◆RECOMMENDED PCB LAYOUT (LAND PATTERN)

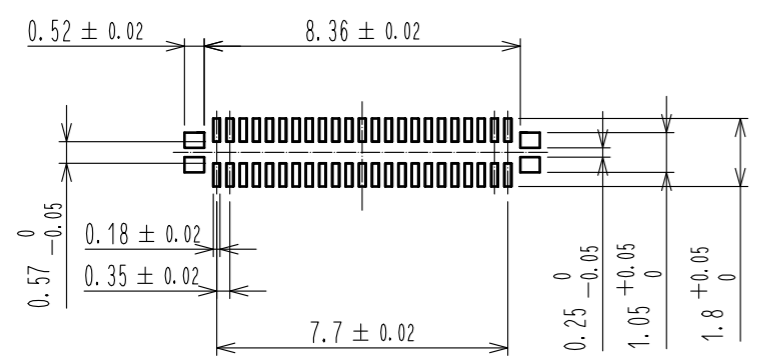

◆RECOMMENDED METAL MASK DIMENSIONS
METAL MASK THICKNESS : 80 μm

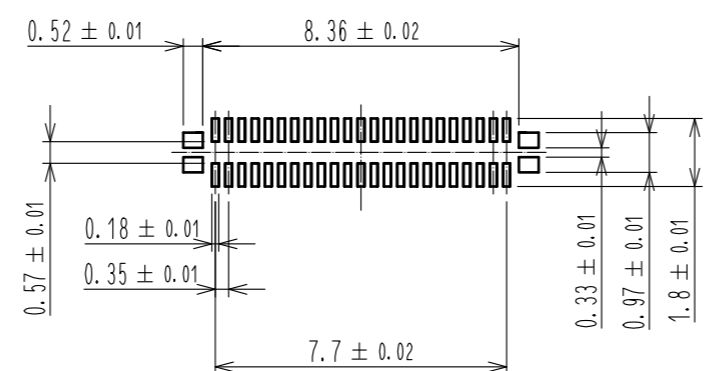

◆ATTENTION FOR COMPONENT LAYOUT

COMPONENTS, CONDUCTIVE TRACES AND VIAS IN THIS AREA MAY INTERFERE WITH RECEPTACLE SIDE

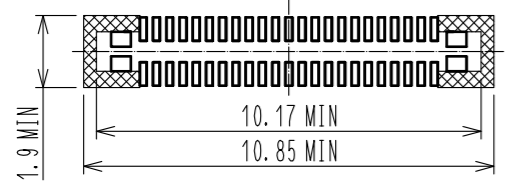

4	PS	CLEAR(EMBOSSED CARRIER TAPE)			
3	COPPER ALLOY	2	7	PS	CLEAR (REINFORCEMENT COLLAR)
2	COPPER ALLOY	2	6	PS	BLACK (PLASTIC REEL)
1	LCP	UL94 V-0, BLACK	5	POLYESTER	CLEAR (COVER TAPE)
NO.	MATERIAL	FINISH . REMARKS	NO.	MATERIAL	FINISH . REMARKS
UNITS mm	①	SCALE 10 : 1	△	COUNT	DESCRIPTION OF REVISIONS
DESIGNED		CHECKED		DATE	
APPROVED : WR. FUKUCHI 20220304			DRAWING NO. EDC-399145-53-01		
CHECED : RT. SHIMIZU 20220304			PART NO. BM28B0. 6-46DP/2-0. 35V(53)		
DESIGNED : PAN YIWEI 20220304			CODE NO. CL0673-5097-0-53		
DRAWN : PAN YIWEI 20220304			1/3		

Oct.1.2022 Copyright 2022 HIROSE ELECTRIC CO., LTD. All Rights Reserved.
 In case of consideration for using Automotive equipment / device which demand high reliability, kindly contact our sales window correspondents.

EMBOSED CARRIER TAPE PACKAGING (5:1)

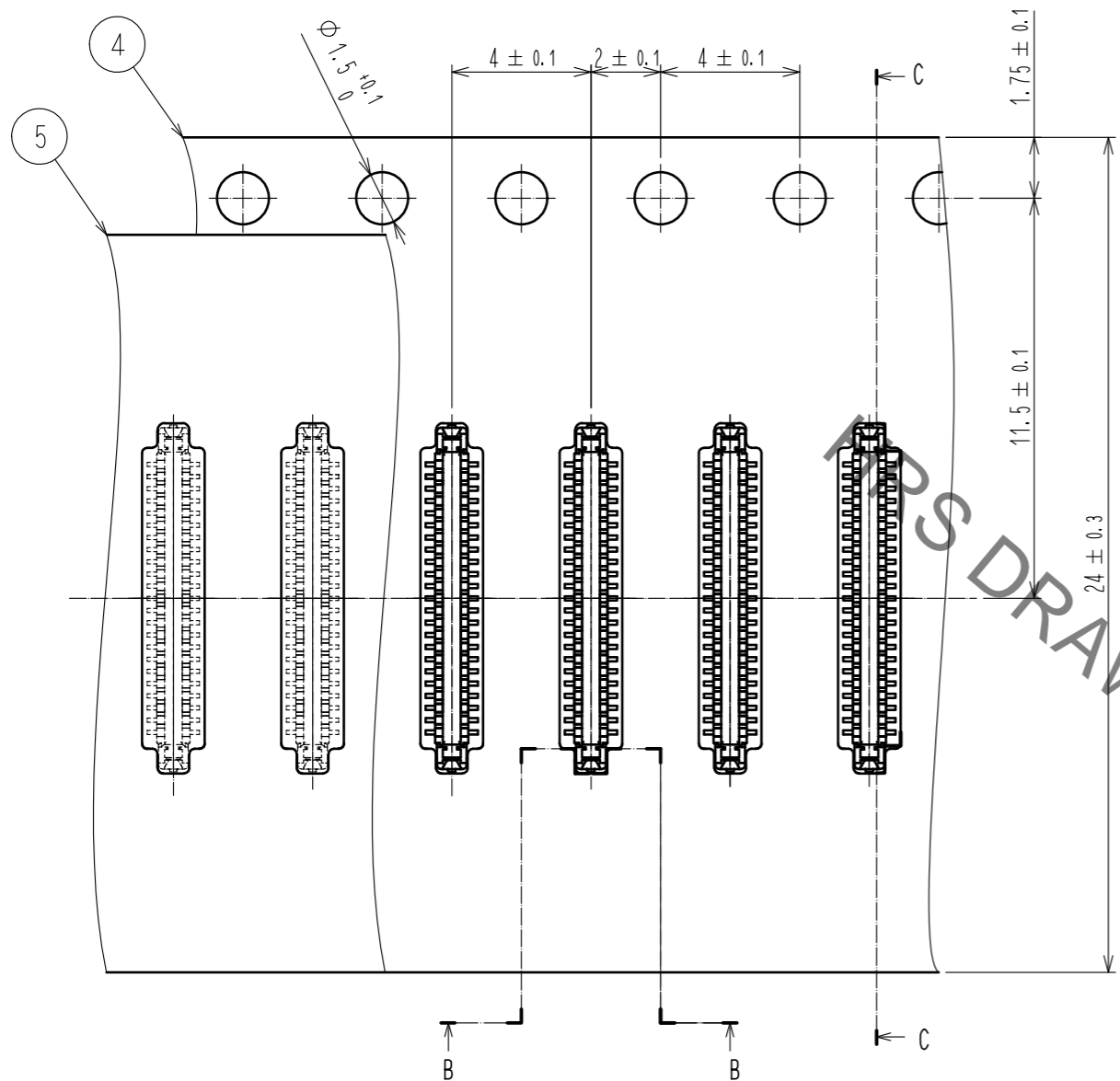

C-C (5:1)

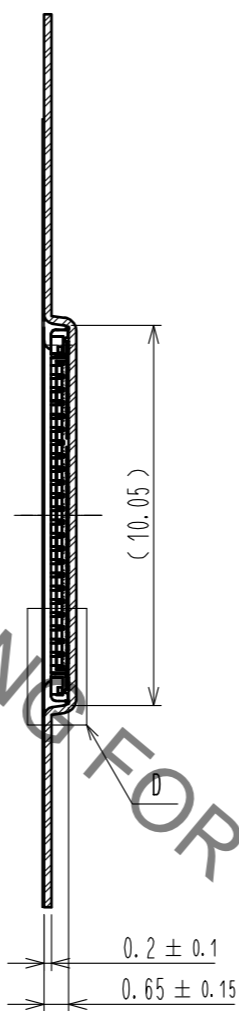

STYLE AND DIMENSION OF REEL (FREE)

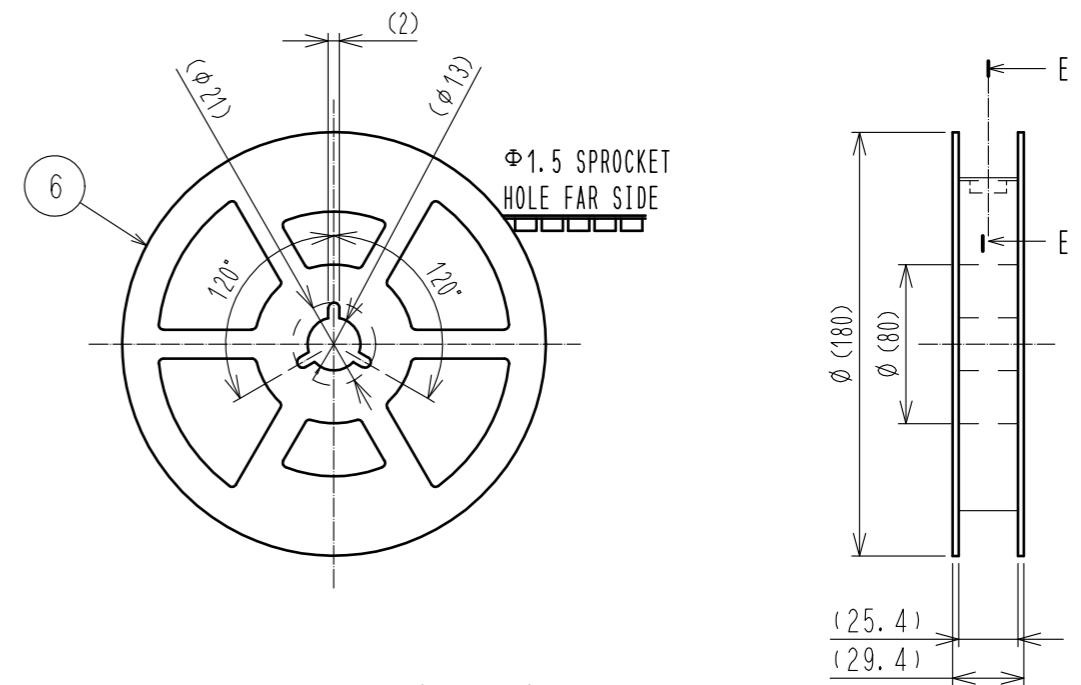

E-E (FREE)

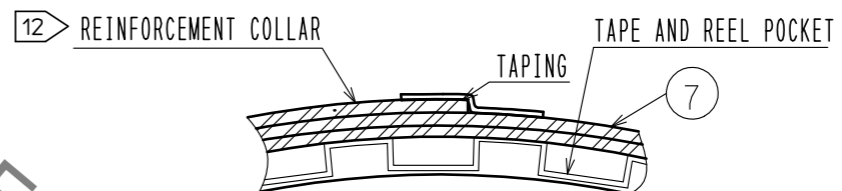

B-B (5:1)

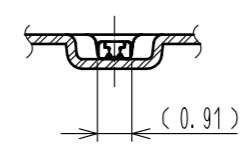

DIRECTION OF UNREELING

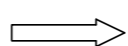

D (10:1)

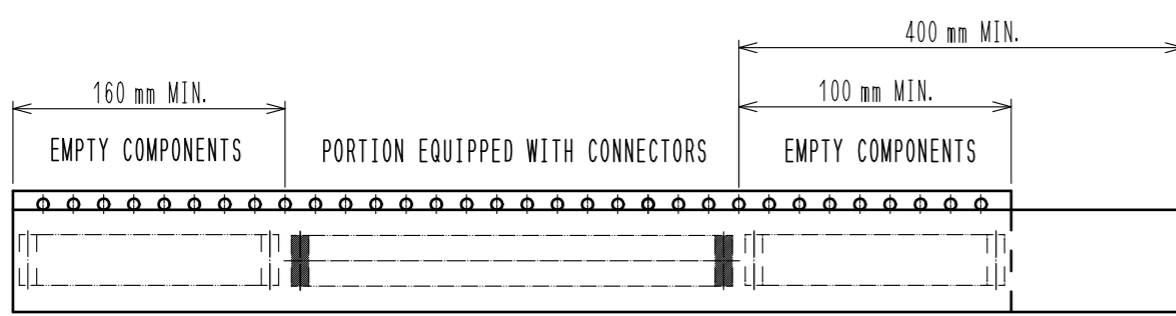
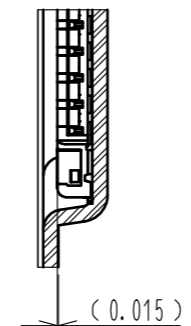

11 TAPING(FREE)

- 9. PER REEL 1,000 CONNECTORS.
- 10. THE DIMENSIONS IN PARENTHESES ARE FOR REFERENCE.
- 11. REFER TO JIS C 0806 (PACKAGING OF COMPONENTS FOR AUTOMATIC HANDLING)
- 12. AFTER PACKAGING, ROLL 2 METERS OF THE REINFORCEMENT COLLAR TO OUTER CIRCUMFERENCE OF TAPE AND REEL POCKET, AND TAPE DOWN AT THE END THE COLLAR.

HRS	DRAWING NO.	EDC-399145-53-01	
	PART NO.	BM28B0. 6-46DP/2-0. 35V(53)	
	CODE NO.	CL0673-5097-0-53	\triangle 2/3

13. PLEASE REFER TO THE PRODUCT GUIDELINE ETAD-H1016 FOR DETAIL OF CONNECTOR HANDLING.

THE POSITION BETWEEN THE CONNECTOR AND PAD

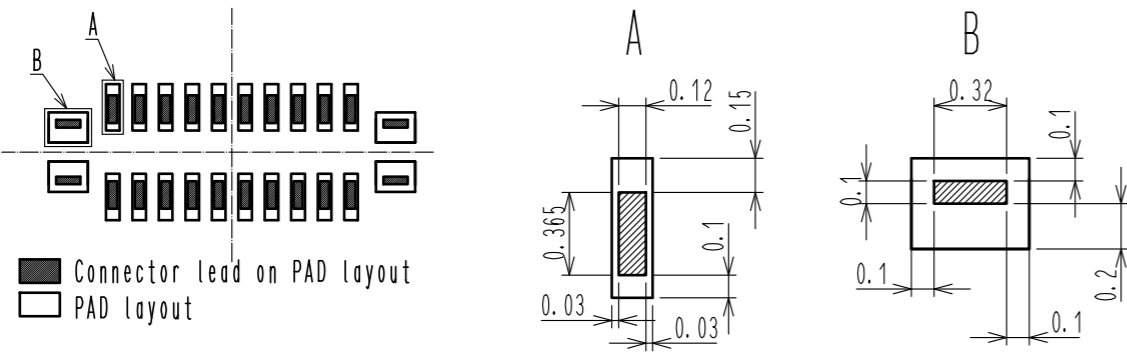

MATING METHOD

PLEASE MATE THE CONNECTOR BY HAND.

MATING PROCEDURE

- FIND THE ALIGNMENT AREA TO THE CONNECTOR IN THE APPROPRIATE MATING POSITION. THIS CONNECTOR HAS AN ALIGNMENT CHAMBER(GUIDANCE RIBS) ON RECEPTACLE SIDE AND 'R' ON PLUG SIDE. SO THAT THE CONNECTOR WILL BE SELF-ALIGNED. WHEN THE CONNECTOR COMES TO THE APPROPRIATE POSITION, THE CONNECTOR GOES INTO THE ALIGNED POSITION. WHEN ALIGNED, IT CAN BE FELT BY HAND.

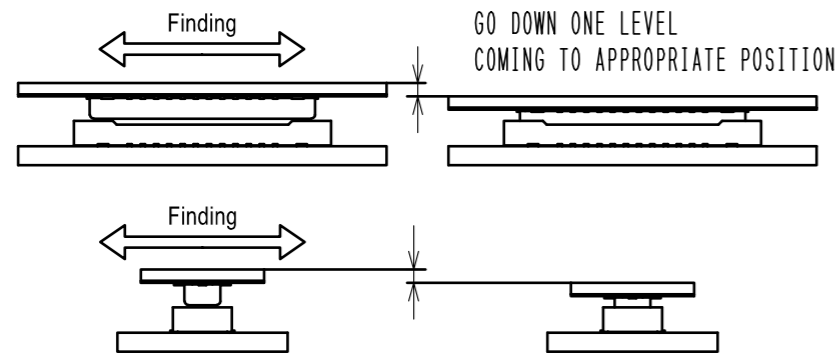

- WHEN GUIDING, THE CONNECTORS ARE ALIGNED PARALLEL TO EACH OTHER, WITH LONGITUDINAL AND LATERAL MOVEMENTS RESTRICTED. MATE THEM PROPERLY BY APPLYING FORCE IN THIS CONDITION.



- MAKE SURE THE CONNECTORS ARE MATED CORRECTLY. IF ONE SIDE IS FLOATING OR THE CONNECTORS ARE MATED IN ONE DIRECTION, UN-MATE THEM ONCE, AND THEN MATE THEM AGAIN, FOLLOWING THE PROCEDURES ABOVE FROM THE BEGINNING.

UN-MATING METHOD

PLEASE UN-MATE THE CONNECTOR BY HAND

- UN-MATE THE CONNECTORS PARALLEL TO EACH OTHER. HOWEVER, IF THE CONNECTORS HAVE HIGH PIN COUNTS OR THINNER FPC AND STIFFENER, IT BECOMES MORE DIFFICULT TO DO SO.

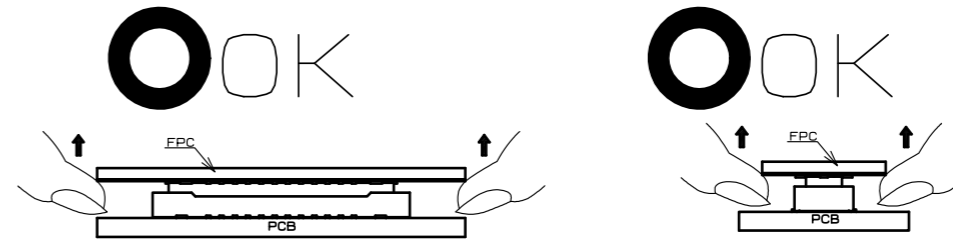

- IF THE CONNECTOR CANNOT BE UN-MATED PARALLEL IT CAN BE REMOVED DIAGONALLY FROM THE PITCH DIRECTION. BE CAREFUL TO DO SO SINCE THIS ACTION APPLIES STRESS ON THE CONTACT.

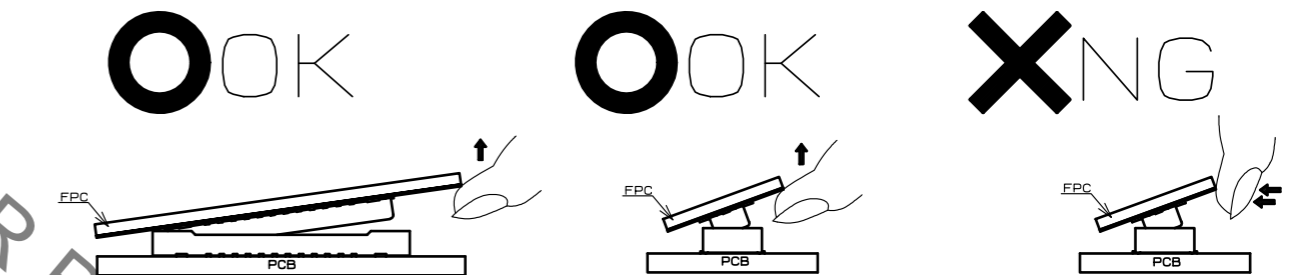

- IF THE FPC IS NOT RIGID, THE CONNECTOR CAN BE BROKEN. PLEASE CHECK THE ACTION OF THE FPC TO BE USED REPEATEDLY AT THE TIME OF TRIAL PRODUCTION. BE CAREFUL TO UN-MATE THEM FROM THE PITCH DIRECTION, PULLING IT FROM THE CORNER CAN ALSO RISK TO PUTTING STRESS ON CONTACTS.

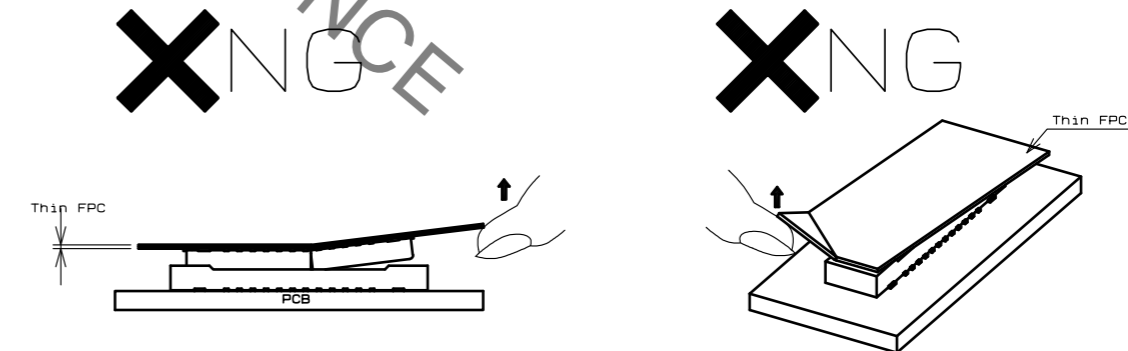

HRS	DRAWING NO.	EDC-399145-53-01
	PART NO.	BM28B0. 6-46DP/2-0. 35V<53>
	CODE NO.	CL0673-5097-0-53
		3/3

Oct.1.2022 Copyright 2022 HIROSE ELECTRIC CO., LTD. All Rights Reserved. In case of consideration for using Automotive equipment / device which demand high reliability, kindly contact our sales window correspondents.

HRS DRAWING FOR REFERENCE