

Jan.1.2025 Copyright 2025 HIROSE ELECTRIC CO., LTD. All Rights Reserved.
 本製品を車載用途などの高い信頼性が求められる機器にご使用の場合は、弊社までお問合せ下さい。

ELV. RoHS適合品

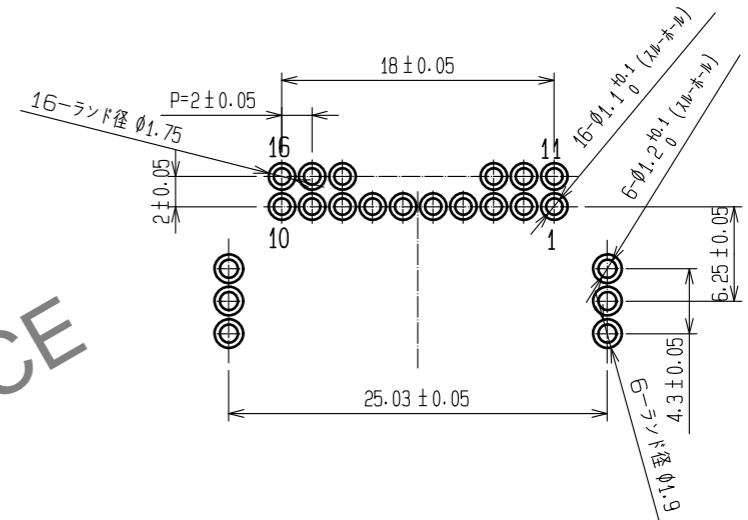
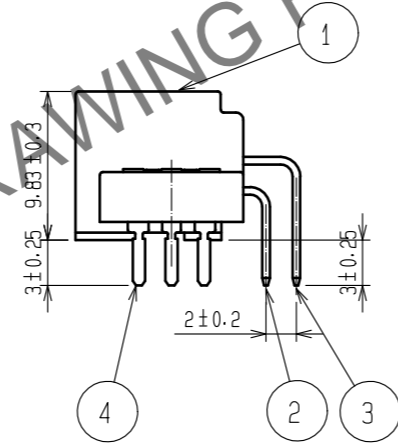
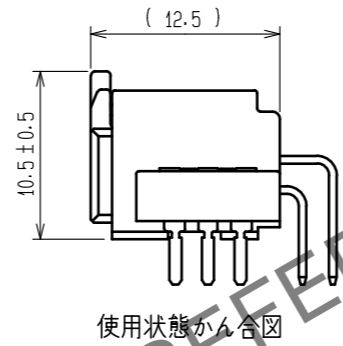
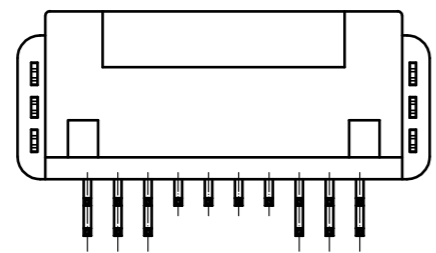
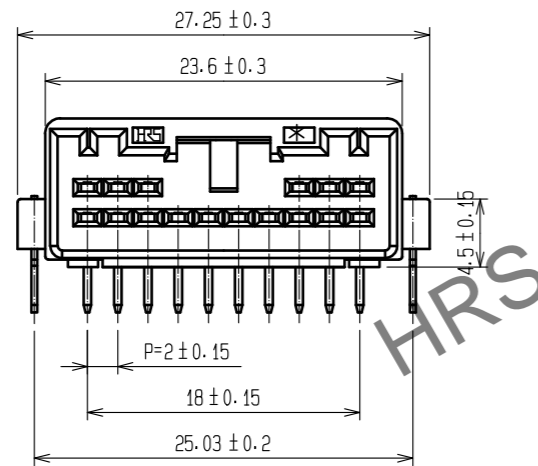
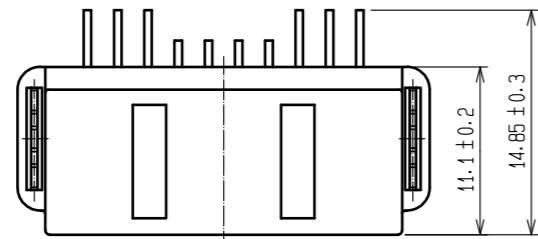
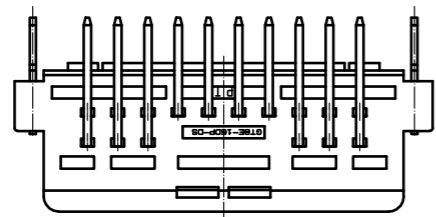

推奨基板パターン図 (コネクタ側及びピン番号)

2	BRASS	TIN PLATING	4	BRASS	TIN PLATING
1	PBT	BLACK	3	BRASS	TIN PLATING
NO.	MATERIAL	FINISH . REMARKS	NO.	MATERIAL	FINISH . REMARKS
UNITS mm		SCALE 2 : 1	COUNT 	DESCRIPTION OF REVISIONS	DESIGNED
HIROSE ELECTRIC CO., LTD.			APPROVED : HH. TSUKUMO	20200321	DRAWING NO.
			CHECKED : HH. TSUKUMO	20200321	PART NO.
			DESIGNED : DONGCHAN KIM	20200320	CODE NO.
			DRAWN : YK. MITSUISHI	20200310	
				20200321	ADC-166761-55-00
				20200321	GT8E-16DP-DS(55)
				20200320	
				20200310	CL758-0060-7-55
					1/1