

BF4M Series

Active Optical Connector

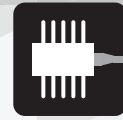

AOC



Low Power



Noise Prevention

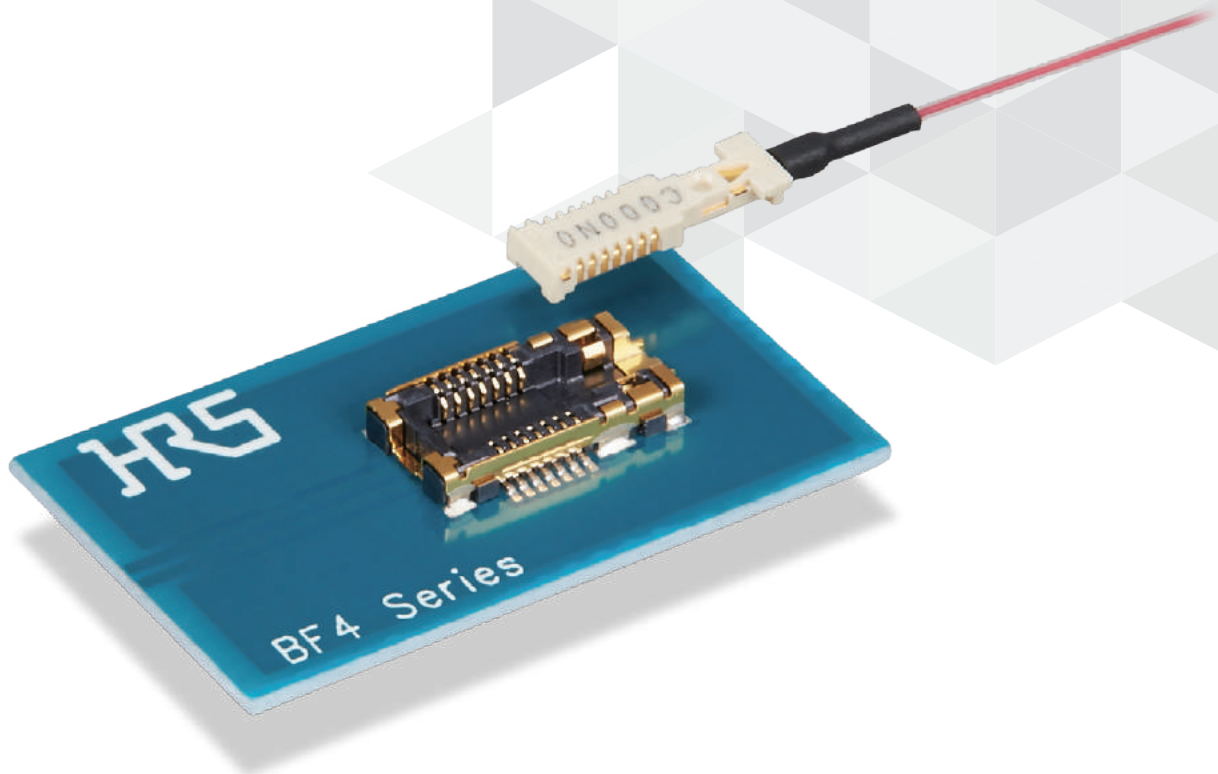

Overview

Hirose developed the micro "BF4MC connector" that enables optical transmission of data between boards that are incorporated in devices.

It converts an electrical signal that is received from a board by using the semiconductor component built in the connector and then transfers the data via optical fiber.

The BF4MC connector has a revolutionary design that enables easy use of the benefits of optical transmission, including electromagnetic noise-free, insulated, long-distance, high speed transmission. Mounting inside devices achieves dramatic space saving and lower power consumption when compared to existing optical products.

It can be used in a wide range of applications, including medical appliances, measurement equipment, FA systems, etc. Please consult with a Hirose representative when considering for applications that require high reliability such as automotive.

Features

1. Optical Transmissions Achieved by Simplified Electrical Connections

An easy transmission is accomplished with electronic connectors and eliminates the need for cleaning the mating faces of traditional fiber optic connectors.

2. High Speed Signal Transmissions with No EMI Noise.

Optical signal transmissions rated up to 6.25 Gbps are possible. Since there is no EMI noise on the signal lines, system design time will be saved.

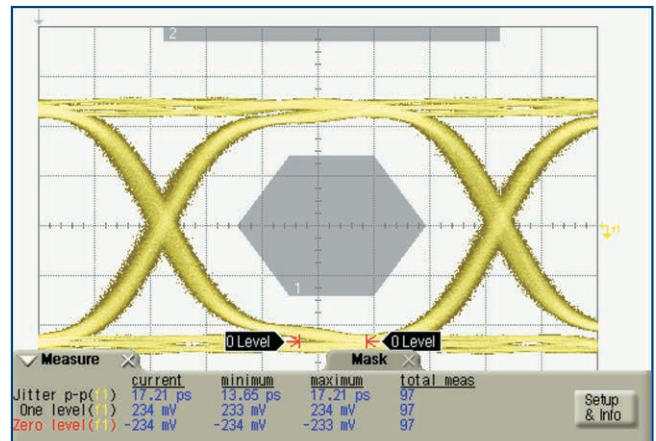

Eye Diagram (Typical) :
Transmission Speed 6.25 Gbps, Length 5 meters

3. Highly Flexible Optical Fiber

A highly flexible optical fiber is useful for narrow space wiring within devices.

4. Long Distance, High Speed and High Quality Signal Transmissions

The BF4M design is capable of high speed and high quality signal transmissions even over long transmission distances.

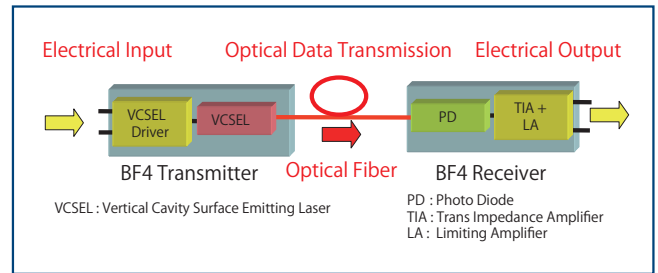

Block Diagram

5. Low Power Consumption

Power consumption is significantly reduced compared to a conventional optical transceiver.

6. Space-Saving and Low Profile Design with 1.5mm Height

Using the BF4M enables optical transmission with the same small form factor as electronic connectors.

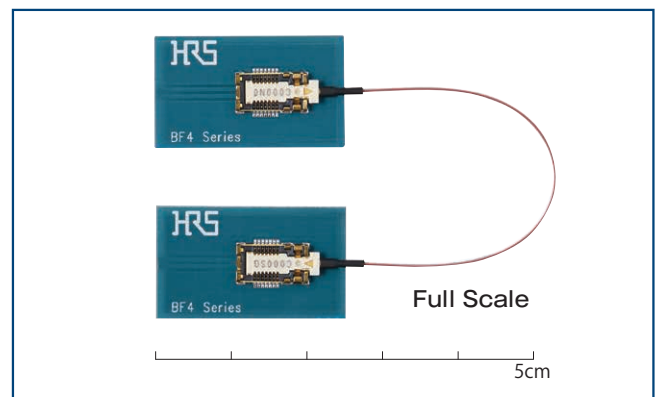

7. Hirose offers a wide array of optical in-line and device to device connection types.

Electrical Characteristics

● Electrical Characteristics of BF4MC-TX (Transmitter Side)

	Min.	Nominal	Max.	Unit
Transmission Speed (8B/10B)	0.05	-	6.25	Gbps
VDD Voltage	2.25	2.5/3.3	3.6	V
ACTIVATE = H Voltage	1.0	-	VDD Voltage	V
DIN Common Voltage	150	-	340	mVp
DIN Differential Voltage	200	-	1400	mVp

● Electrical Characteristics of BF4MC-RX (Receiver Side)

	Min.	Nominal	Max.	Unit	Remarks
Transmission Speed (8B/10B)	0.05	-	6.25	Gbps	-
VDD Voltage	2.25	2.5/3.3	3.6	V	-
VDD 15 Voltage	1.45	1.5	1.55	V	When driving with dual power sources
DOUT Common Voltage	160	-	330	mVp	-
DOUT Differential Voltage	160	-	330	mVp	-
SD = H Voltage	1.0	1.5	1.6	V	-

<Pin Assignment>

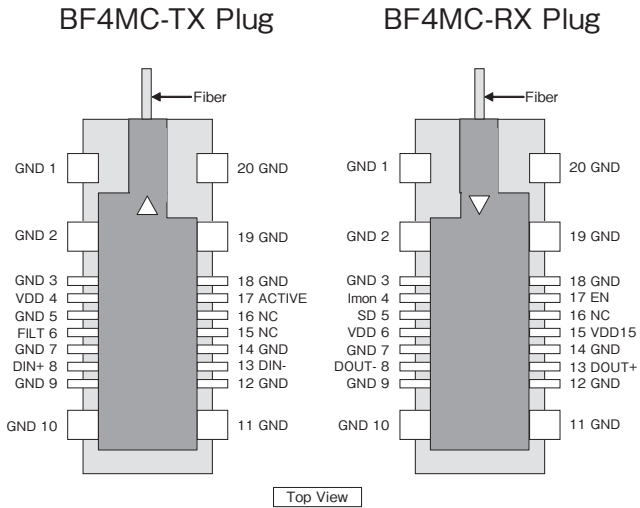

<Pin Functions>

Descriptions of BF4MC-TX Pins

Symbol	Name	Type	Details
VDD	Vsupply	Power	Power Supply DC+2.5 or +3.3V
GND	Ground	Ground	-
ACTIVE	Activate	Input	H Voltage : Active Mode L Voltage : Sleep Mode
FILT	Filter	-	Decoupling Capacitor Connection Contact
DIN+	Data input +	Input	Differential Data Input
DIN-	Data input -	Input	Differential Data Input
NC	Not Connect	-	Not Connected in Normal Operation

Descriptions of BF4MC-RX Pins

Symbol	Name	Type	Details
VDD	Vsupply	Power	Power for PD(*)
VDD15	Vdd1.5V	Power	Power for Core(*)
GND	Ground	Ground	-
SD	Signal Detect	Output	H Voltage : Detected L Voltage : Undetected
DOUT+	Data Output +	Output	Differential Data Output
DOUT-	Data Output -	Output	Differential Data Output
EN	Regulator Enable	Input	[Dual Supply Mode] Not Connected [Single Supply Mode] EN Pin Must be Connect to VDD
Imon	Mirrored Photodiode Current Monitor	Output	Not Connected (Inspection Pin)
NC	Not Connect	-	Not Connected in Normal Operation

Note : For details, see the BF4MC Design Note ETAD-K0671.

Product Materials

● Plug Harnesses

Component		Details
Transmitter Plug (TX)	Housing	LCP (BF4MC : White)
	Contact	Phosphor Bronze (Gold Plating)
	Plate	Phosphor Bronze (Nickel Plating)
	VCSEL	GaAs
	VCSEL Driver	Si (CMOS)
	Bonding Wire	Gold
	Sealing Resin	Epoxy Resin
	Heat Shrink Tubing	Polyolefin (Black)
	ESD Cap	TPC (Black)
Receiver Plug (RX)	Housing	LCP (BF4MC : White)
	Contact	Phosphor Bronze (Gold Plating)
	Plate	Phosphor Bronze (Nickel Plating)
	PD	GaAs
	TIA/LA	Si (CMOS)
	Bonding Wire	Gold
	Sealing Resin	Epoxy Resin
	Heat Shrink Tubing	Polyolefin (Black)
	ESD Cap	TPC (Black)
Optical Fiber	Fiber	Silica Glass (GI50/80)
	Coating	UV Curable Resin/Thermo Plastic Resin(ϕ 0.5)
SC Connector	Housing	PBT (Blue)
	Boot	TPC (Blue)
	Spring	Stainless Steel
	Ferrule	ZrO2
	Ferrule Flange	Stainless Steel
	Cap	TPC (Black)
LC Connector	Housing	PEI (Beige)
	Boot	Elastomer (White)
	Spring	Stainless Steel
	Ferrule	ZrO2
	Ferrule Flange	Brass
	Cap	TPC (Black)

● Receptacles

Component		Materials
Transmitter Receptacle (TX) and Receiver Receptacle (RX)	Housing	LCP (Black)
	Contact	Phosphor Bronze (Gold Plating)
	Shell	Phosphor Bronze (Gold Plating)

Product Number Structure

Refer to the chart below when determining the product specifications from the product number.
Please select from the product numbers listed in this catalog when placing orders.

Plug Harness

BF4M C-6G TX RX - B1 - 75MM

① ② ③ ④ ⑤ ⑥

① Series	BF4M	⑤ Type of Fiber Cable	B1 : Diameter ϕ 0.5, Red B2 : Diameter ϕ 0.5, Blue
② Bit Rate	C-6G : 0.05 to 6.25 Gbps	⑥ Fiber Cable Length	*Cable length 1m Max. \Rightarrow The end of the product name·##MM (Millimeter) *Cable length 1m Min. \Rightarrow The end of the product name·##M (Meter)
③ ④ Type of plug that attaches to both ends of the harness	TX : BF4 Transmitter Plug SC : SC Connector RX : BF4 Receiver Plug LC : LC Connector		

Receptacle

BF4 - TX - 14 DS - 0.5 V (##)

① ② ③ ④ ⑤ ⑥ ⑦

① Series	BF4	⑥ Mating Method	V : Vertical Mated to the Mounting Surface
② Transmitter/ Receiver	TX : Transmitter RX : Receiver	⑦ Packing Specifications	None : 500pcs per reel (01) : 1000pcs per reel (02) : 2000pcs per reel (10) : 10pcs per bag (11) : 100pcs per reel
③ No. of Pos.	14		
④ Socket Shape	Socket (S) of Double line assignment pins (D)		
⑤ Pitch	0.5mm		

BF4 Variations

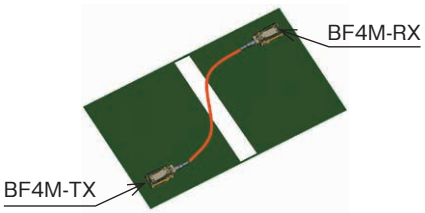
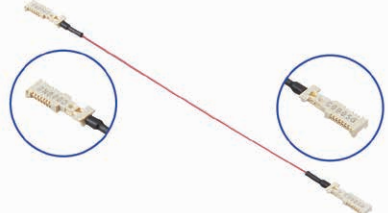
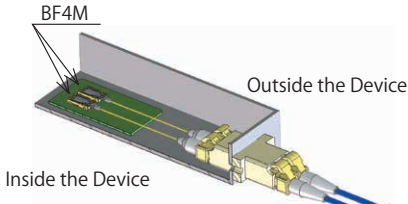
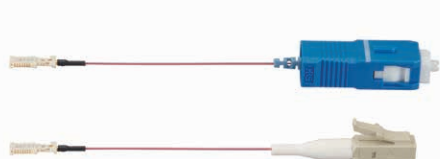
Type	Usage Image	Product Image
Both Ends BF4M (Connection for board-to-board)		
One End BF4M, the Other Conventional Optical Connector (SC,LC) In-line Optical Connector (In-line Connection Between Inside and Outside the Device)		

Connection Example of +3.3V (Single Power Supply Mode)

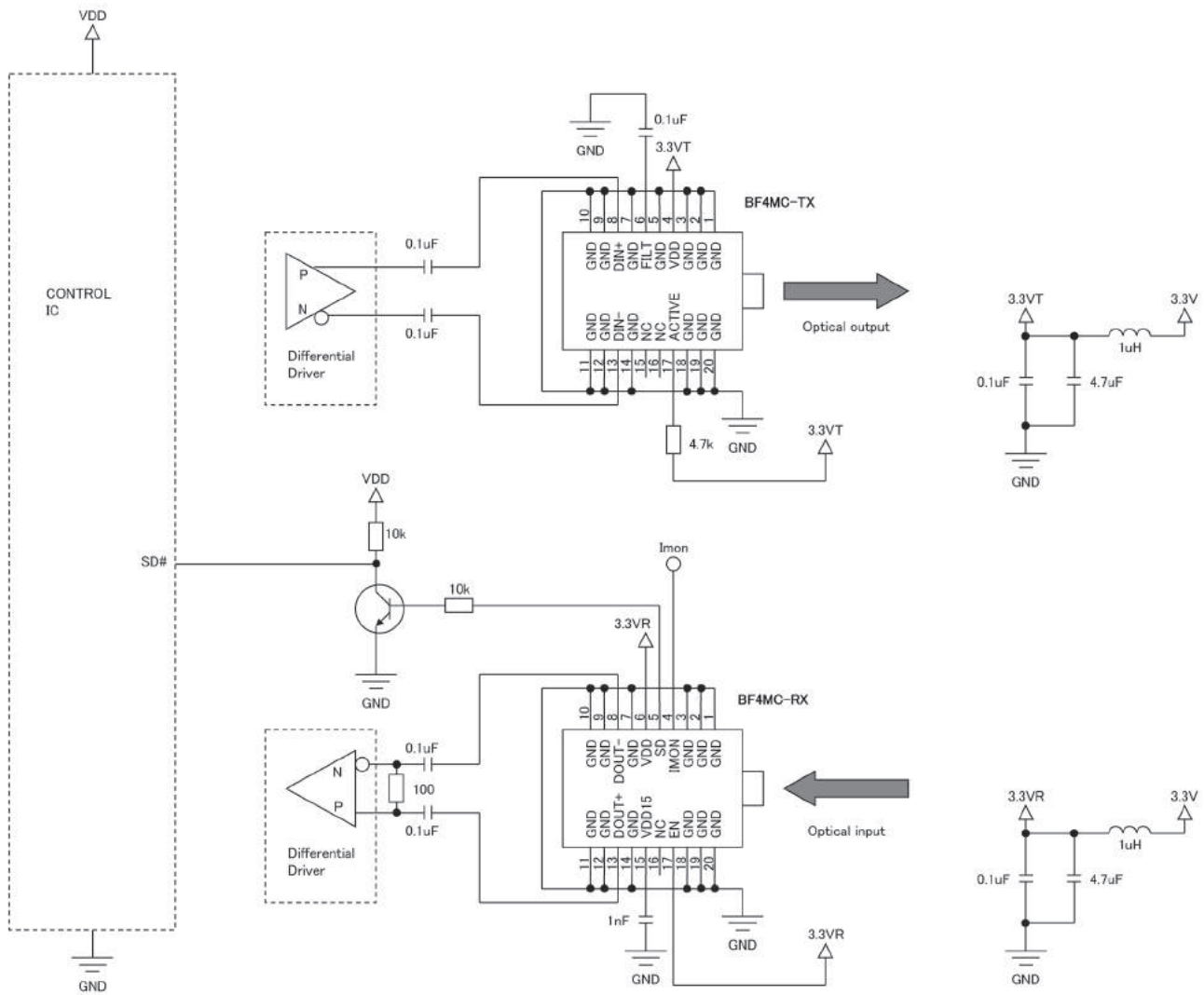

Plug Harness

● BF4MC Harness

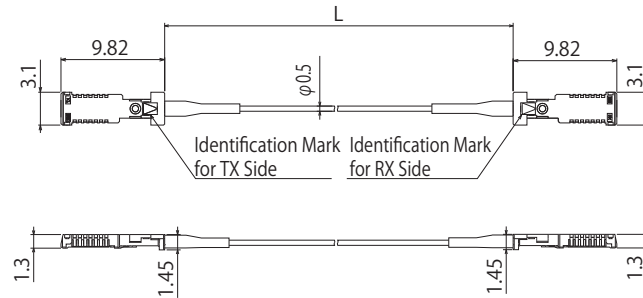
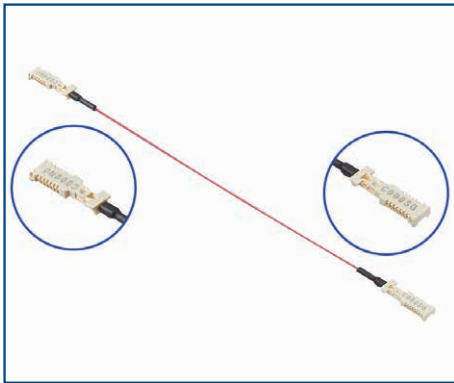

● BF4MC Harness (Representative Product)

Part No.	HRS No.	Fiber	Cable length L	Purchase Unit
BF4MC-6GTXRX-B1-45MM	CL0831-1102-0-04	φ 0.5 Red	45mm	15pcs per tray
BF4MC-6GTXRX-B1-50MM	CL0831-1102-0-05		50mm	
BF4MC-6GTXRX-B1-55MM	CL0831-1102-0-06		55mm	
BF4MC-6GTXRX-B1-60MM	CL0831-1102-0-07		60mm	
BF4MC-6GTXRX-B1-65MM	CL0831-1102-0-08		65mm	
BF4MC-6GTXRX-B1-70MM	CL0831-1102-0-09		70mm	
BF4MC-6GTXRX-B1-75MM	CL0831-1102-0-00		75mm	
BF4MC-6GTXRX-B1-80MM	CL0831-1102-0-11		80mm	
BF4MC-6GTXRX-B1-85MM	CL0831-1102-0-12		85mm	
BF4MC-6GTXRX-B1-90MM	CL0831-1102-0-13		90mm	
BF4MC-6GTXRX-B1-95MM	CL0831-1102-0-14		95mm	
BF4MC-6GTXRX-B1-100MM	CL0831-1102-0-15		100mm	
BF4MC-6GTXRX-B1-1M	CL0831-1109-9-00		1m	
BF4MC-6GTXRX-B1-2M	CL0831-1109-9-01	2m		
BF4MC-6GTXRX-B1-3M	CL0831-1109-9-02	3m		
BF4MC-6GTXRX-B1-4M	CL0831-1109-9-03	4m		
BF4MC-6GTXRX-B1-5M	CL0831-1109-9-04	5m		

Note 1 : The shortest harness length is 45mm, and harnesses up to 100mm in length are available in 5mm increments. (45mm, 50mm, 55mm...100mm)

Note 2 : Harness lengths other than those listed above are also available upon request. Please inform a Hirose representative of your desired harness length.

Note 3 : Blue fiber color is also available. Contact a Hirose sales representative for details.

● BF4MC - SC Connector Harness

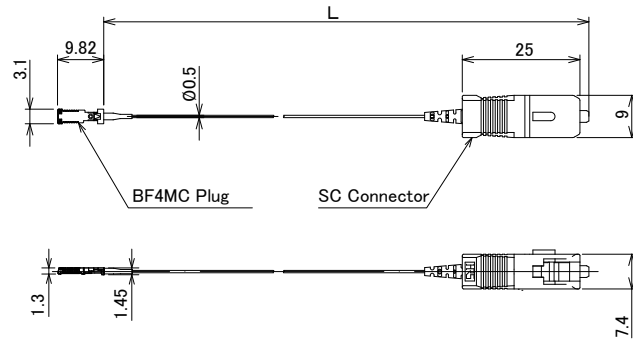

● BF4MC - SC Connector Harness (Representative Product)

Part No.	HRS No.	Fiber	Length	TX or RX
BF4MC-6GTXSC-B1-100MM	CL0831-1111-0-00	φ 0.5 Red	100mm	TX
BF4MC-6GRXSC-B1-100MM	CL0831-1112-0-00		100mm	RX
BF4MC-6GTXSC-B1-500MM	CL0831-1111-0-05		500mm	TX
BF4MC-6GRXSC-B1-500MM	CL0831-1112-0-05		500mm	RX

Note 1 : The shortest harness length is 100mm.

Note 2 : Please use the BF4MC transmitter and receiver connectors together.

Note 3 : Harness lengths other than those listed above are also available upon request. Please inform a Hirose representative of your desired harness length.

Note 4 : Blue fiber color is also available.

● BF4MC - LC Connector Harness

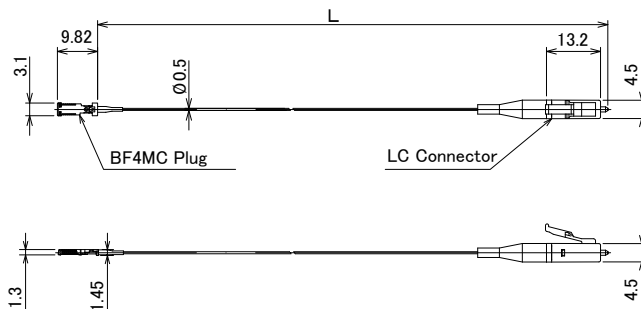

● BF4MC - LC Connector Harness (Representative Product)

Part No.	HRS No.	Fiber	Length	TX or RX
BF4MC-6GTXLC-B1-100MM	CL0831-1114-0-00	φ 0.5 Red	100mm	TX
BF4MC-6GRXLC-B1-100MM	CL0831-1135-0-00		100mm	RX
BF4MC-6GTXLC-B1-500MM	CL0831-1114-0-05		500mm	TX
BF4MC-6GRXLC-B1-500MM	CL0831-1135-0-05		500mm	RX

Note 1 : The shortest harness length is 100mm.

Note 2 : Please use the BF4MC transmitter and receiver connectors together.

Note 3 : Harness lengths other than those listed above are also available upon request. Please inform a Hirose representative of your desired harness length.

Note 4 : Blue fiber color is also available.

Receptacle

● Receptacle : Transmitter (TX)

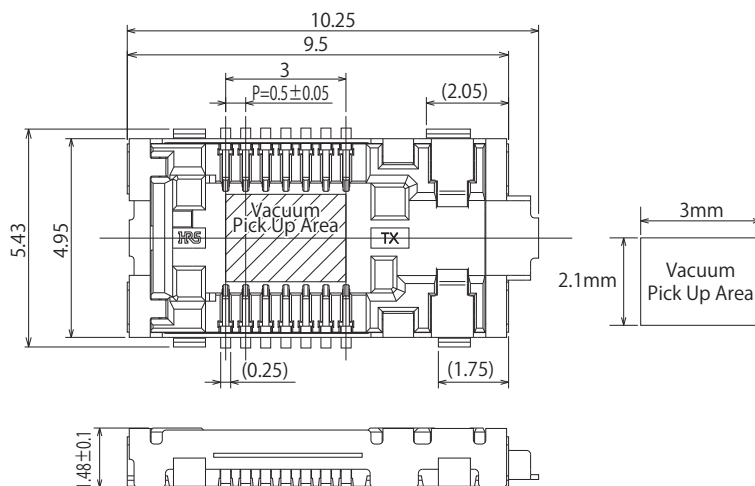
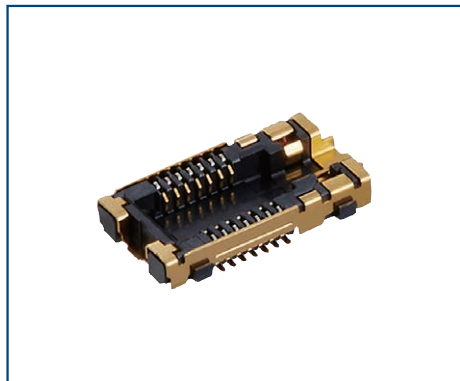

Note : Designed so that the receiver (RX) plug does not mate.

Part No.	HRS No.	Purchase Unit
BF4-TX-14DS-0.5V	CL0831-0008-6-00	500pcs per reel
BF4-TX-14DS-0.5V(01)	CL0831-0008-6-01	1000pcs per reel
BF4-TX-14DS-0.5V(02)	CL0831-0008-6-02	2000pcs per reel
BF4-TX-14DS-0.5V(10)	CL0831-0008-6-10	10pcs per bag
BF4-TX-14DS-0.5V(11)	CL0831-0008-6-11	100pcs per reel

● Receptacle : Receiver (RX)

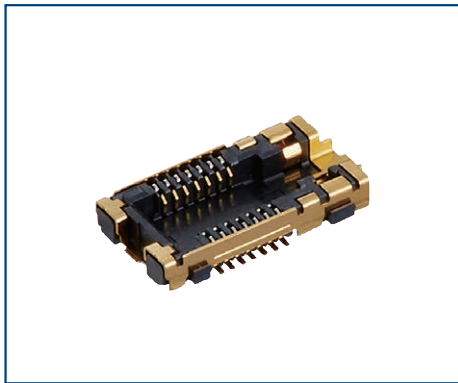

Note : Designed so that the transmitter (TX) plug does not mate.

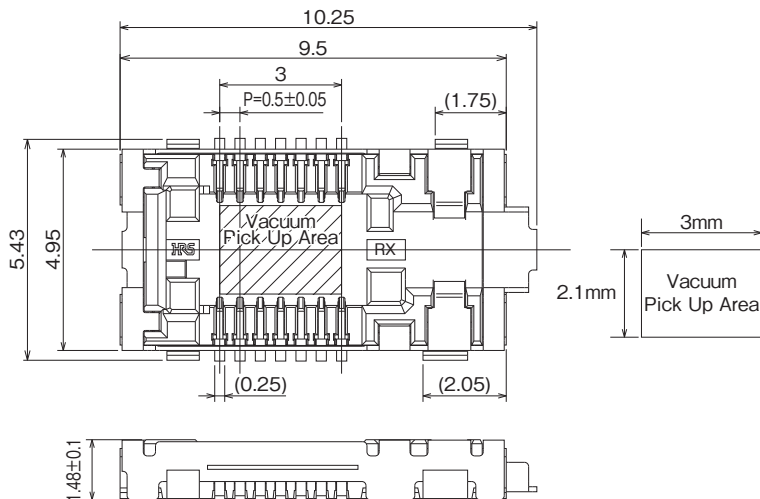

Part No.	HRS No.	Purchase Unit
BF4-RX-14DS-0.5V	CL0831-0009-9-00	500pcs per reel
BF4-RX-14DS-0.5V(01)	CL0831-0009-9-01	1000pcs per reel
BF4-RX-14DS-0.5V(02)	CL0831-0009-9-02	2000pcs per reel
BF4-RX-14DS-0.5V(10)	CL0831-0009-9-10	10pcs per bag
BF4-RX-14DS-0.5V(11)	CL0831-0009-9-11	100pcs per reel

● Pattern Layout

Recommended PCB Land Pattern Dimensions

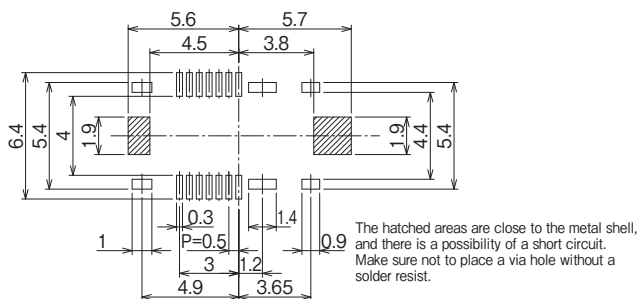

Recommended Stencil Dimensions
(Stencil Thickness 120μm)

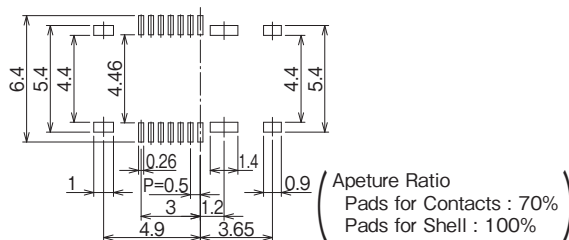

● Packaging Specifications

Reel Dimensions

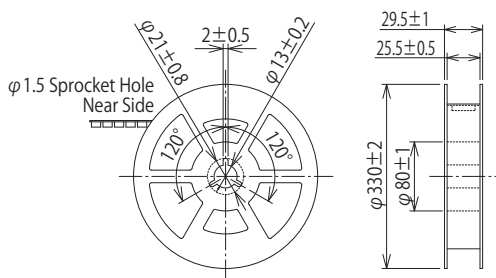

Emboss Carrier Tape Dimensions

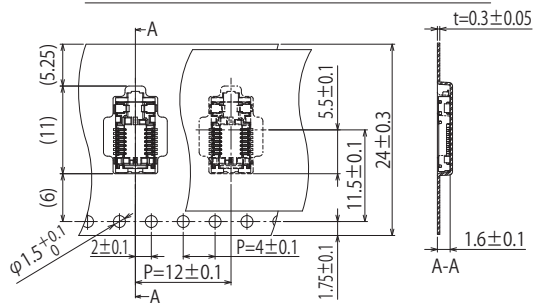

Extraction Tool

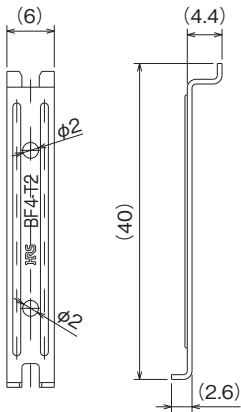

Part No.	HRS No.	Purchase Unit
BF4-T2	CL0831-0006-0-00	1 pcs per bag

Recommended Reflow Temperature Profile (Lead-Free Solder)

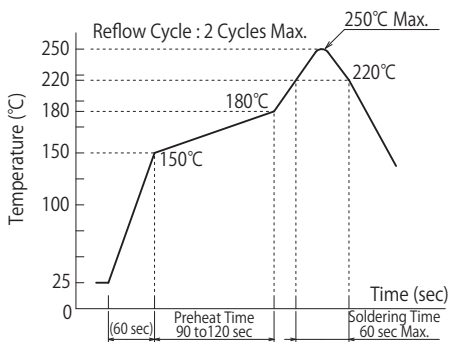

Test Board

PCBs for testing and evaluation are available.
Please contact us for more information.

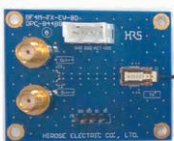

BF4M High Speed
Transmission Board : TX2



BF4M High Speed
Transmission Board : RX2

Connector Mating Method

Do not mate the connector while power is being supplied.

Make sure to insert or remove the plug after the power supply is turned off. Hot plugging/unplugging may cause damage.

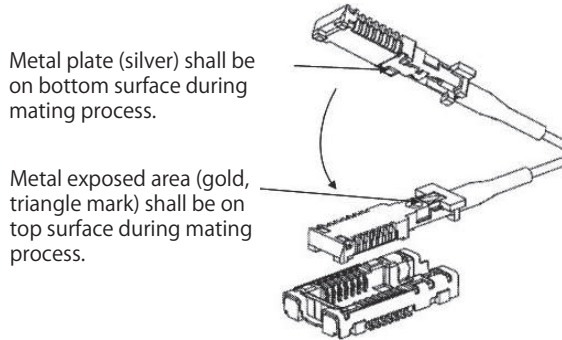

Cautions for Connector Unmating

Do not pull the fiber when removing the connector.

When removing the connector, make sure to hook the plug with an extraction tool so that the stress is not applied to the cable. Pulling the cable to remove it may cause a breakage in the cable. Please unmate by hooking onto the plug that protrudes slightly from the optical fiber for easy unmating.



Do not remove the plug while power is being supplied.

Make sure to remove the plug after the power supply is stopped. Hot plugging / unplugging may cause damage.

Precautions for Optical Connectors

Refer to the optical fiber catalog for cautions on handling cables with optical connectors.

Precautions

Connector Operation and Precautions

(Notes on change of information)

- The content of this document including the information regarding the connector (hereafter, the Product) is subject to change without prior notice.

(Prohibition of reproduction)

- No part of this document may be copied or reproduced without prior written consent of Hirose Electric Co., Ltd. (hereafter, Hirose). Even if written consent of Hirose is obtained, it is prohibited to amend any part of this document and copy or reproduce it. Hirose shall assume no obligation or liability in connection with such amended information or reproduction.

(Responsibilities for design safety)

- Hirose shall assume no responsibilities for the support for the application of the Product or the product design of the customer. The customer shall be responsible for the product and application of the customer in which the Product is used. The customer shall take appropriate design and operational safety measures in order to minimize the potential risks predicted for the product and application of the customer in which the Product is used.

(Responsibilities for determination of the suitability)

- When using the Product, the customer shall ensure safe design at his/her own responsibility so that malfunction or failure of the Product would never cause an infringement on life, body or property. For design or use of the Product, make sure to refer to the materials (including the catalog, specifications, and design note) and follow the same. When using information including the product data provided in the document, technical data or circuit examples shown in the figures and tables, the customer shall evaluate the information on the customer's product and determine the suitability at the customer's own responsibility.

(Responsibilities for specific applications)

- Make sure to consult with our sales representative in advance when considering of use for specific applications that require extremely high quality and reliability (e.g. nuclear equipment, aerospace systems, transportation equipment and various safety related equipment).

(Prohibition of replication)

- Do not disassemble, reverse-engineer, modify, analyze or replicate the Product.

(Prohibition of application to prohibited products)

- The Product must not be used for any product in which the manufacturing, use or sale of which is prohibited by domestic or international laws, regulations and ordinances.

(Notes on the guarantee and license)

- The technical data provided in the materials of the Product is intended to describe the representative behaviors and application of the Product. It is not to guarantee the intellectual property rights or any other rights of Hirose nor a third party and not to grant the license.

(Notes on the warranties for the contract)

- Unless otherwise provided in a written contract or other documents (specifications) agreed between the customer and Hirose, Hirose makes no warranties of any kind (including, but not limited to, warranties of the function and operation, warranties of merchantability, warranties of suitability for a specific application or purpose and warranties of correctness of the information).

(Notes on export)

- To export the Product to other countries, the exporter shall conduct the applicability determination based on Foreign Exchange and Foreign Trade Act of Japan. If you wish to have the applicability determination sheet issued by Hirose, contact our sales representative. Note that in the export arrangement, the customer shall be an exporter and responsible for compliance with all the applicable laws and regulations and terms and conditions of the agreement with Hirose.

Connector Operation and Precautions

(Notes on the specification range)

- Using the Product under conditions beyond the specification range (for voltage, current and temperature) provided in this document may result in an accident (including ignition, heat generation, and smoking). Confirm the document thoroughly and make sure to use the Product within the specification range.

(Notes on the laser)

- The laser beam is emitted from the end-face of the optical fiber in operation. It may cause eye injury or loss of sight if it enters the eyes. Do not stare directly into the end-face of the optical fiber. The laser beam is emitted from the VCSEL in operation. It may not be visible depending on its wavelength, but nonetheless it may cause eye injury or loss of sight if the laser beam or its reflected beam enters the eyes. Do not stare (look into) the laser beam directly.

(Notes on fracture of the optical fiber)

- In case of fracture of the optical fiber used in the Product, turn off the power immediately. In addition, use care when handling it to avoid injury from fractured parts or fragments.

(Notes on use of GaAs)

- The Product is equipped with a semiconductor within the connector and contains gallium arsenide (GaAs).

(Notes on the environment including gases)

- Avoid the use of the Product in gas environments with chlorides or sulfides. The Product may deteriorate and features may be affected.

(Notes on storage)

- Store the Product out of corrosive substances, corrosive gases, high temperature and humidity or direct sunlight. Do not apply excessive pressure or vibration to the Product. It may cause deterioration, deformation, damage or failure of the Product.

(Notes on resin molded part)

- The resin molded part of the Product may contain black spots or its color may be slightly different, but that has no effect on the product performance.

While Taking into Consideration

Specifications mentioned in this catalogue are reference values.

While considering to order or to use this product, please confirm the "Drawing" and "Product Specifications" sheets.

While using connector with cable combination, please use appropriate cable.

If considering usage of inappropriate cable, please contact our sales representative.

If assembly process is done using jigs & tools which are not identified by our company, in such cases assurance will not be given.

If considering usage for below mentioned applications, please contact our sales representative.

As per condition, it needs to be considered whether assurance can be given or not.

In cases where the application will demand a high level of reliability, such as automotive, Medical instruments, Public infrastructure, aerospace/ defense etc.