

0.5/1.0mm Pitch, 1.75/2.0mm Height, Bottom Contact, Front Flip FPC/FFC Connector

TF31 Series

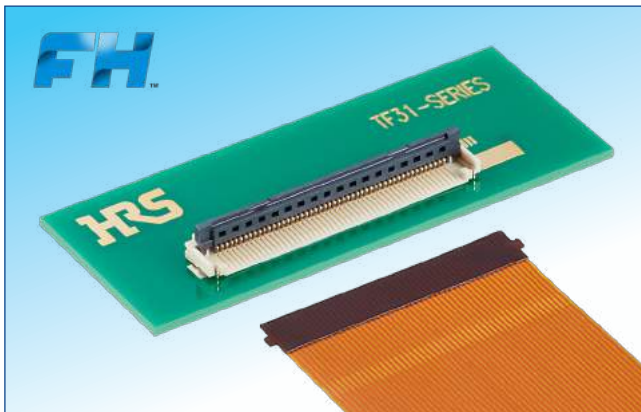

FH Flip-Lock Pioneer Hirose

■ Features

1. Multiple height and pitch variations available

This series offers two different contact pitches of 0.5 and 1.0mm and two heights variations of 1.75 and 2.0mm. These options give engineers the ability to choose the connector that will best fit their design. (Figure. 1)

2. FPC/FFC side catcher design

The TF31 Series incorporates Hirose's FPC/FFC side catcher technology. This design feature enables the tabbed FPC/FFC to be placed in the correct position while achieving stability and excellent FPC/FFC retention force. (Figure. 2)

3. Easy FPC/FFC insertion

The actuator is designed to open widely, to approximately 110°, providing excellent FPC/FFC insertion operability.

4. Rugged design

Each terminal is attached to the actuator, which provides support to the actuator across its entire length. This prevents the actuator from separating from the housing.

5. Prevents unintended actuator opening

The TF31 Series has an interference design that prevents the actuator from unintentionally opening.

6. Maximizes board space

The bottom surface of the connector is over-molded. This allows the PCB space under the connector to be utilized for additional PCB routing.

7. Pick & Place mounting

Offered in tape and reel packaging that is compatible with automatic machine mounting.

8. Multiple packaging options

The standard packaging is 3,000pcs/reel, but TF31 Series is also available in 500pcs/reel. (The outer diameter of the reel is ϕ 180mm for non-standard packaging.)

9. Halogen-Free

All materials and substances used to produce this product comply with Halogen-free standards.

*As defined by IEC 61249-2-21.

Br : 900ppm max., Cl : 900ppm max., Br+Cl : 1,500ppm max.

Multiple Height and Pitch Variations Available

Pitch variations

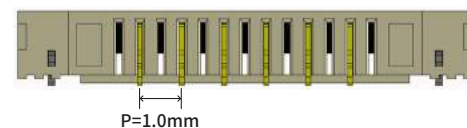
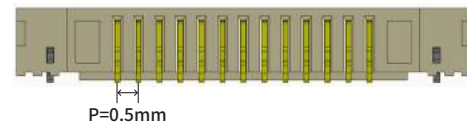

Height variations

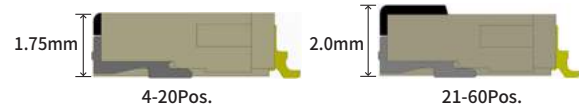

Alternating Direction

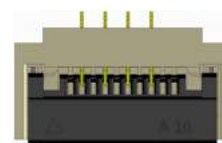

EX) TF31-10(4)SA-1SH(800)
(Alternating on the polarity side)

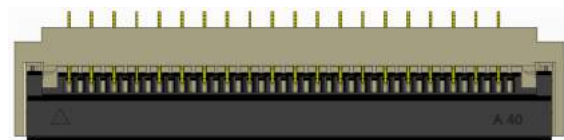

EX) TF31-40(20)SB-1SH(800)
(Alternating on the opposite polarity side)

Figure.1

FPC/FFC Positioning Alignment

FPC/FFC Positioning Mechanism

Standard FPC/FFC

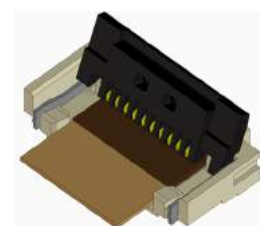
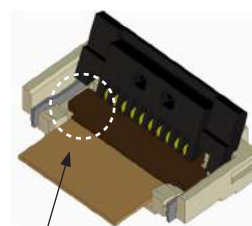

FPC/FFC tabs for greater retention force in the horizontal direction

Figure.2

Product Specifications

Ratings	Rated Current : 0.5A (Note1)	Operating Temperature : -40 to +105°C (Note2) Operating Humidity Range : Relative humidity : 90% Max. (No condensation)	Storage Temperature : -10 to +50°C (Note3) Storage Humidity Range : Relative humidity : 90% Max. (No condensation)
	Rated Voltage : 50V AC rms		

Adaptive FPC/FFC contact specifications	Thickness : 0.3±0.03mm Gold plated contact traces
---	---

Items	Specifications	Conditions
1. Insulation Resistance	500MΩ Min.	100V DC
2. Withstanding Voltage	No flashover or insulation breakdown	150V AC rms for 1 min.
3. Contact Resistance	50mΩ Max. *Including FPC/FFC conductor resistance	1mA
4. Durability (Insertion/withdrawal)	Contact resistance : 50mΩ Max. No damage, cracks, or parts dislocation.	20 cycles
5. Vibration	No electrical discontinuity of 1μs or more. Contact resistance : 50mΩ Max. No damage, cracks, or parts dislocation	Frequency : 10 to 55Hz, total amplitude of 1.5mm for 2hours in 3 axis directions
6. Shock	No electrical discontinuity of 1μs or more Contact resistance : 50mΩ Max. No damage, cracks, or parts dislocation.	Acceleration : 981m/s ² , 6ms duration, Sine half-waveform, 3 cycles in each of the 3 axis.
7. Humidity (Steady state)	Contact resistance : 50mΩ Max. Insulation resistance : 50MΩ Min. No damage, cracks, or parts dislocation	96 hours at a temperature of 40°C and humidity of 90% to 95%
8. Temperature Cycle	Contact resistance : 50mΩ Max. Insulation resistance : 50MΩ Min. No damage, cracks, or parts dislocation	Temperature : -40 → +15 to +35 → +105 → +15 to +35°C Time : 30 → 2 to 3 → 30 → 2 to 3 (min.) 5 cycles
9. Resistance to Soldering Heat	No deformation of components affecting performance	Reflow : At the recommended temperature profile Manual soldering : 350±10°C for 5 seconds

Note 1 : When passing the current through all of the contacts, use 70% of the current rating.

Note 2 : Includes temperature rise caused by current flow.

Note 3 : The term “storage” refers to products stored for long period of time prior to mounting and use.

Operating temperature and humidity range covers non-conducting condition of installed connectors in storage, shipment or during transportation.

Material / Finish

Part	Material	Finish	Remarks
Insulator	LCP	Beige	UL94V-0
Actuator	LCP	Black	
Contact	Phosphor bronze	Partially Gold plated	
Retention Tab	Brass	Tin plated	-----

Product Number Structure

Refer to the chart below when determining the product specifications from the product number.

Please select from the product numbers listed in this catalog when placing orders.

TF **31** - **##** **(##)** **S** **A** - **0.5** **SH** **(###)**
① ② ③ ④ ⑤ ⑥ ⑦ ⑧ ⑨

① Series Name : TF	⑥ Alternating direction : Please refer to Figure 1 on Page 1 No symbol : Standard type(all contacts loaded) A : Alternating contact type(Alternating on the polarity side) B : Alternating contact type(Alternating on the opposite polarity side)
② Series No. : 31	⑦ Contact Pitch : 0.5mm, 1mm
③ Standard Type : Number of contacts Alternating Contact Type : Mold size	⑧ Terminal Type SH : SMT horizontal mounting type
④ Standard Type : No symbol Alternating Contact Type : Number of contacts	⑨ Specification (800) : Partially Gold plated, Emboss tape packaging (3,000pcs/reel) (895) : Partially Gold plated, Emboss tape packaging (500pcs/reel)
⑤ Contact arrangement : Single(pole piece array)	

Connector Dimensions (0.5mm Pitch Product)

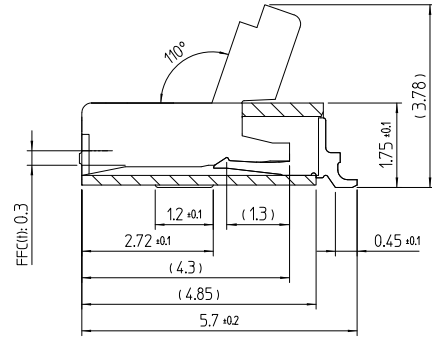
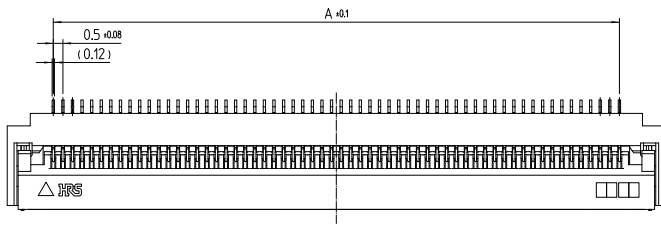

4-20Pos.

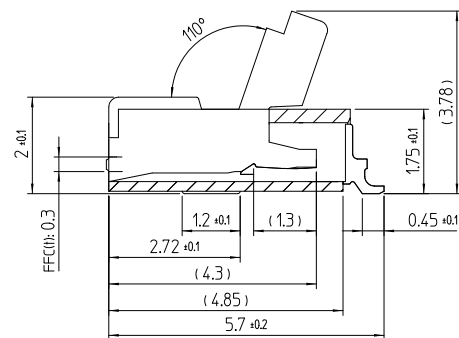
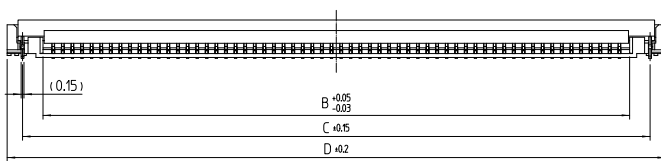

21-60Pos.

Note 1 : The coplanarity of each terminal lead is within 0.1mm.

Note 2 : This product is packaged and sold in tape and reel. Check the packaging specifications for details.

Note 3 : Sink mark reliefs may be added due to improvements.

Note 4 : Black spots may appear on the mold resin, but this does not affect product performance.

Additionally, the terminal plating may change color after reflow, however this does not represent a quality issue.

Unit : mm

Part No.	HRS No.	No. of contacts	A	B	C	D	Purchase Unit
TF31-4S-0.5SH(800)	480-0235-5 00	4	1.50	2.57	4.70	6.30	3,000pcs/Reel
TF31-6S-0.5SH(800)	480-0154-5 00	6	2.50	3.57	5.70	7.30	
TF31-7S-0.5SH(800)	480-0516-0 00	7	3.00	4.07	6.20	7.80	
TF31-8S-0.5SH(800)	480-0184-6 00	8	3.50	4.57	6.70	8.30	
TF31-10S-0.5SH(800)	480-0130-7 00	10	4.50	5.57	7.70	9.30	
TF31-12S-0.5SH(800)	480-0131-0 00	12	5.50	6.57	8.70	10.30	
TF31-13S-0.5SH(800)	480-0177-0 00	13	6.00	7.07	9.20	10.80	
TF31-14S-0.5SH(800)	480-0155-8 00	14	6.50	7.57	9.70	11.30	
TF31-16S-0.5SH(800)	480-0178-3 00	16	7.50	8.57	10.70	12.30	
TF31-17S-0.5SH(800)	480-0185-9 00	17	8.00	9.07	11.20	12.80	
TF31-18S-0.5SH(800)	480-0161-0 00	18	8.50	9.57	11.70	13.30	
TF31-20S-0.5SH(800)	480-0132-2 00	20	9.50	10.57	12.70	14.30	
TF31-21S-0.5SH(800)	480-0186-1 00	21	10.00	11.07	13.20	14.80	
TF31-22S-0.5SH(800)	480-0143-9 00	22	10.50	11.57	13.70	15.30	
TF31-24S-0.5SH(800)	480-0251-0 00	24	11.50	12.57	14.70	16.30	
TF31-25S-0.5SH(800)	480-0358-0 00	25	12.00	13.07	15.20	16.80	
TF31-26S-0.5SH(800)	480-0162-3 00	26	12.50	13.57	15.70	17.30	
TF31-28S-0.5SH(800)	480-0156-0 00	28	13.50	14.57	16.70	18.30	
TF31-30S-0.5SH(800)	480-0179-6 00	30	14.50	15.57	17.70	19.30	
TF31-32S-0.5SH(800)	480-0157-3 00	32	15.50	16.57	18.70	20.30	
TF31-35S-0.5SH(800)	480-0261-0 00	35	17.00	18.07	20.20	21.80	
TF31-36S-0.5SH(800)	480-0163-6 00	36	17.50	18.57	20.70	22.30	
TF31-40S-0.5SH(800)	480-0133-5 00	40	19.50	20.57	22.70	24.30	
TF31-45S-0.5SH(800)	480-0134-8 00	45	22.00	23.07	25.20	26.80	
TF31-50S-0.5SH(800)	480-0135-0 00	50	24.50	25.57	27.70	29.30	
TF31-53S-0.5SH(800)	480-0762-0 00	53	26.00	27.07	29.20	30.80	
TF31-54S-0.5SH(800)	480-0756-0 00	54	26.50	27.57	29.70	31.30	
TF31-55S-0.5SH(800)	480-0187-4 00	55	27.00	28.07	30.20	31.80	
TF31-60S-0.5SH(800)	480-0136-3 00	60	29.50	30.57	32.70	34.30	

Unit : mm

Part No.	HRS No.	No. of contacts	A	B	C	D	Purchase Unit
TF31-4S-0.5SH(895)	480-0235-0 95	4	1.50	2.57	4.70	6.30	500pcs/Reel
TF31-6S-0.5SH(895)	480-0154-0 95	6	2.50	3.57	5.70	7.30	
TF31-7S-0.5SH(895)	480-0516-0 95	7	3.00	4.07	6.20	7.80	
TF31-8S-0.5SH(895)	480-0184-0 95	8	3.50	4.57	6.70	8.30	
TF31-10S-0.5SH(895)	480-0130-0 95	10	4.50	5.57	7.70	9.30	
TF31-12S-0.5SH(895)	480-0131-0 95	12	5.50	6.57	8.70	10.30	
TF31-13S-0.5SH(895)	480-0177-0 95	13	6.00	7.07	9.20	10.80	
TF31-14S-0.5SH(895)	480-0155-8 95	14	6.50	7.57	9.70	11.30	
TF31-16S-0.5SH(895)	480-0178-3 95	16	7.50	8.57	10.70	12.30	
TF31-17S-0.5SH(895)	480-0185-9 95	17	8.00	9.07	11.20	12.80	
TF31-18S-0.5SH(895)	480-0161-0 95	18	8.50	9.57	11.70	13.30	
TF31-20S-0.5SH(895)	480-0132-0 95	20	9.50	10.57	12.70	14.30	
TF31-21S-0.5SH(895)	480-0186-0 95	21	10.00	11.07	13.20	14.80	
TF31-22S-0.5SH(895)	480-0143-0 95	22	10.50	11.57	13.70	15.30	
TF31-24S-0.5SH(895)	480-0251-0 95	24	11.50	12.57	14.70	16.30	
TF31-25S-0.5SH(895)	480-0358-0 95	25	12.00	13.07	15.20	16.80	
TF31-26S-0.5SH(895)	480-0162-0 95	26	12.50	13.57	15.70	17.30	
TF31-28S-0.5SH(895)	480-0156-0 95	28	13.50	14.57	16.70	18.30	
TF31-30S-0.5SH(895)	480-0179-0 95	30	14.50	15.57	17.70	19.30	
TF31-32S-0.5SH(895)	480-0157-0 95	32	15.50	16.57	18.70	20.30	
TF31-35S-0.5SH(895)	480-0261-0 95	35	17.00	18.07	20.20	21.80	
TF31-36S-0.5SH(895)	480-0163-0 95	36	17.50	18.57	20.70	22.30	
TF31-40S-0.5SH(895)	480-0133-0 95	40	19.50	20.57	22.70	24.30	
TF31-45S-0.5SH(895)	480-0134-0 95	45	22.00	23.07	25.20	26.80	
TF31-50S-0.5SH(895)	480-0135-0 95	50	24.50	25.57	27.70	29.30	
TF31-53S-0.5SH(895)	480-0762-0 95	53	26.00	27.07	29.20	30.80	
TF31-54S-0.5SH(895)	480-0756-0 95	54	26.50	27.57	29.70	31.30	
TF31-55S-0.5SH(895)	480-0187-0 95	55	27.00	28.07	30.20	31.80	
TF31-60S-0.5SH(895)	480-0136-0 95	60	29.50	30.57	32.70	34.30	

Connector Dimensions (1.0mm Pitch Product)

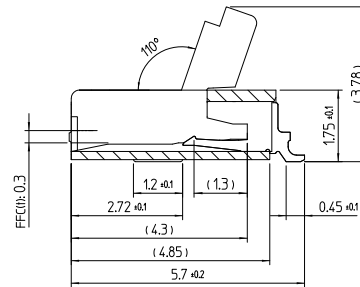
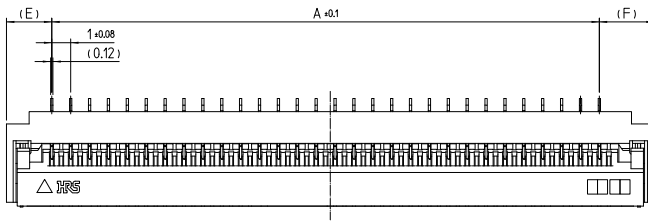

4-8Pos.

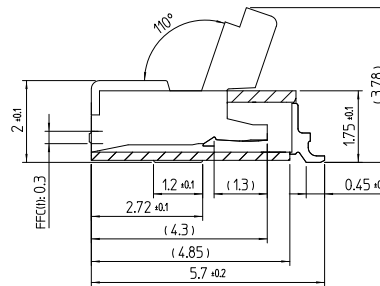
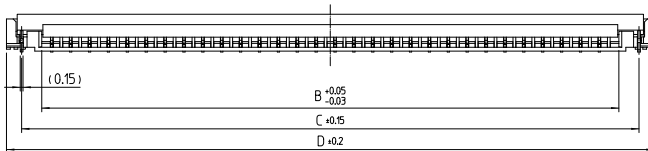

10-30Pos.

Note 1 : The coplanarity of each terminal lead is within 0.1mm.

Note 2 : This product is packaged and sold in tape and reel. Check the packaging specifications for details.

Note 3 : Sink mark reliefs may be added due to improvements.

Note 4 : Black spots may appear on the mold resin, but this does not affect product performance.

Additionally, the terminal plating may change color after reflow, however this does not represent a quality issue.

Unit : mm

Part No.	HRS No.	No. of contacts	A	B	C	D	E	F	Purchase Unit
TF31-10(4)SA-1SH(800)	480-0169-2 00	4	3.00	5.57	7.70	9.30	2.90	3.40	3,000pcs/Reel
TF31-6S-1SH(800)	480-0168-0 00	6	5.00	7.07	9.20	10.80	2.90	2.90	
TF31-8S-1SH(800)	480-0211-7 00	8	7.00	9.07	11.20	12.80	2.90	2.90	
TF31-10S-1SH(800)	480-0212-0 00	10	9.00	11.07	13.20	14.80	2.90	2.90	
TF31-12S-1SH(800)	Under planning	12	11.00	13.07	15.20	16.80	2.90	2.90	
TF31-32(16)SB-1SH(800)	480-0848-0 00	16	15.00	16.57	18.70	20.30	2.40	2.90	
TF31-17S-1SH(800)	Under planning	17	16.00	18.07	20.20	21.80	2.90	2.90	
TF31-40(20)SB-1SH(800)	480-0213-2 00	20	19.00	20.57	22.70	24.30	2.40	2.90	
TF31-22S-1SH(800)	Under planning	22	21.00	23.07	25.20	26.80	2.90	2.90	
TF31-26S-1SH(800)	480-0252-0 00	26	25.00	27.07	29.20	30.80	2.90	2.90	
TF31-27S-1SH(800)	Under planning	27	26.00	28.07	20.20	31.80	2.90	2.90	
TF31-60(30)SB-1SH(800)	480-0180-5 00	30	29.00	30.57	32.70	34.30	2.40	2.90	

Note 5 : Contact positions without HRS No. are currently under planning.

Please contact Hirose for detailed information about product variations.

Note 6 : HRS No. with (895) specification : 500pcs/Reel is currently under planning.

◆ Recommended FPC/FFC Dimensions and Land / Metal Mask Dimensions

● 0.5mm Pitch Product

FPC/FFC Dimensions				Land / Metal Mask Dimensions																																																																																																																																																																																																																																																			
<p>Unit : mm</p> <table border="1"> <thead> <tr> <th>Part No.</th> <th>A</th> <th>B</th> <th>C</th> </tr> </thead> <tbody> <tr><td>TF31-4S-0.5SH(###)</td><td>1.5</td><td>2.5</td><td>3.9</td></tr> <tr><td>TF31-6S-0.5SH(###)</td><td>2.5</td><td>3.5</td><td>4.9</td></tr> <tr><td>TF31-7S-0.5SH(###)</td><td>3.0</td><td>4.0</td><td>5.4</td></tr> <tr><td>TF31-8S-0.5SH(###)</td><td>3.5</td><td>4.5</td><td>5.9</td></tr> <tr><td>TF31-10S-0.5SH(###)</td><td>4.5</td><td>5.5</td><td>6.9</td></tr> <tr><td>TF31-12S-0.5SH(###)</td><td>5.5</td><td>6.5</td><td>7.9</td></tr> <tr><td>TF31-13S-0.5SH(###)</td><td>6.0</td><td>7.0</td><td>8.4</td></tr> <tr><td>TF31-14S-0.5SH(###)</td><td>6.5</td><td>7.5</td><td>8.9</td></tr> <tr><td>TF31-16S-0.5SH(###)</td><td>7.5</td><td>8.5</td><td>9.9</td></tr> <tr><td>TF31-17S-0.5SH(###)</td><td>8.0</td><td>9.0</td><td>10.4</td></tr> <tr><td>TF31-18S-0.5SH(###)</td><td>8.5</td><td>9.5</td><td>10.9</td></tr> <tr><td>TF31-20S-0.5SH(###)</td><td>9.5</td><td>10.5</td><td>11.9</td></tr> <tr><td>TF31-21S-0.5SH(###)</td><td>10.0</td><td>11.0</td><td>12.4</td></tr> <tr><td>TF31-22S-0.5SH(###)</td><td>10.5</td><td>11.5</td><td>12.9</td></tr> <tr><td>TF31-24S-0.5SH(###)</td><td>11.5</td><td>12.5</td><td>13.9</td></tr> <tr><td>TF31-25S-0.5SH(###)</td><td>12.0</td><td>13.0</td><td>14.4</td></tr> <tr><td>TF31-26S-0.5SH(###)</td><td>12.5</td><td>13.5</td><td>14.9</td></tr> <tr><td>TF31-28S-0.5SH(###)</td><td>13.5</td><td>14.5</td><td>15.9</td></tr> <tr><td>TF31-30S-0.5SH(###)</td><td>14.5</td><td>15.5</td><td>16.9</td></tr> <tr><td>TF31-32S-0.5SH(###)</td><td>15.5</td><td>16.5</td><td>17.9</td></tr> <tr><td>TF31-35S-0.5SH(###)</td><td>17.0</td><td>18.0</td><td>19.4</td></tr> <tr><td>TF31-36S-0.5SH(###)</td><td>17.5</td><td>18.5</td><td>19.9</td></tr> <tr><td>TF31-40S-0.5SH(###)</td><td>19.5</td><td>20.5</td><td>21.9</td></tr> <tr><td>TF31-45S-0.5SH(###)</td><td>22.0</td><td>23.0</td><td>24.4</td></tr> <tr><td>TF31-50S-0.5SH(###)</td><td>24.5</td><td>25.5</td><td>26.9</td></tr> <tr><td>TF31-53S-0.5SH(###)</td><td>26.0</td><td>27.0</td><td>28.4</td></tr> <tr><td>TF31-54S-0.5SH(###)</td><td>26.5</td><td>27.5</td><td>28.9</td></tr> <tr><td>TF31-55S-0.5SH(###)</td><td>27.0</td><td>28.0</td><td>29.4</td></tr> <tr><td>TF31-60S-0.5SH(###)</td><td>29.5</td><td>30.5</td><td>31.9</td></tr> </tbody> </table>				Part No.	A	B	C	TF31-4S-0.5SH(###)	1.5	2.5	3.9	TF31-6S-0.5SH(###)	2.5	3.5	4.9	TF31-7S-0.5SH(###)	3.0	4.0	5.4	TF31-8S-0.5SH(###)	3.5	4.5	5.9	TF31-10S-0.5SH(###)	4.5	5.5	6.9	TF31-12S-0.5SH(###)	5.5	6.5	7.9	TF31-13S-0.5SH(###)	6.0	7.0	8.4	TF31-14S-0.5SH(###)	6.5	7.5	8.9	TF31-16S-0.5SH(###)	7.5	8.5	9.9	TF31-17S-0.5SH(###)	8.0	9.0	10.4	TF31-18S-0.5SH(###)	8.5	9.5	10.9	TF31-20S-0.5SH(###)	9.5	10.5	11.9	TF31-21S-0.5SH(###)	10.0	11.0	12.4	TF31-22S-0.5SH(###)	10.5	11.5	12.9	TF31-24S-0.5SH(###)	11.5	12.5	13.9	TF31-25S-0.5SH(###)	12.0	13.0	14.4	TF31-26S-0.5SH(###)	12.5	13.5	14.9	TF31-28S-0.5SH(###)	13.5	14.5	15.9	TF31-30S-0.5SH(###)	14.5	15.5	16.9	TF31-32S-0.5SH(###)	15.5	16.5	17.9	TF31-35S-0.5SH(###)	17.0	18.0	19.4	TF31-36S-0.5SH(###)	17.5	18.5	19.9	TF31-40S-0.5SH(###)	19.5	20.5	21.9	TF31-45S-0.5SH(###)	22.0	23.0	24.4	TF31-50S-0.5SH(###)	24.5	25.5	26.9	TF31-53S-0.5SH(###)	26.0	27.0	28.4	TF31-54S-0.5SH(###)	26.5	27.5	28.9	TF31-55S-0.5SH(###)	27.0	28.0	29.4	TF31-60S-0.5SH(###)	29.5	30.5	31.9	<p>Recommended Metal Mask Thickness : 0.12mm</p> <p>Unit : mm</p> <table border="1"> <thead> <tr> <th>Part No.</th> <th>A</th> <th>B</th> <th>C</th> </tr> </thead> <tbody> <tr><td>TF31-4S-0.5SH(###)</td><td>1.5</td><td>3.5</td><td>7.3</td></tr> <tr><td>TF31-6S-0.5SH(###)</td><td>2.5</td><td>4.5</td><td>8.3</td></tr> <tr><td>TF31-7S-0.5SH(###)</td><td>3.0</td><td>5.0</td><td>8.8</td></tr> <tr><td>TF31-8S-0.5SH(###)</td><td>3.5</td><td>5.5</td><td>9.3</td></tr> <tr><td>TF31-10S-0.5SH(###)</td><td>4.5</td><td>6.5</td><td>10.3</td></tr> <tr><td>TF31-12S-0.5SH(###)</td><td>5.5</td><td>7.5</td><td>11.3</td></tr> <tr><td>TF31-13S-0.5SH(###)</td><td>6.0</td><td>8.0</td><td>11.8</td></tr> <tr><td>TF31-14S-0.5SH(###)</td><td>6.5</td><td>8.5</td><td>12.3</td></tr> <tr><td>TF31-16S-0.5SH(###)</td><td>7.5</td><td>9.5</td><td>13.3</td></tr> <tr><td>TF31-17S-0.5SH(###)</td><td>8.0</td><td>10.0</td><td>13.8</td></tr> <tr><td>TF31-18S-0.5SH(###)</td><td>8.5</td><td>10.5</td><td>14.3</td></tr> <tr><td>TF31-20S-0.5SH(###)</td><td>9.5</td><td>11.5</td><td>15.3</td></tr> <tr><td>TF31-21S-0.5SH(###)</td><td>10.0</td><td>12.0</td><td>15.8</td></tr> <tr><td>TF31-22S-0.5SH(###)</td><td>10.5</td><td>12.5</td><td>16.3</td></tr> <tr><td>TF31-24S-0.5SH(###)</td><td>11.5</td><td>13.5</td><td>17.3</td></tr> <tr><td>TF31-25S-0.5SH(###)</td><td>12.0</td><td>14.0</td><td>17.8</td></tr> <tr><td>TF31-26S-0.5SH(###)</td><td>12.5</td><td>14.5</td><td>18.3</td></tr> <tr><td>TF31-28S-0.5SH(###)</td><td>13.5</td><td>15.5</td><td>19.3</td></tr> <tr><td>TF31-30S-0.5SH(###)</td><td>14.5</td><td>16.5</td><td>20.3</td></tr> <tr><td>TF31-32S-0.5SH(###)</td><td>15.5</td><td>17.5</td><td>21.3</td></tr> <tr><td>TF31-35S-0.5SH(###)</td><td>17.0</td><td>19.0</td><td>22.8</td></tr> <tr><td>TF31-36S-0.5SH(###)</td><td>17.5</td><td>19.5</td><td>23.3</td></tr> <tr><td>TF31-40S-0.5SH(###)</td><td>19.5</td><td>21.5</td><td>25.3</td></tr> <tr><td>TF31-45S-0.5SH(###)</td><td>22.0</td><td>24.0</td><td>27.8</td></tr> <tr><td>TF31-50S-0.5SH(###)</td><td>24.5</td><td>26.5</td><td>30.3</td></tr> <tr><td>TF31-53S-0.5SH(###)</td><td>26.0</td><td>28.0</td><td>31.8</td></tr> <tr><td>TF31-54S-0.5SH(###)</td><td>26.5</td><td>28.5</td><td>32.3</td></tr> <tr><td>TF31-55S-0.5SH(###)</td><td>27.0</td><td>29.0</td><td>32.8</td></tr> <tr><td>TF31-60S-0.5SH(###)</td><td>29.5</td><td>31.5</td><td>35.3</td></tr> </tbody> </table>				Part No.	A	B	C	TF31-4S-0.5SH(###)	1.5	3.5	7.3	TF31-6S-0.5SH(###)	2.5	4.5	8.3	TF31-7S-0.5SH(###)	3.0	5.0	8.8	TF31-8S-0.5SH(###)	3.5	5.5	9.3	TF31-10S-0.5SH(###)	4.5	6.5	10.3	TF31-12S-0.5SH(###)	5.5	7.5	11.3	TF31-13S-0.5SH(###)	6.0	8.0	11.8	TF31-14S-0.5SH(###)	6.5	8.5	12.3	TF31-16S-0.5SH(###)	7.5	9.5	13.3	TF31-17S-0.5SH(###)	8.0	10.0	13.8	TF31-18S-0.5SH(###)	8.5	10.5	14.3	TF31-20S-0.5SH(###)	9.5	11.5	15.3	TF31-21S-0.5SH(###)	10.0	12.0	15.8	TF31-22S-0.5SH(###)	10.5	12.5	16.3	TF31-24S-0.5SH(###)	11.5	13.5	17.3	TF31-25S-0.5SH(###)	12.0	14.0	17.8	TF31-26S-0.5SH(###)	12.5	14.5	18.3	TF31-28S-0.5SH(###)	13.5	15.5	19.3	TF31-30S-0.5SH(###)	14.5	16.5	20.3	TF31-32S-0.5SH(###)	15.5	17.5	21.3	TF31-35S-0.5SH(###)	17.0	19.0	22.8	TF31-36S-0.5SH(###)	17.5	19.5	23.3	TF31-40S-0.5SH(###)	19.5	21.5	25.3	TF31-45S-0.5SH(###)	22.0	24.0	27.8	TF31-50S-0.5SH(###)	24.5	26.5	30.3	TF31-53S-0.5SH(###)	26.0	28.0	31.8	TF31-54S-0.5SH(###)	26.5	28.5	32.3	TF31-55S-0.5SH(###)	27.0	29.0	32.8	TF31-60S-0.5SH(###)	29.5	31.5	35.3
Part No.	A	B	C																																																																																																																																																																																																																																																				
TF31-4S-0.5SH(###)	1.5	2.5	3.9																																																																																																																																																																																																																																																				
TF31-6S-0.5SH(###)	2.5	3.5	4.9																																																																																																																																																																																																																																																				
TF31-7S-0.5SH(###)	3.0	4.0	5.4																																																																																																																																																																																																																																																				
TF31-8S-0.5SH(###)	3.5	4.5	5.9																																																																																																																																																																																																																																																				
TF31-10S-0.5SH(###)	4.5	5.5	6.9																																																																																																																																																																																																																																																				
TF31-12S-0.5SH(###)	5.5	6.5	7.9																																																																																																																																																																																																																																																				
TF31-13S-0.5SH(###)	6.0	7.0	8.4																																																																																																																																																																																																																																																				
TF31-14S-0.5SH(###)	6.5	7.5	8.9																																																																																																																																																																																																																																																				
TF31-16S-0.5SH(###)	7.5	8.5	9.9																																																																																																																																																																																																																																																				
TF31-17S-0.5SH(###)	8.0	9.0	10.4																																																																																																																																																																																																																																																				
TF31-18S-0.5SH(###)	8.5	9.5	10.9																																																																																																																																																																																																																																																				
TF31-20S-0.5SH(###)	9.5	10.5	11.9																																																																																																																																																																																																																																																				
TF31-21S-0.5SH(###)	10.0	11.0	12.4																																																																																																																																																																																																																																																				
TF31-22S-0.5SH(###)	10.5	11.5	12.9																																																																																																																																																																																																																																																				
TF31-24S-0.5SH(###)	11.5	12.5	13.9																																																																																																																																																																																																																																																				
TF31-25S-0.5SH(###)	12.0	13.0	14.4																																																																																																																																																																																																																																																				
TF31-26S-0.5SH(###)	12.5	13.5	14.9																																																																																																																																																																																																																																																				
TF31-28S-0.5SH(###)	13.5	14.5	15.9																																																																																																																																																																																																																																																				
TF31-30S-0.5SH(###)	14.5	15.5	16.9																																																																																																																																																																																																																																																				
TF31-32S-0.5SH(###)	15.5	16.5	17.9																																																																																																																																																																																																																																																				
TF31-35S-0.5SH(###)	17.0	18.0	19.4																																																																																																																																																																																																																																																				
TF31-36S-0.5SH(###)	17.5	18.5	19.9																																																																																																																																																																																																																																																				
TF31-40S-0.5SH(###)	19.5	20.5	21.9																																																																																																																																																																																																																																																				
TF31-45S-0.5SH(###)	22.0	23.0	24.4																																																																																																																																																																																																																																																				
TF31-50S-0.5SH(###)	24.5	25.5	26.9																																																																																																																																																																																																																																																				
TF31-53S-0.5SH(###)	26.0	27.0	28.4																																																																																																																																																																																																																																																				
TF31-54S-0.5SH(###)	26.5	27.5	28.9																																																																																																																																																																																																																																																				
TF31-55S-0.5SH(###)	27.0	28.0	29.4																																																																																																																																																																																																																																																				
TF31-60S-0.5SH(###)	29.5	30.5	31.9																																																																																																																																																																																																																																																				
Part No.	A	B	C																																																																																																																																																																																																																																																				
TF31-4S-0.5SH(###)	1.5	3.5	7.3																																																																																																																																																																																																																																																				
TF31-6S-0.5SH(###)	2.5	4.5	8.3																																																																																																																																																																																																																																																				
TF31-7S-0.5SH(###)	3.0	5.0	8.8																																																																																																																																																																																																																																																				
TF31-8S-0.5SH(###)	3.5	5.5	9.3																																																																																																																																																																																																																																																				
TF31-10S-0.5SH(###)	4.5	6.5	10.3																																																																																																																																																																																																																																																				
TF31-12S-0.5SH(###)	5.5	7.5	11.3																																																																																																																																																																																																																																																				
TF31-13S-0.5SH(###)	6.0	8.0	11.8																																																																																																																																																																																																																																																				
TF31-14S-0.5SH(###)	6.5	8.5	12.3																																																																																																																																																																																																																																																				
TF31-16S-0.5SH(###)	7.5	9.5	13.3																																																																																																																																																																																																																																																				
TF31-17S-0.5SH(###)	8.0	10.0	13.8																																																																																																																																																																																																																																																				
TF31-18S-0.5SH(###)	8.5	10.5	14.3																																																																																																																																																																																																																																																				
TF31-20S-0.5SH(###)	9.5	11.5	15.3																																																																																																																																																																																																																																																				
TF31-21S-0.5SH(###)	10.0	12.0	15.8																																																																																																																																																																																																																																																				
TF31-22S-0.5SH(###)	10.5	12.5	16.3																																																																																																																																																																																																																																																				
TF31-24S-0.5SH(###)	11.5	13.5	17.3																																																																																																																																																																																																																																																				
TF31-25S-0.5SH(###)	12.0	14.0	17.8																																																																																																																																																																																																																																																				
TF31-26S-0.5SH(###)	12.5	14.5	18.3																																																																																																																																																																																																																																																				
TF31-28S-0.5SH(###)	13.5	15.5	19.3																																																																																																																																																																																																																																																				
TF31-30S-0.5SH(###)	14.5	16.5	20.3																																																																																																																																																																																																																																																				
TF31-32S-0.5SH(###)	15.5	17.5	21.3																																																																																																																																																																																																																																																				
TF31-35S-0.5SH(###)	17.0	19.0	22.8																																																																																																																																																																																																																																																				
TF31-36S-0.5SH(###)	17.5	19.5	23.3																																																																																																																																																																																																																																																				
TF31-40S-0.5SH(###)	19.5	21.5	25.3																																																																																																																																																																																																																																																				
TF31-45S-0.5SH(###)	22.0	24.0	27.8																																																																																																																																																																																																																																																				
TF31-50S-0.5SH(###)	24.5	26.5	30.3																																																																																																																																																																																																																																																				
TF31-53S-0.5SH(###)	26.0	28.0	31.8																																																																																																																																																																																																																																																				
TF31-54S-0.5SH(###)	26.5	28.5	32.3																																																																																																																																																																																																																																																				
TF31-55S-0.5SH(###)	27.0	29.0	32.8																																																																																																																																																																																																																																																				
TF31-60S-0.5SH(###)	29.5	31.5	35.3																																																																																																																																																																																																																																																				

● 1.0mm Pitch Product

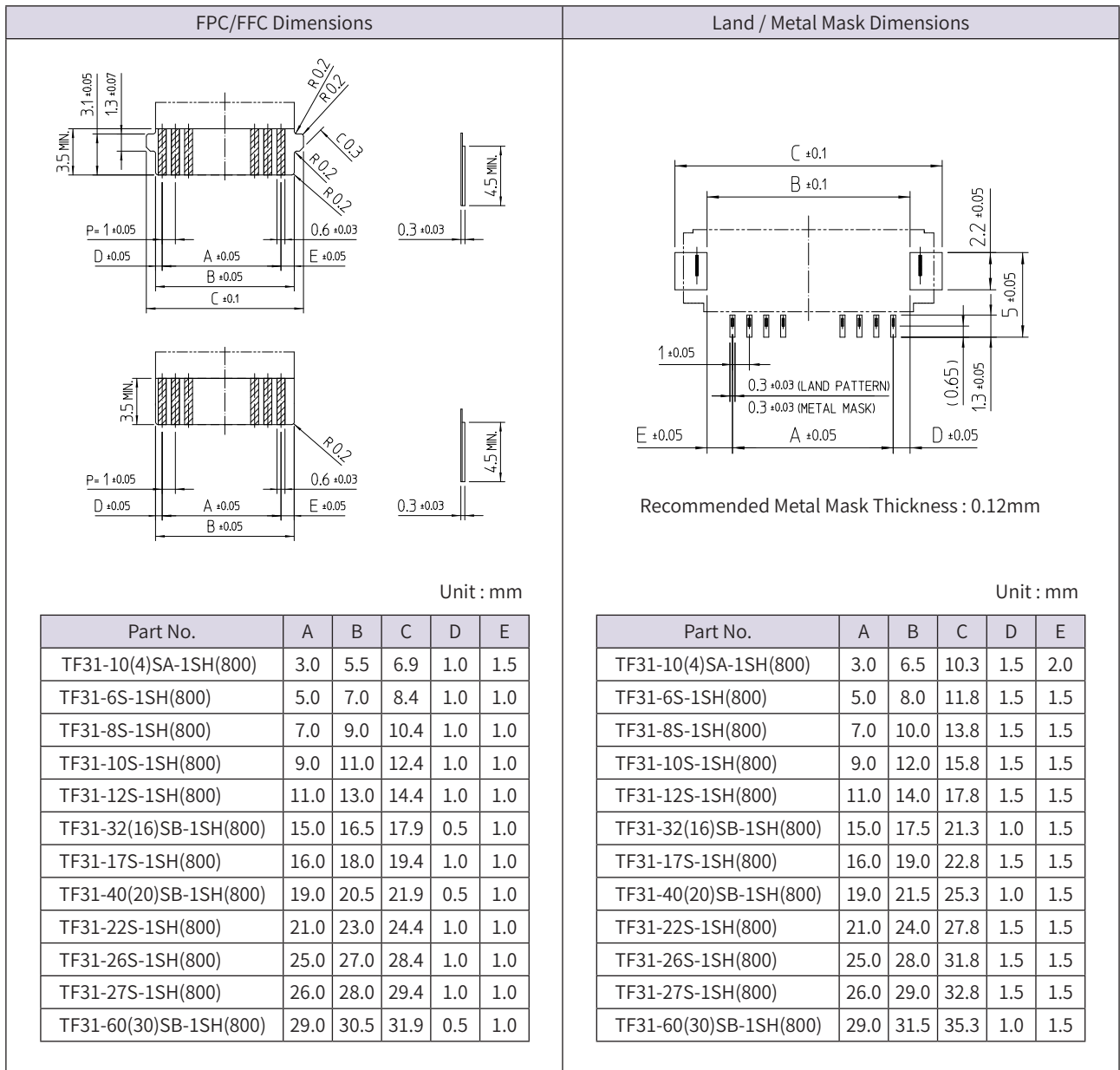

◆ Packaging Specification

● Embossed Carrier Tape Dimensions (Tape Width 24mm Max.)

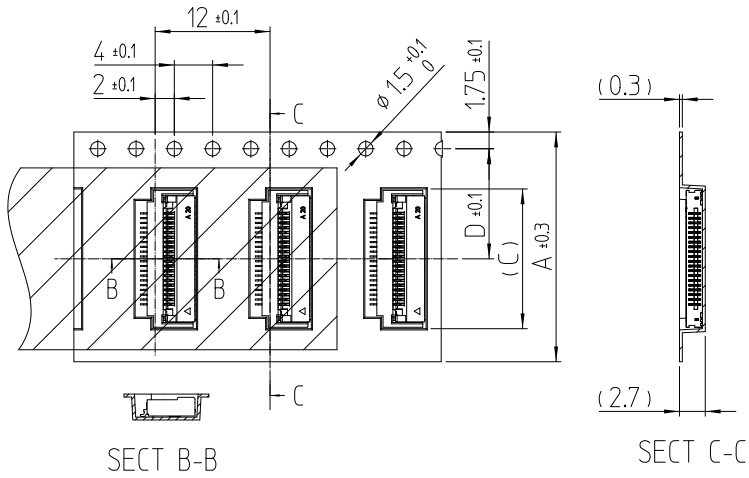

● Embossed Carrier Tape Dimensions (Tape Width 32mm Min.)

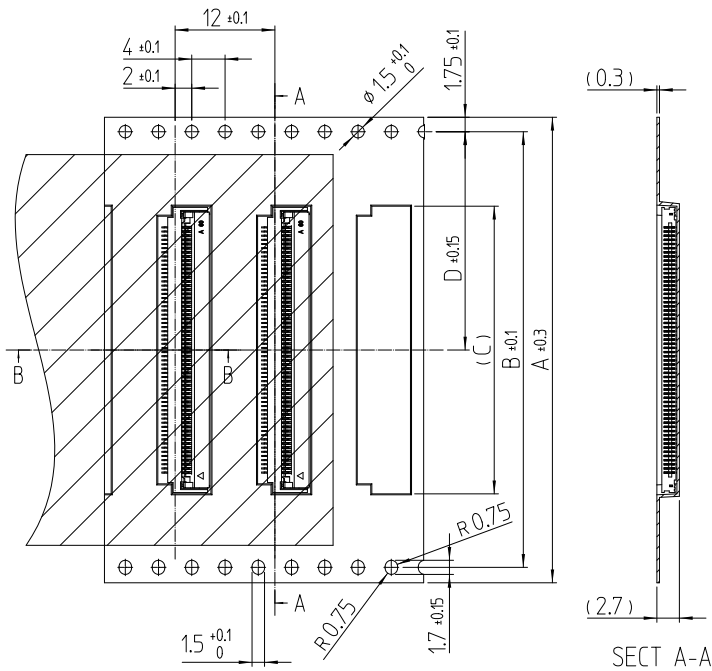

● Reel Dimensions

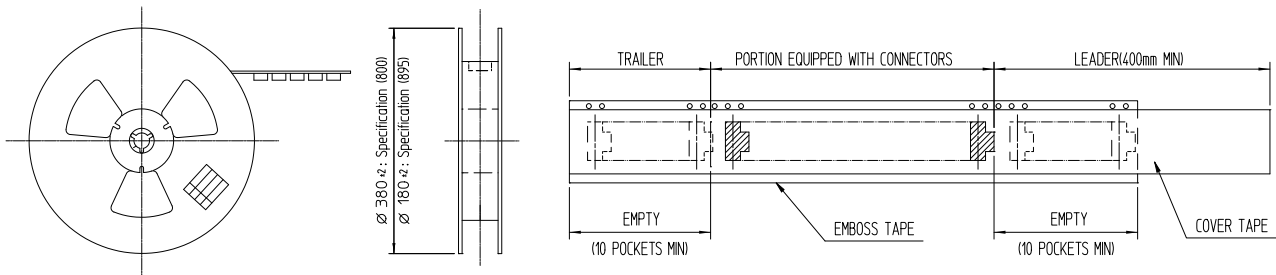

Note 1 : 3,000pcs / Reel (Reel Outer Diameter: $\phi 380 \pm 2\text{mm}$), 500pcs / Reel (Reel Outer Diameter: $\phi 180 \pm 2\text{mm}$)

Note 2 : Material

- 1) Emboss Tape : Tape width 24mm Max. : PS (Antistatic Treatment), Tape width 32mm Min. : PET (Antistatic Treatment)
- 2) Cover Tape : PET (Antistatic Treatment)

[0.5mm Pitch Product]

Unit : mm

Part No.	A	B	C	D
TF31-4S-0.5SH(###)	16	-	6.6	7.5
TF31-6S-0.5SH(###)	16	-	7.6	7.5
TF31-7S-0.5SH(###)	16	-	8.1	7.5
TF31-8S-0.5SH(###)	16	-	8.6	7.5
TF31-10S-0.5SH(###)	16	-	9.6	7.5
TF31-12S-0.5SH(###)	24	-	10.6	11.5
TF31-13S-0.5SH(###)	24	-	11.1	11.5
TF31-14S-0.5SH(###)	24	-	11.6	11.5
TF31-16S-0.5SH(###)	24	-	12.6	11.5
TF31-17S-0.5SH(###)	24	-	13.1	11.5
TF31-18S-0.5SH(###)	24	-	13.6	11.5
TF31-20S-0.5SH(###)	24	-	14.6	11.5
TF31-21S-0.5SH(###)	32	28.4	15.1	14.2
TF31-22S-0.5SH(###)	32	28.4	15.6	14.2
TF31-24S-0.5SH(###)	32	28.4	16.6	14.2
TF31-25S-0.5SH(###)	32	28.4	17.1	14.2
TF31-26S-0.5SH(###)	32	28.4	17.6	14.2
TF31-28S-0.5SH(###)	32	28.4	18.6	14.2
TF31-30S-0.5SH(###)	32	28.4	19.6	14.2
TF31-32S-0.5SH(###)	32	28.4	20.6	14.2
TF31-35S-0.5SH(###)	44	40.4	22.1	20.2
TF31-36S-0.5SH(###)	44	40.4	22.6	20.2
TF31-40S-0.5SH(###)	44	40.4	24.6	20.2
TF31-45S-0.5SH(###)	44	40.4	27.1	20.2
TF31-50S-0.5SH(###)	44	40.4	29.6	20.2
TF31-53S-0.5SH(###)	44	40.4	31.1	20.2
TF31-54S-0.5SH(###)	44	40.4	31.6	20.2
TF31-55S-0.5SH(###)	44	40.4	32.1	20.2
TF31-60S-0.5SH(###)	56	52.4	34.6	26.2

[1.0mm Pitch Product]

Unit : mm

Part No.	A	B	C	D
TF31-10(4)SA-1SH(800)	16	-	9.6	7.5
TF31-6S-1SH(800)	24	-	11.1	11.5
TF31-8S-1SH(800)	24	-	13.1	11.5
TF31-10S-1SH(800)	32	28.4	15.1	14.2
TF31-12S-1SH(800)	32	28.4	17.1	14.2
TF31-17S-1SH(800)	44	40.4	22.1	20.2
TF31-32(16)SB-1SH(800)	32	28.4	20.6	14.2
TF31-40(20)SB-1SH(800)	44	40.4	24.6	20.2
TF31-22S-1SH(800)	44	40.4	27.1	20.2
TF31-26S-1SH(800)	44	40.4	31.1	20.2
TF31-27S-1SH(800)	44	40.4	32.1	20.2
TF31-60(30)SB-1SH(800)	56	52.4	34.6	26.2

◆ TF31 Series FPC/FFC Construction (Recommended Specifications)

● FPC : Flexible Printed Circuit

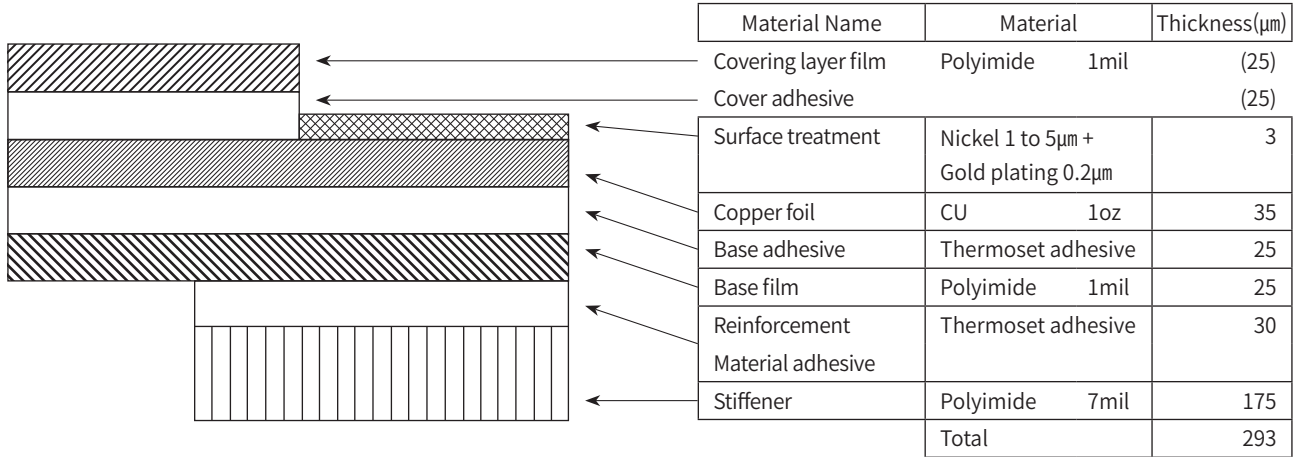

● FFC : Flexible Flat Cable

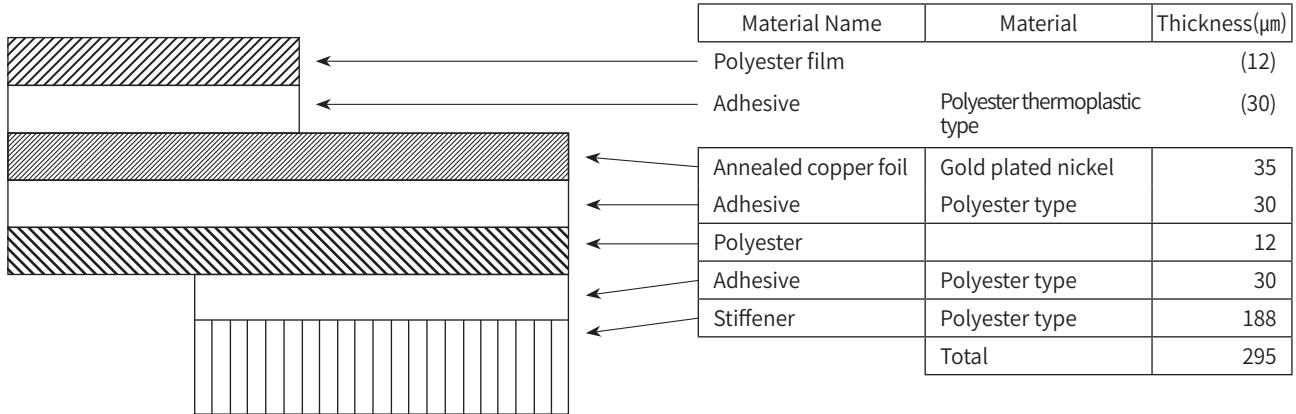

Note 1 : This specification is recommended for the component configuration of the TF31 Series FPC and FFC (t=0.3±0.03mm)
 Note 2 : For details about component configuration, please contact a FPC/FFC manufacturer.

◆ Recommended Temperature Profile

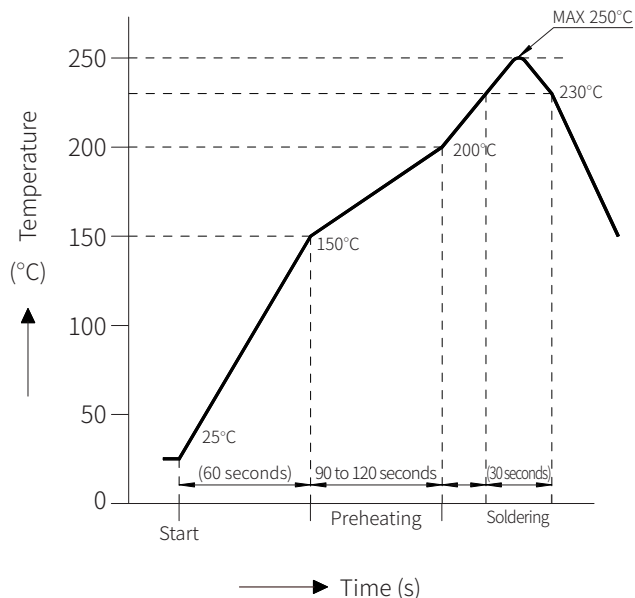

HRS Test Conditions

Reflow method : Reflow, IR/hot air
 Reflow Environment : Room air
 Solder Composition : Paste, 96.5%Sn/3%Ag/0.5%Cu
 (M705-221CM5-32-10.5 from Senju Metal Industry Co., Ltd.)

Test Board : Glass epoxy 40mm×80mm×1.6mm thick
 Land Dimensions : 0.3mm×1.3mm
 Metal Mask : 0.3mm×1.3mm×0.12mm thick

The temperature profile is based on the above conditions. Please check the mounting conditions before use, conditions such as solder paste types, manufacturer, PCB size and any other soldering materials may alter the performance of such materials.

◆ Connector Operation and Precautions

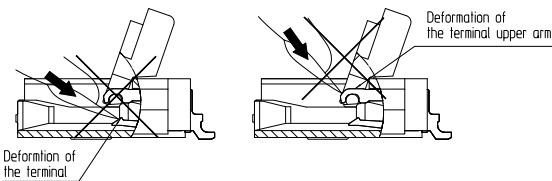
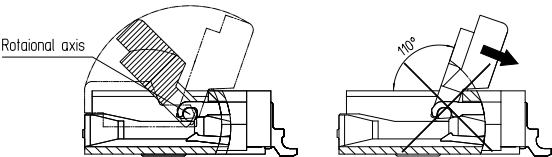
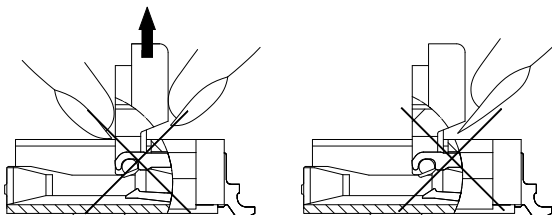
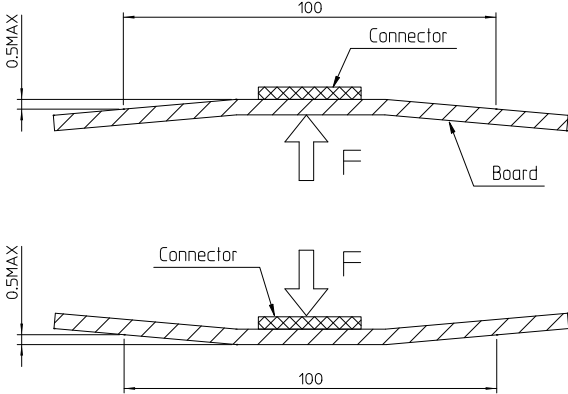
Board Mounting Precautions	FPC/FFC Insertion/Mating Precautions
<p>● Board Warpage</p> <p>Be sure to minimize the board warpage as much as possible. The lead co-planarity is 0.1mm or less. Excessive board warpage may result in soldering failures or co-planarity issues.</p> <p>● Connector Load</p> <p>If the connector is not mounted onto a board, refrain from doing any of the following actions: Do not apply a force of 0.5N or more to the connector. Do not insert the FFC or operate the connector. Any of these actions may damage or break the connector.</p>	<p>● Actuator Operation</p> <ol style="list-style-type: none"> Do not apply excessive force on the actuator when releasing it from its initial position. Using a nail or finger as shown below, may result in terminal deformation.  <ol style="list-style-type: none"> The actuator rotates around the axis as shown below. Make sure to rotate the whole actuator and not just the center portion. The actuator opens up to 110°. Do not force the actuator beyond this point. Doing so may result in actuator damage or breakage.  <ol style="list-style-type: none"> Operate the actuator towards the center. Operating one side only may result in actuator damage or incomplete mating. Do not pull or pick at the actuator. Doing so may damage it. (Do not carry out any operation other than the actuator rotation operation described in 2.)  <p>● Contact Orientation</p> <p>This connector utilizes bottom contacts. Insert the FPC/FFC with the exposed conductors face down.</p>
Instruction after mounting on the board	
<p>● Board Stress</p> <p>It may be advisable to split larger boards into smaller sections to reduce overall board stress. Avoid placing any excess force on the board during the assembly process. When using screws to secure the boards, be sure to check for any unwanted stress that may occur from this operation as well.</p> <p>● Acceptable Amount of Board Warpage</p> <p>A 100 mm wide board has an acceptable warp range of 0.5mm or less. (Below) Excessive amounts of warping will place stress on the connector which may result in damage and malfunction.</p> 	

Feb. 1. 2023 Copyright 2023 HIROSE ELECTRIC CO., LTD. All Rights Reserved.

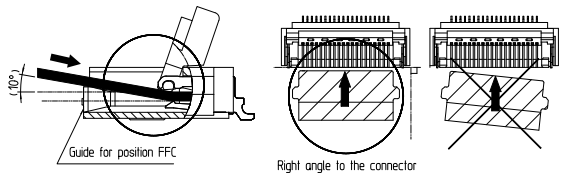
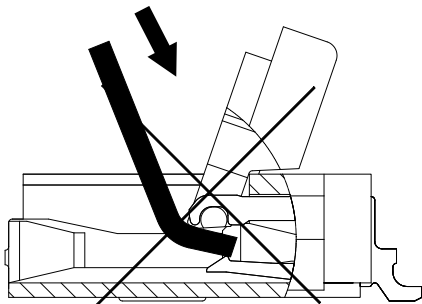
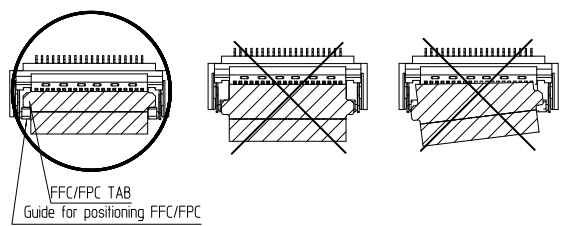
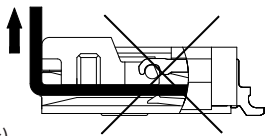
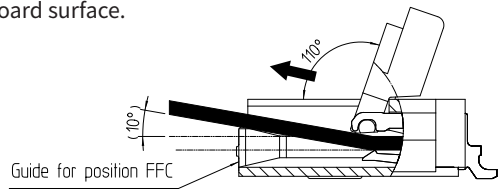
FPC/FFC Insertion/Mating Precautions	FPC/FFC Insertion/Mating Precautions						
<p>● Inserting the FPC/FFC</p> <ol style="list-style-type: none"> 1. There is a FPC/FFC positioning guide. Insert the FPC/FFC straight into the connector while at a 10° angle to the board surface (see illustration below). Make sure that it has been fully inserted.  <ol style="list-style-type: none"> 2. Do not insert the FPC/FFC diagonally. If the FPC/FFC is inserted in skewed orientation as illustrated above, the FPC/FFC may get caught by the terminals resulting in terminal deformation. <p>Additionally the FPC/FFC may be bent, resulting in pattern breakage or insufficient insertion which may cause conduction failure.</p> <p>*Secure sufficient FPC/FFC insertion space during layout design to prevent diagonal FPC/FFC insertion. Additionally if the FPC/FFC is too short, it may be difficult to insert. Arrange appropriate parts during layout.</p> <p>*Consult with your FPC/FFC manufacturer to select a flex circuit that has the correct flex characteristics to avoid breakage.</p>  <ol style="list-style-type: none"> 3. After FPC/FFC insertion make sure that the FPC/FFC positioning tabs are properly aligned. Locking the actuator with the FPC/FFC tab on the guides may result in contact failure. 	<p>● Ensuring a Completed Connection</p> <p>After completing the locking operation, be sure to check that the actuator is horizontal to the board surface. Do not apply excessive force when the actuator reaches 0°, doing so may damage the terminals.</p> <tr> <th colspan="2" data-bbox="794 465 1444 519">Instructions on FPC/FFC layout after Mating</th> </tr> <p>● Load to FPC/FFC</p> <p>Do not apply direct force to the connector during FPC/FFC routing. Contact failure, disconnection or breakage may occur when using a FPC/FFC bent near the connector. In general the FPC/FFC should not be bent sharply near the insertion opening. Secure the FPC/FFC when applying a continuous load.</p>  <p>Load : 0.1 x n N Max. (n : number of contacts)</p> <tr> <th colspan="2" data-bbox="794 907 1444 963">FPC/FFC Removal Precautions</th> </tr> <p>● Release the actuator near the center. Operating one side only may result in actuator damage or incomplete mating.</p> <p>● Remove the FPC/FFC with the actuator released. There is a FPC/FFC positioning guide. Pull the FPC/FFC straight out of the connector at a 10° angle to the board surface.</p>  <tr> <th colspan="2" data-bbox="794 1444 1444 1500">Other Precautions</th> </tr> <p>● Manual Soldering</p> <p>Follow the instructions shown below when soldering the connector manually during repair work, etc.</p> <ol style="list-style-type: none"> 1. Do not perform reflow soldering or manual soldering with the FPC/FFC inserted into the connector. 2. Do not overheat the connector. Do not allow the soldering iron to contact any part other than the intended connector leads. Unnecessary contact may lead to damage and deformities of the connector. 3. Do not use excessive solder (flux). If excessive solder (flux) is used on the terminals, solder or flux may adhere to the contacts or rotating parts of the actuator, resulting in poor contact or a rotation failure of the actuator. 	Instructions on FPC/FFC layout after Mating		FPC/FFC Removal Precautions		Other Precautions	
Instructions on FPC/FFC layout after Mating							
FPC/FFC Removal Precautions							
Other Precautions							

◆ While taking in consideration

Specifications mentioned in this catalog are reference values.

When considering to order or use this product, please confirm the "Drawing" and "Product Specifications" sheets.

Use an appropriate cable when using the connector in combination with cables.

If considering usage of a non-specified cable, please contact your sales representative.

If assembly process is done by jigs & tools which are not identified by Hirose assurance will not be given.

If considering usage for below mentioned applications, please contact your sales representative.

In cases where the application will demand a high level of reliability, such as automotive, medical instruments, public infrastructure, aerospace/ defense etc. Hirose must review before assurance of reliability can be given.