

May.1.2026 Copyright 2026 HIROSE ELECTRIC CO., LTD. All Rights Reserved.
In case of consideration for using Automotive equipment / device which demand high reliability, kindly contact our sales window correspondents.

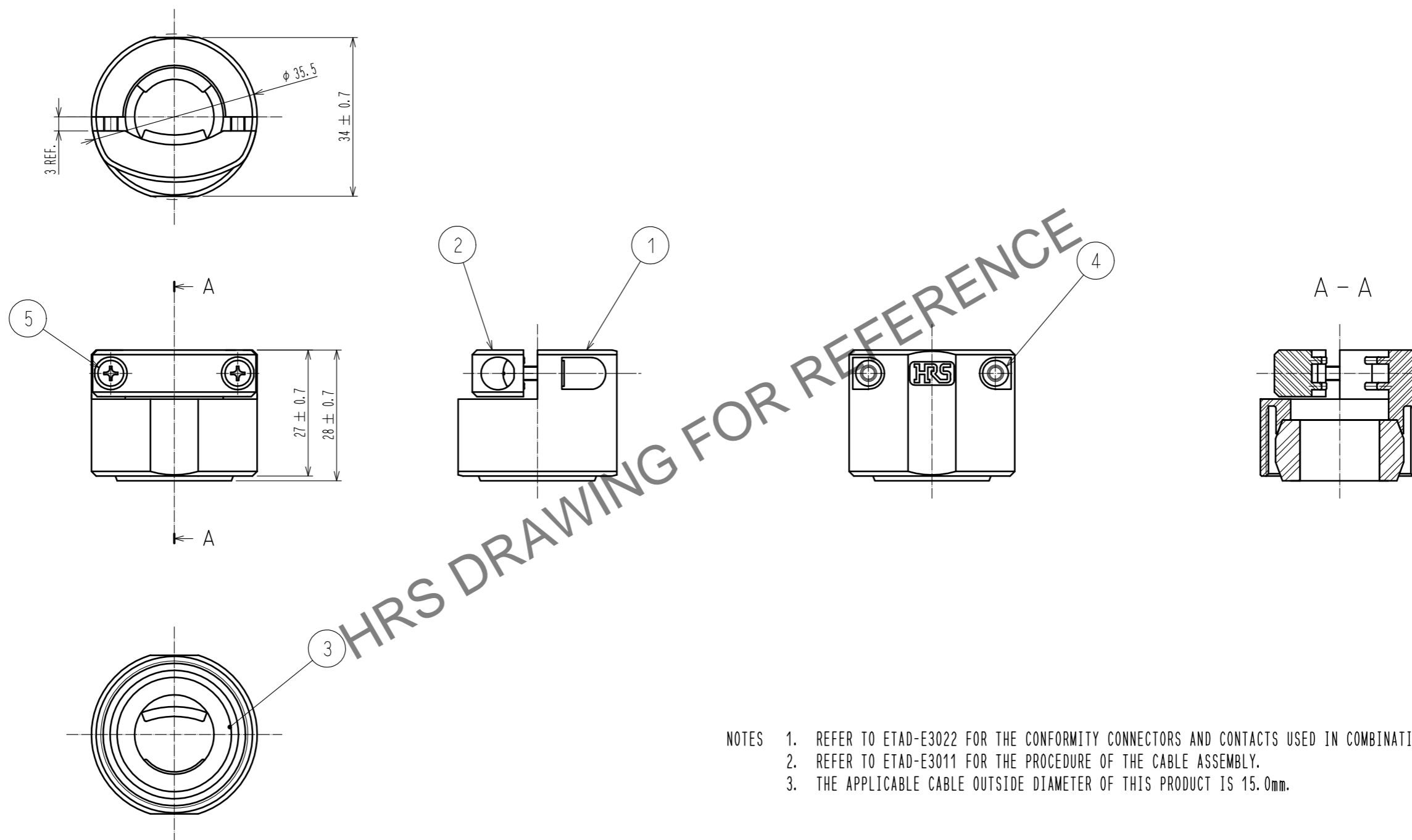

HRS DRAWING FOR REFERENCE

- NOTES
1. REFER TO ETAD-E3022 FOR THE CONFORMITY CONNECTORS AND CONTACTS USED IN COMBINATION WITH THIS PRODUCT.
 2. REFER TO ETAD-E3011 FOR THE PROCEDURE OF THE CABLE ASSEMBLY.
 3. THE APPLICABLE CABLE OUTSIDE DIAMETER OF THIS PRODUCT IS 15.0mm.

NO.	MATERIAL	FINISH . REMARKS	NO.	MATERIAL	FINISH . REMARKS
2	PPS	BLACK. UL94V-0	5	BRASS Δ	NICKEL PLATING
1	PPS	BLACK. UL94V-0	4	BRASS Δ	NICKEL PLATING
			3	NBR	BLACK

UNITS	SCALE	COUNT	DESCRIPTION OF REVISIONS	DESIGNED	CHECKED	DATE
mm	1 : 1	Δ 2	DIS-E-00005696	HY. MATSUDA	KG. OKITA	20210531

HRS HIROSE ELECTRIC CO., LTD.	APPROVED : NM. NISHIMATSU	20170124	DRAWING NO.	EDC-129312-00-00
	CHECKED : NM. NISHIMATSU	20170124	PART NO.	PQW-CM(15.0)
	DESIGNED : P. EKSOURIYA	20170124	CODE NO.	CL0236-2104-0-00
	DRAWN : P. EKSOURIYA	20170124		

May.1.2026 Copyright 2026 HIROSE ELECTRIC CO., LTD. All Rights Reserved.
In case of consideration for using Automotive equipment / device which demand high reliability, kindly contact our sales window correspondents.

ASSEMBLY STATE OF REFERENCE No. 1 AND 4

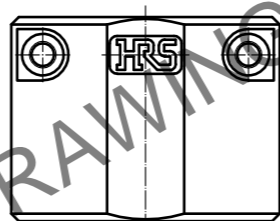
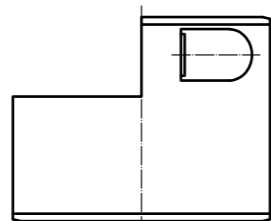
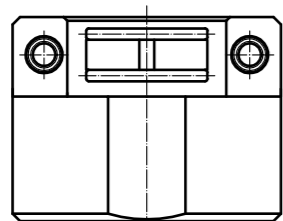
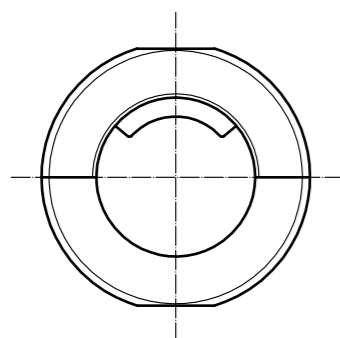

REFERECNE No. 2

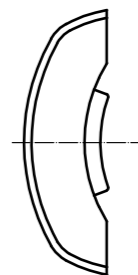

REFERENCE No. 3

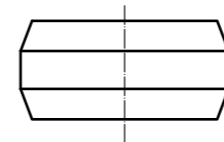
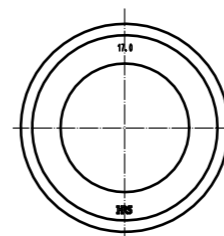

REFERENCE No. 5

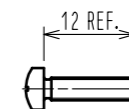

HRS	DRAWING NO.	EDC-129312-00-00
	PART NO.	PQW-CM<15.0>
	CODE NO.	CL0236-2104-0-00