

Jan. 1. 2025 Copyright © 2025 HIROSE ELECTRIC CO., LTD. All Rights Reserved.
 本製品を車載用途などの高い信頼性が求められる機器にご使用の場合は、弊社までお問合せ下さい。

△数 COUNT	訂正事項 DESCRIPTION OF REVISIONS	擔當 B Y	檢圖 CHKD	年月日 DATE	△数 COUNT	訂正事項 DESCRIPTION OF REVISIONS	擔當 B Y	檢圖 CHKD	年月日 DATE
△					△				
△					△				
△					△				

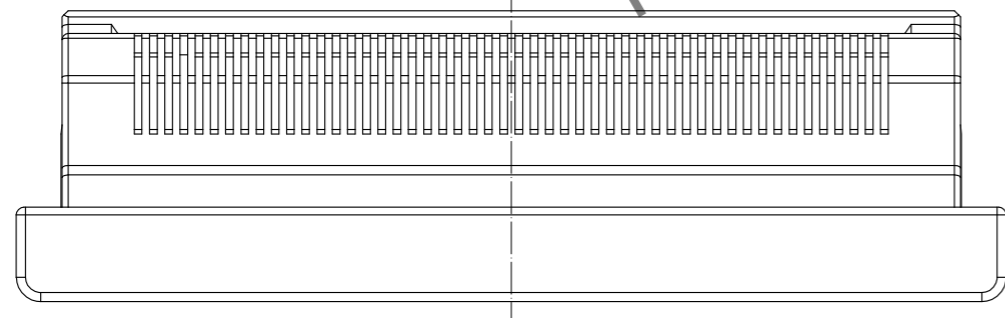

ISO-VIEW

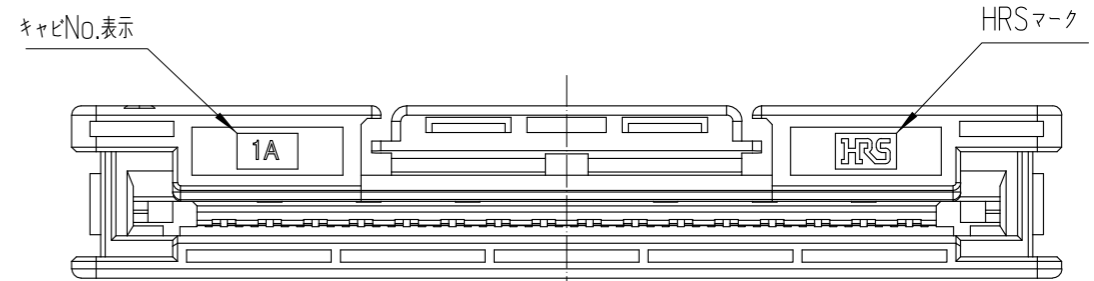
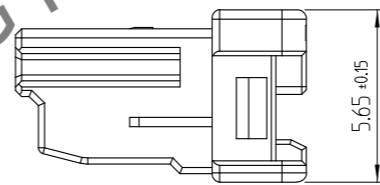
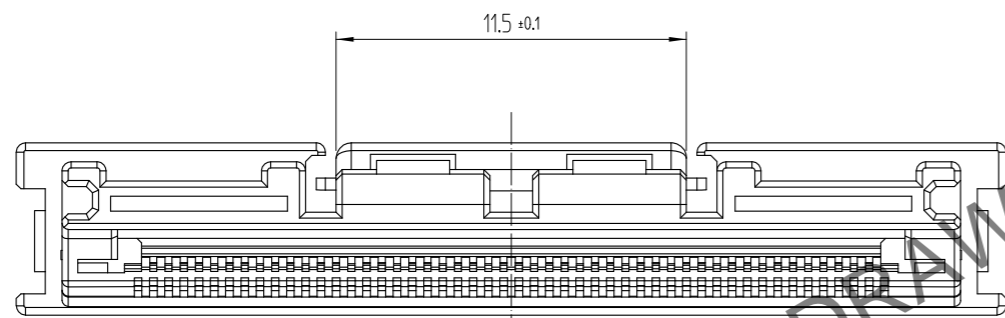
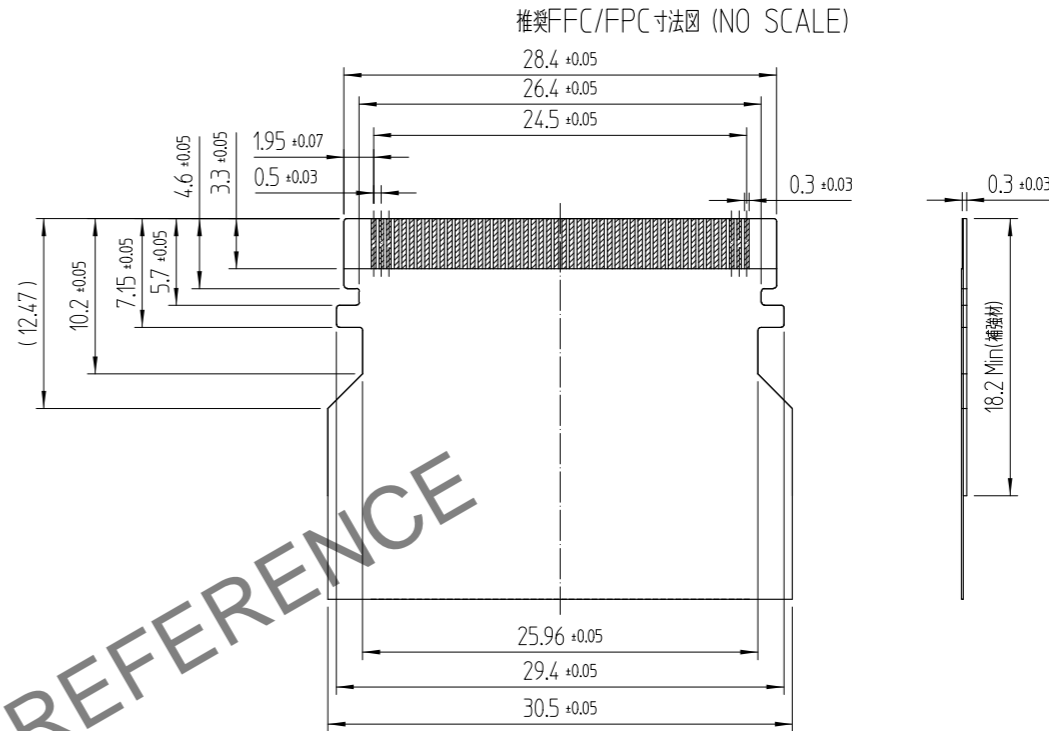
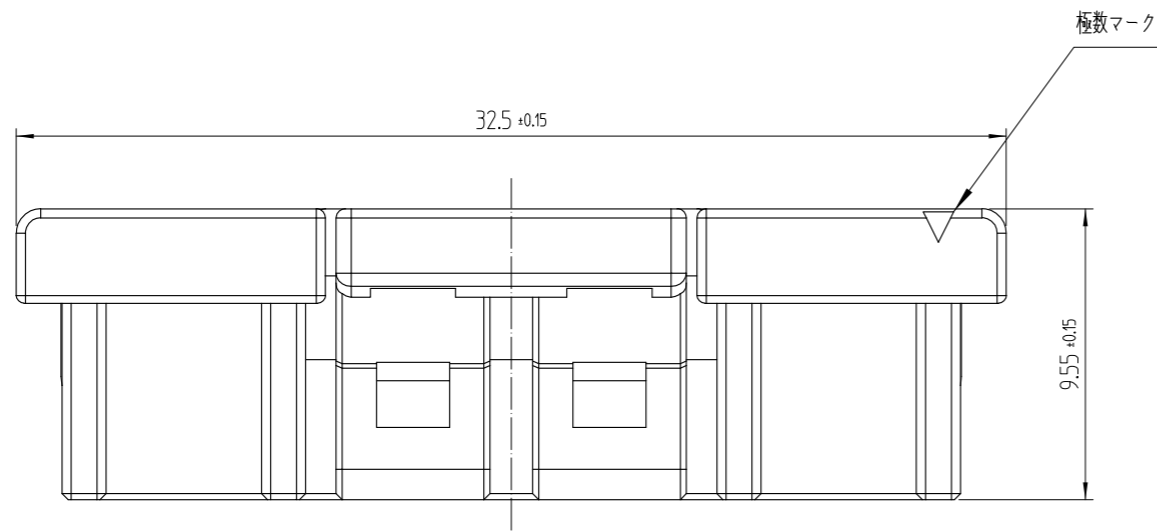
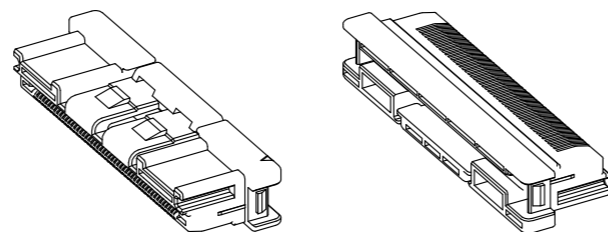

注1 梱包数量: 300pcs/bag

部番	材質	処理	1	PBT	BLACK
製品コード			製 図	設 計	検 図
			G.Y.YOON	G.Y.YOON	D.H.CHO
			23.12.28	23.12.28	23.12.28
			承認	出 図	
			D.H.CHO	ENG	
			23.12.28	24.01.09	
			DEPT		
図 番	JDC3-633161-80		製品名	TF70-50P-0.5F(800)	
SCALE	4:1		製品コード	CL 6567-0003-8-800	
UNITS	mm			1/1	
	HRS HIROSE KOREA CO.,LTD.				