

Feb.1.2026 Copyright 2026 HIROSE ELECTRIC CO., LTD. All Rights Reserved.
 本製品を車載用途などの高い信頼性が求められる機器にご使用の場合は、弊社までお問合せ下さい。

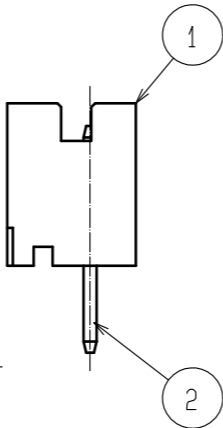

製品名	製品コード	極数	A	B	C
DF13- 2P-1.25DSA(05)	CL536-0101-9-05	2	1.25	3.15	4.15
DF13- 3P-1.25DSA(05)	CL536-0102-1-05	3	2.5	4.4	5.4
DF13- 4P-1.25DSA(05)	CL536-0103-4-05	4	3.75	5.65	6.65
DF13- 5P-1.25DSA(05)	CL536-0104-7-05	5	5	6.9	7.9
DF13- 6P-1.25DSA(05)	CL536-0105-0-05	6	6.25	8.15	9.15
DF13- 7P-1.25DSA(05)	CL536-0106-2-05	7	7.5	9.4	10.4
DF13- 8P-1.25DSA(05)	CL536-0107-5-05	8	8.75	10.65	11.65
DF13- 9P-1.25DSA(05)	CL536-0108-8-05	9	10	11.9	12.9
DF13-10P-1.25DSA(05)	CL536-0109-0-05	10	11.25	13.15	14.15
DF13-11P-1.25DSA(05)	CL536-0110-0-05	11	12.5	14.4	15.4
DF13-12P-1.25DSA(05)	CL536-0111-2-05	12	13.75	15.65	16.65
DF13-13P-1.25DSA(05)	CL536-0112-5-05	13	15	16.9	17.9
DF13-14P-1.25DSA(05)	CL536-0113-8-05	14	16.25	18.15	19.15
DF13-15P-1.25DSA(05)	CL536-0114-0-05	15	17.5	19.4	20.4

2 ソケットかん合図

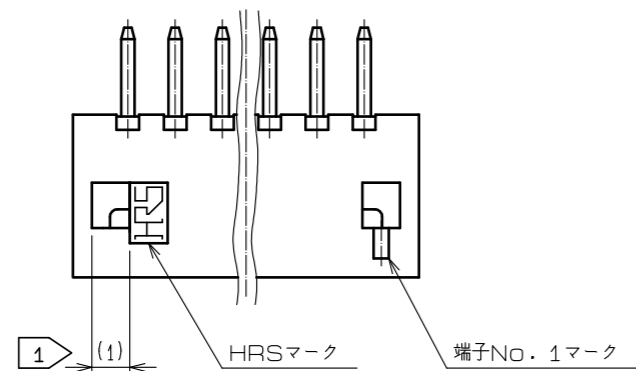
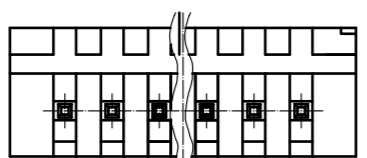
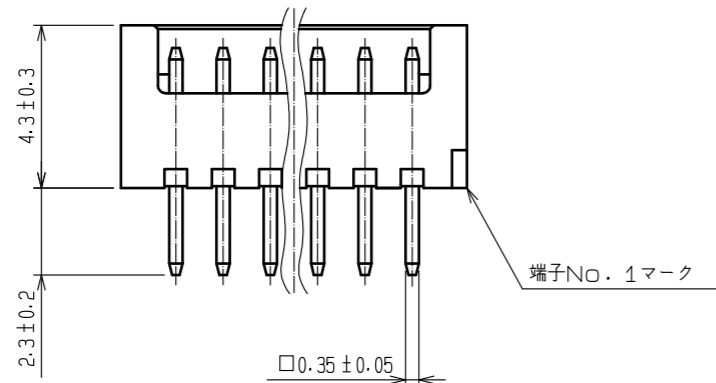
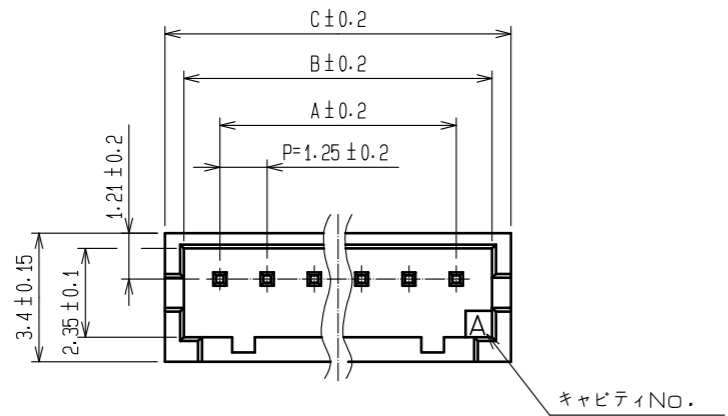
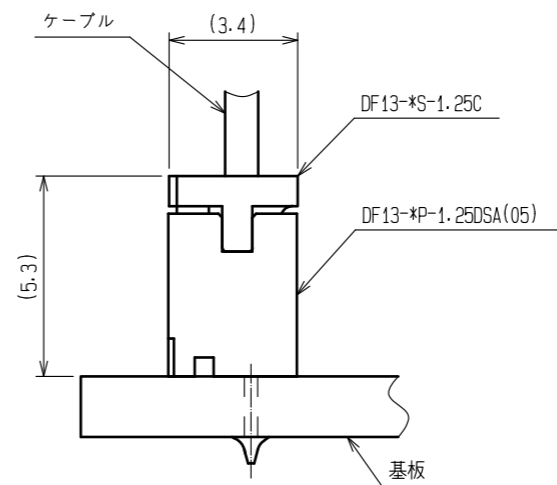

3 推奨基板パターン図
 (推奨基板厚 t=1.0mm)

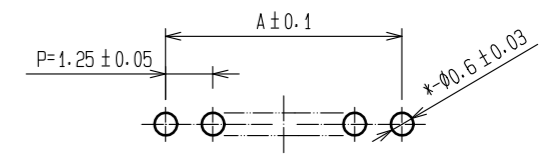

- 注 1 ロックは2~3極が中央に1つ、4極以上が図面通り2つ設ける。
 2 DF13-*S-1.25Cとのかん合高さは、5.3mm。
 3 推奨スルーホール径：φ0.6±0.03
 4 1パック100個梱包。

1	ポリアミド樹脂	BEIGE(NATURAL),UL94V-0	2	黄銅	表面:すずめっき 1μm min 下地:銅めっき 1μm min		
NO.	MATERIAL	FINISH, REMARKS	NO.	MATERIAL	FINISH, REMARKS		
UNITS	mm	SCALE	COUNT	DESCRIPTION OF REVISIONS	DESIGNED	CHECKED	DATE
		5:1	△	APPROVED :SJ. OKAMURA 20211217			
HIROSE ELECTRIC CO., LTD.				CHECKED :SZ. ONO 20211217	DRAWING NO. ADC-083673-05-00		
				DESIGNED :HT. SATO 20211217	PART NO. DF13-*P-1.25DSA(05)		
				DRAWN :SK. CHIBA 20211217	CODE NO. CL536-		
					1/1		