

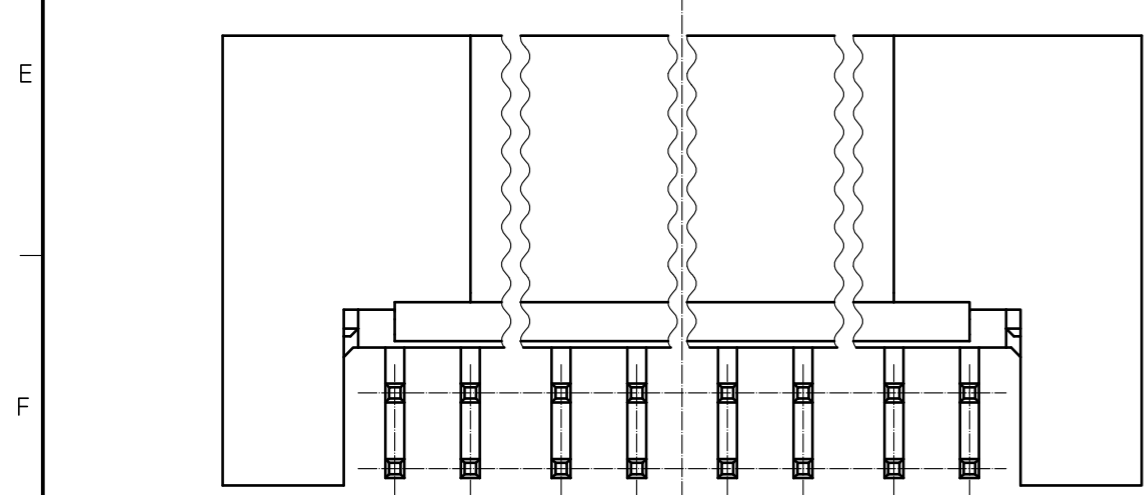

Sep.1.2024 Copyright 2024 HIROSE ELECTRIC CO., LTD. All Rights Reserved.
In case of consideration for using Automotive equipment / device which demand high reliability, kindly contact our sales window correspondents.

- Note 1. Number of connectors per a tray shall be in accordance with the list below.
 2. The dimension parenthesis are for reference.
 3. '*' and 'N' represent the number of contacts.
 4.  UL(File No. E52653),
 C-UL(File No. E52653) authorization article.

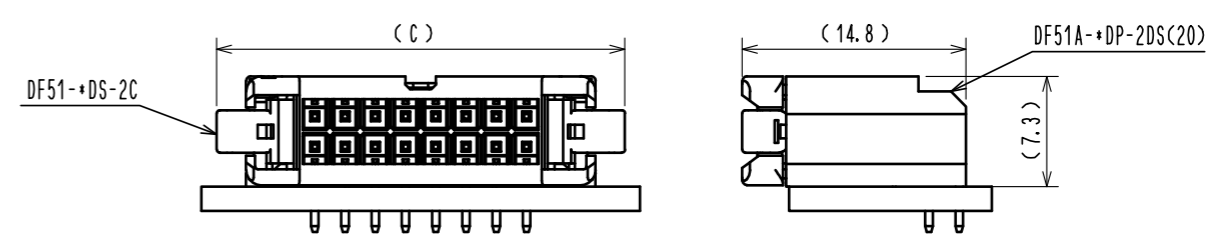
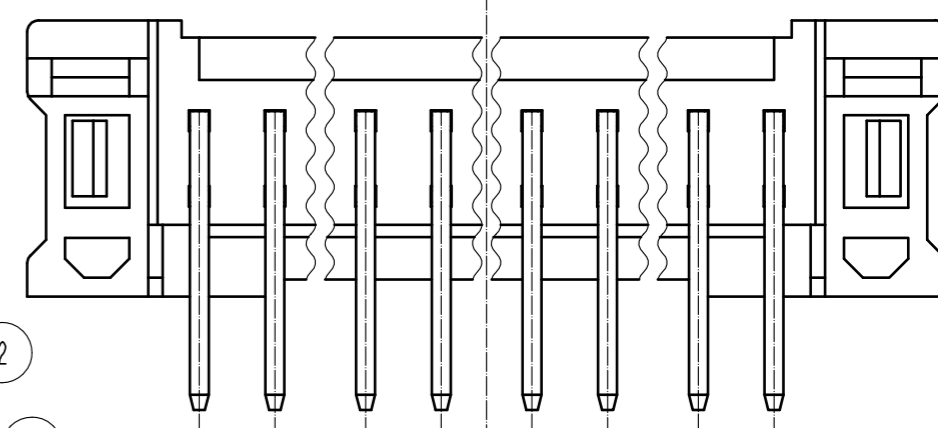
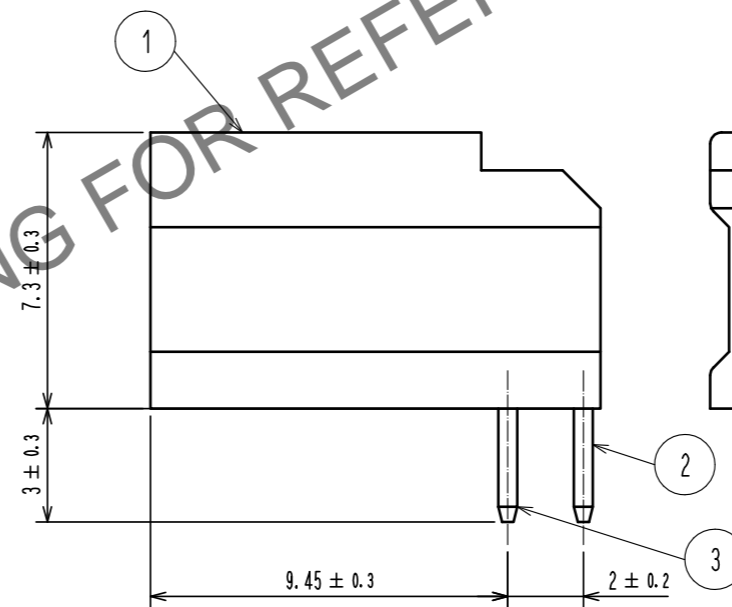
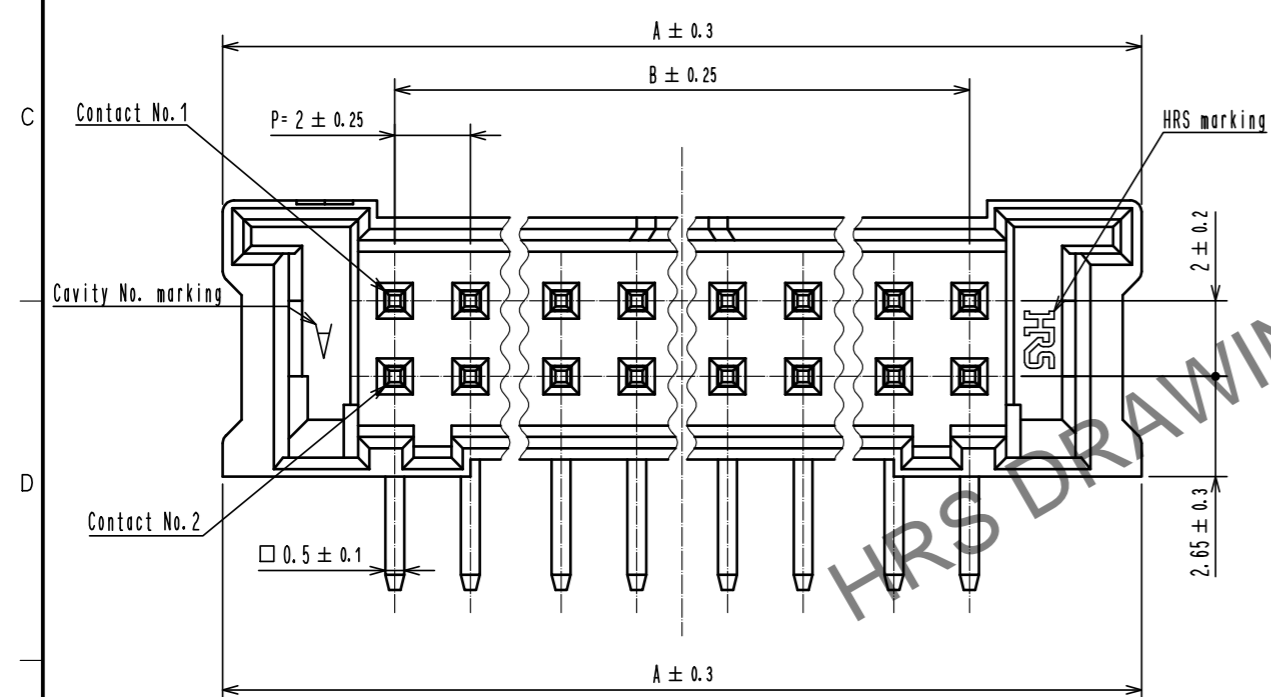
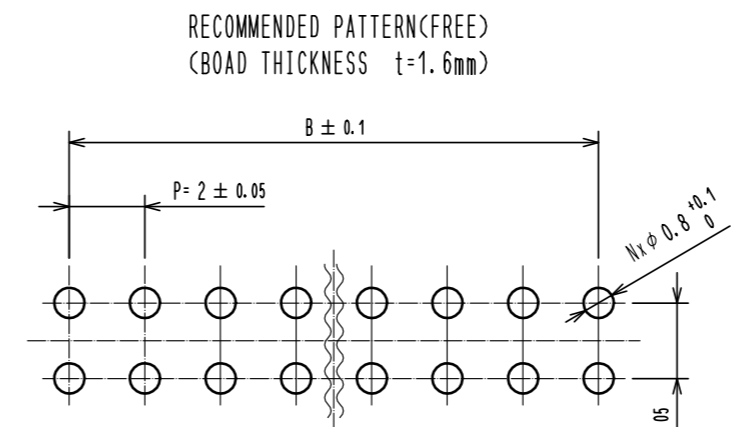
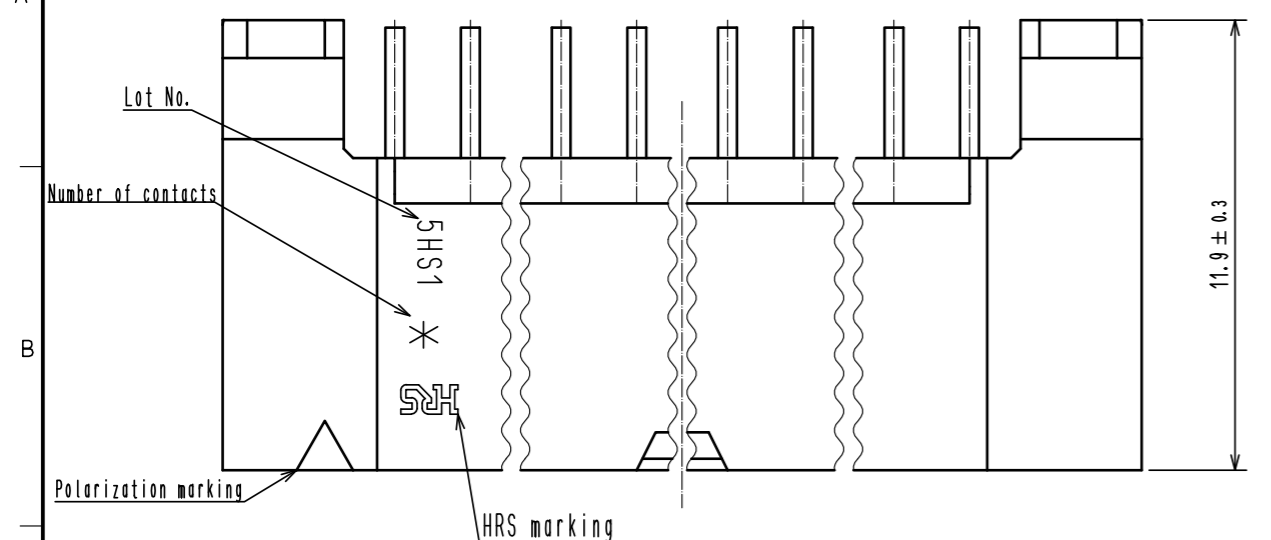

CODE No.	PART No.	N	A	B	C	NUMBER OF CONNECTORS
CL543-5059-0-20	DF51A-8DP-2DS(20)	8	15.1	6	19	171
CL543-5060-0-20	DF51A-10DP-2DS(20)	10	17.1	8	21	153
CL543-5061-0-20	DF51A-12DP-2DS(20)	12	19.1	10	23	135
CL543-5062-0-20	DF51A-14DP-2DS(20)	14	21.1	12	25	126
CL543-5063-0-20	DF51A-16DP-2DS(20)	16	23.1	14	27	108
CL543-5064-0-20	DF51A-18DP-2DS(20)	18	25.1	16	29	99
CL543-5065-0-20	DF51A-20DP-2DS(20)	20	27.1	18	31	90
CL543-5066-0-20	DF51A-22DP-2DS(20)	22	29.1	20	33	90
CL543-5067-0-20	DF51A-24DP-2DS(20)	24	31.1	22	35	81
CL543-5068-0-20	DF51A-26DP-2DS(20)	26	33.1	24	37	72
CL543-5069-0-20	DF51A-28DP-2DS(20)	28	35.1	26	39	72
CL543-5070-0-20	DF51A-30DP-2DS(20)	30	37.1	28	41	72



2	BRASS	SURFACE:Sn PLATING 1μm MIN UNDER PLATING:NICKEL PLATING 0.5μm MIN	4	PS	WHITE		
1	PBT	UL94V-0, BLACK	3	BRASS	SURFACE:Sn PLATING 1μm MIN UNDER PLATING:NICKEL PLATING 0.5μm MIN		
NO.	MATERIAL	FINISH, REMARKS	NO.	MATERIAL	FINISH, REMARKS		
UNITS mm		SCALE 5 : 1	COUNT 1	DESCRIPTION OF REVISIONS DIS-H-00004491	DESIGNED TS.MIYAKI	CHECKED SZ.ONO	DATE 20181211
HRS HIROSE ELECTRIC CO., LTD.		APPROVED : HS. OKAWA 20171011	DRAWING NO. EDC-379751-20-00				
		CHECKED : ST. WADA 20171011	PART NO. DF51A-*DP-2DS(20)				
		DESIGNED : TH. SATO 20171011	CODE NO. CL543				
		DRAWN : TH. SATO 20171011	1/2				

Sep.1.2024 Copyright 2024 HIROSE ELECTRIC CO., LTD. All Rights Reserved.
In case of consideration for using Automotive equipment / device which demand high reliability, kindly contact our sales window correspondents.

