

IT8 Series

High-Speed 56Gbps BGA Mezzanine Connectors



High Speed



BGA



Floating

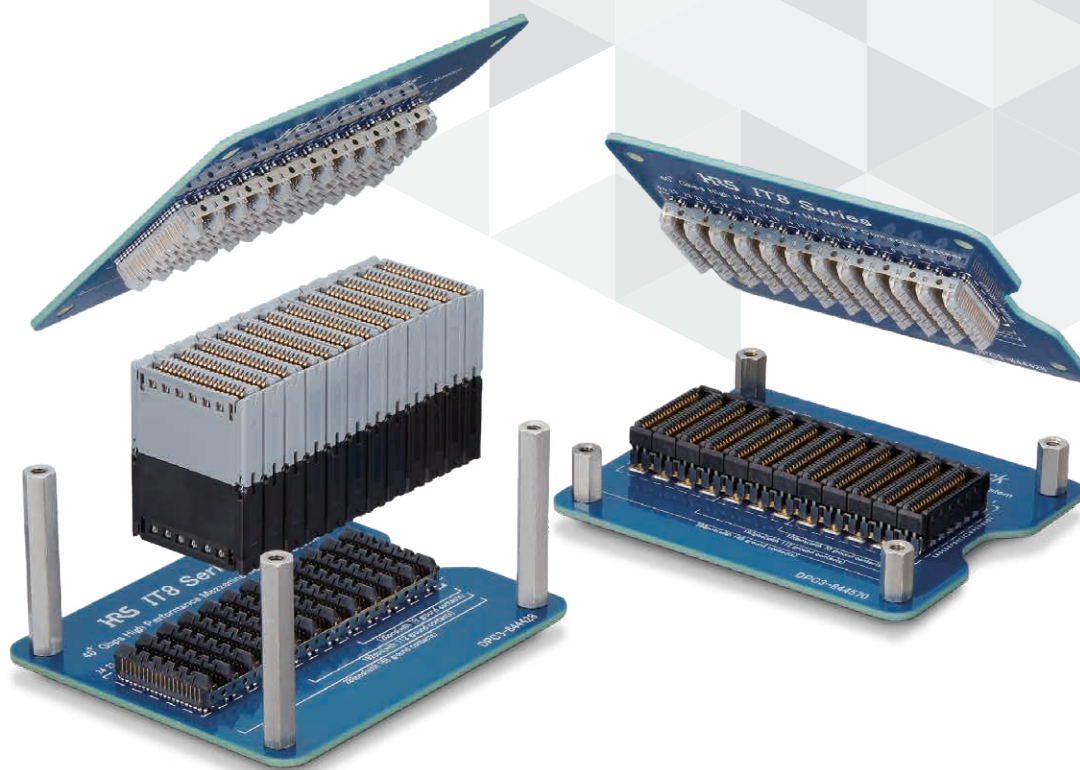

Mar. 1. 2025 Copyright 2025 HIROSE ELECTRIC CO., LTD. All Rights Reserved.



Overview

The IT8 mezzanine connector system is designed to deliver 56Gbps performance with the highest signal density in the market. It features a Quasi-Coaxial Structure and Polarity-Swap FEXT cancelling technology, making it the most reliable and flexible solution for high-speed system designs, both now and in the future.

Features

[Mechanical Features]

1. Stacking Heights

Two-piece Type: 10 to 13mm

Three-piece Type: 14 to 46mm

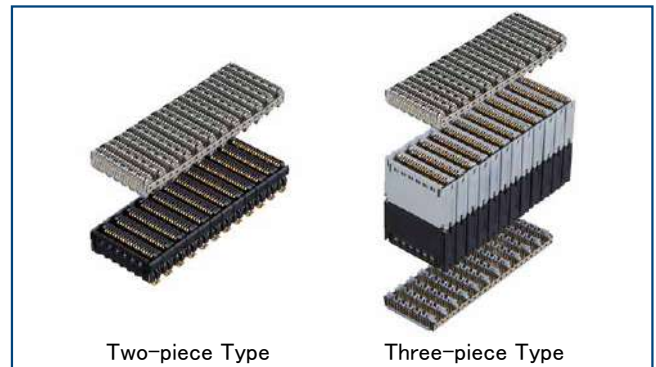

Two-piece Type

Three-piece Type

2. Available with 120, 192, or 288 signal contacts.

By combining signal pin counts, high signal pin counts can be achieved.



3. Multiple Mating Capability

Capable of handling up to ± 0.2 mm misalignment in the X and Y axes, allowing multiple IT8 connectors to be mounted on a single PCB.

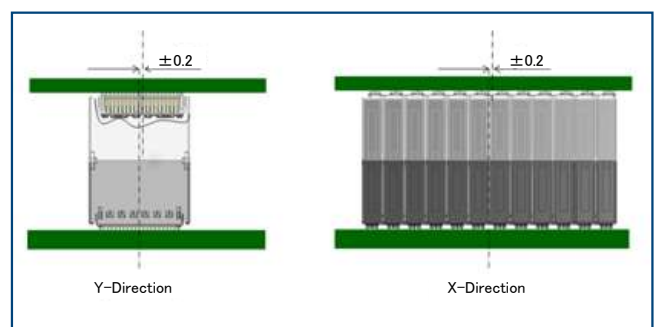

Y-Direction

X-Direction

4. Mating Alignment : +/- 1.5mm

The Two-piece and Three-piece designs allow for self-alignment during mating with up to $\pm 1.5\text{mm}$ tolerance in both the X and Y directions.

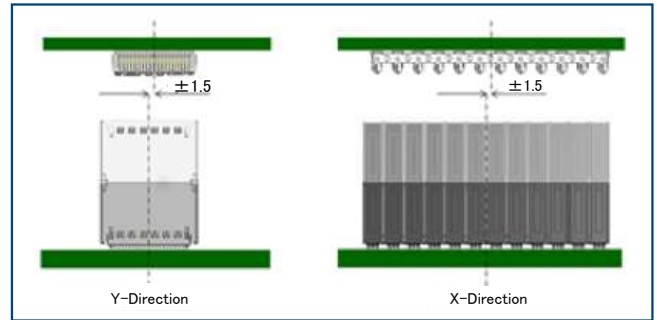

5. “Pin in Ball” BGA Attachment

Contact leads are surrounded by BGA solder balls, ensuring reliable solder joints and high yields in SMT processing.

This design also provides excellent reflow solderability and superior BGA coplanarity control.



6. Compatible with Double-sided and Inverted Reflow Soldering

Only the plug and receptacle sides undergo the reflow process, regardless of stacking height. The IT8 series' short connector height also makes it ideal for second reflow soldering.

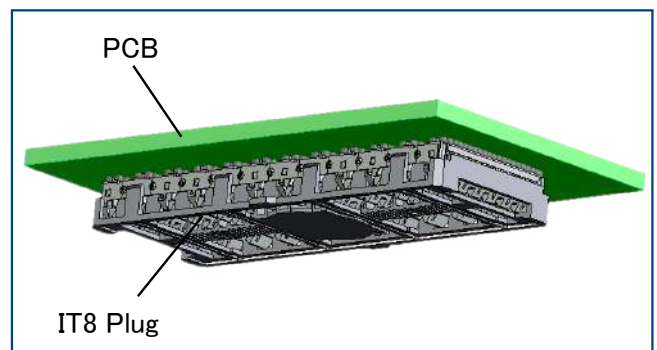

7. 1.0mm BGA Row Pitch for High Signal Density

[Signal Integrity Features] 8. SI Capability

Supports 56Gbps for the Three-piece design (14 to 46mm) and 28Gbps for the Two-piece design (10 to 13mm). The connector is suitable for both 100 Ω and 85 Ω systems with a 92 Ω impedance.

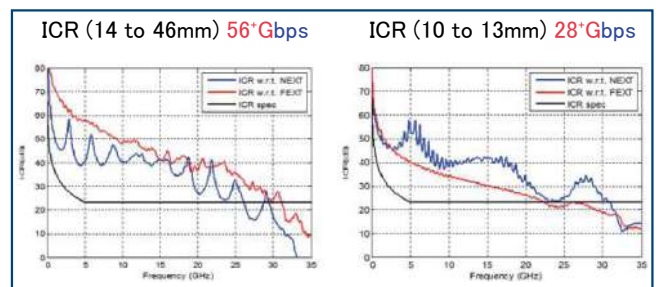

9. Unique Polarity-Swap FEXT Cancelling Technology

The interposer includes a polarity swap feature that reduces adjacent FEXT, enabling high density and high data rate transmission.

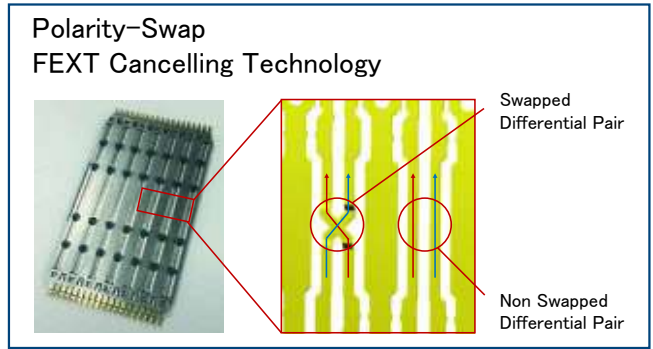

10. Quasi-Coaxial Design

The patented quasi-coaxial design in the IT8 Three-piece type prevents noise emission to other signals.

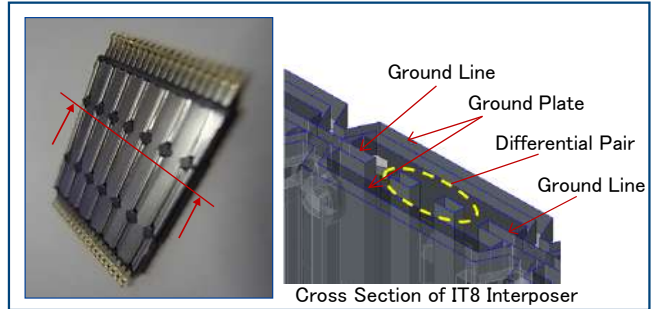

Stacking Height Variation

Two-piece Type

Stacking Height	Receptacle	Plug-D	Data Rate
10mm	IT8MB-BGA-10H	IT8D-BGA-0H	28Gbps
11mm		IT8D-BGA-1H	
12mm	IT8MB-BGA-12H	IT8D-BGA-0H	
13mm		IT8D-BGA-1H	



Stacking Height 10mm to 13mm
Two-piece Type

Three-piece Type

Stacking Height	Plug-M	Interposer	Plug-D	Data Rate
14mm	IT8M-BGA-0H	IT8LN-14H	IT8D-BGA-0H	56Gbps
15mm	IT8M-BGA-0H		IT8D-BGA-1H	
	IT8M-BGA-1H	IT8LN-14H-1	IT8D-BGA-0H	
16mm	IT8M-BGA-1H		IT8D-BGA-1H	
17mm	-	-	-	
18mm	IT8M-BGA-0H	IT8LN-18H	IT8D-BGA-0H	
19mm	IT8M-BGA-0H		IT8D-BGA-1H	
20mm	IT8M-BGA-1H		IT8D-BGA-1H	
21mm	-	-	-	
22mm	IT8M-BGA-0H	IT8-22H	IT8D-BGA-0H	
23mm	IT8M-BGA-0H		IT8D-BGA-1H	
24mm	IT8M-BGA-1H		IT8D-BGA-1H	
25mm	IT8M-BGA-0H	IT8-25H	IT8D-BGA-0H	
26mm	IT8M-BGA-0H		IT8D-BGA-1H	
27mm	IT8M-BGA-1H		IT8D-BGA-1H	
28mm	IT8M-BGA-0H	IT8-28H	IT8D-BGA-0H	
29mm	IT8M-BGA-0H		IT8D-BGA-1H	
30mm	IT8M-BGA-1H		IT8D-BGA-1H	
31mm	-	-	-	
32mm	IT8M-BGA-0H	IT8-32H	IT8D-BGA-0H	
33mm	IT8M-BGA-0H		IT8D-BGA-1H	
34mm	IT8M-BGA-1H		IT8D-BGA-1H	
35mm	IT8M-BGA-0H	IT8-35H	IT8D-BGA-0H	
36mm	IT8M-BGA-0H		IT8D-BGA-1H	
37mm	IT8M-BGA-1H		IT8D-BGA-1H	
38mm	IT8M-BGA-0H	IT8-38H	IT8D-BGA-0H	
39mm	IT8M-BGA-0H		IT8D-BGA-1H	
40mm	IT8M-BGA-1H		IT8D-BGA-1H	
41mm	IT8M-BGA-0H	IT8-41H	IT8D-BGA-0H	
42mm	IT8M-BGA-0H		IT8D-BGA-1H	
43mm	IT8M-BGA-1H		IT8D-BGA-1H	
44mm	IT8M-BGA-0H	IT8-44H	IT8D-BGA-0H	
45mm	IT8M-BGA-0H		IT8D-BGA-1H	
46mm	IT8M-BGA-1H		IT8D-BGA-1H	



Stacking Height 14mm to 46mm
Three-piece Type

Product Specifications

Rated	Rated Current	0.5A / Pin (Signal)
	Rated Voltage	50V AC
	Operation Temperature	-55 to +85°C
	Storage Temperature	-10 to +60°C
	Operating Humidity	For relative humidity, 90% Max (No dew condensation is permitted)

Items	Specifications	Conditions
Contact Resistance (Note1)	50mΩ Max. : 10 to 16mm 60mΩ Max. : 18 to 27mm 70mΩ Max. : 28 to 37mm 80mΩ Max. : 38 to 46mm	Measured at 100mA
Insulation Resistance	1,000MΩ Min.	Measured at 100V DC
Withstand Voltage	No flashover and insulation breakdown	150V AC for 1 min.
Mating Durability	Contact Resistance : 20mΩ Max. No damage, crack or loose part	100 times
Vibration Resistance	No electrical interruption of 1 μs or more. No damage, crack or loose part	Frequency : 50 to 2,000Hz/cycle ; Power spectrum density : 0.1G ² /Hz for 120 min in three directions
Cyclic Temperature and Humidity	Contact Resistance : 20mΩ Max. No damage, crack or loose part	25°C , 80% RH : 60 min dwell time, 30 min ramp time 65°C , 50% RH : 60 min dwell time under 24 cycles

Note1 : The value of contact resistance includes the bulk resistance.

Materials / Finish

Receptacle

Component	Material	Finish / Remarks
Housing	PPS	Black / UL94V-0
Blade	LCP	Black / UL94V-0
Contact	Copper Alloy	Contact Area : Gold (0.76 μ m Min.) over Nickel (1.27 μ m Min.) Other : Nickel (1.27 μ m Min.)
Ground Shield	Stainless Steel	-
Retention Peg	Copper Alloy	Gold (0.03 μ m Min.) over Nickel (1.0 μ m Min.)
Solder Ball	Tin (Pb-Free)	Sn(96.5)-Ag(3)-Cu(0.5)
Pick Up Tape	Heat Resistant Tape	Polyamide
Tray	HIPS	Black

Interposer

Component	Material	Finish / Remarks
Housing (Detachable Side)	PPS	Gray / UL94V-0
Housing (Mounting Side)	PPS	Black / UL94V-0
Guide Plate	Stainless Steel	-
Blade	LCP	Black / UL94V-0
Contact	Copper Alloy	Contact Area : Gold (0.76 μ m Min.) over Nickel (1.27 μ m Min.) Other : Nickel (1.27 μ m Min.)
Ground Shield	Stainless Steel	-
Tray	HIPS	Not shown in the customer drawing

Plug

Component	Material	Finish / Remarks
Ground Shield	Copper Alloy	Nickel (1.27 μ m Min.)
Housing	LCP	Black or Gray / UL94V-0
Contact	Copper Alloy	Contact Area : Gold (0.76 μ m Min.) over Nickel (1.27 μ m Min.) Other : Nickel (1.27 μ m Min.)
Solder Ball	Tin	Sn(96.5)-Ag(3)-Cu(0.5)
Pick Up Cap	PA-M	Black / UL94V-0
Tray	HIPS	-

Product Number Structure

Please utilize the below part number chart when selecting.

Plug Mounting Side

IT8 M - ### P - BGA - #H

① ② ③ ④ ⑤ ⑥

Plug Detachable Side

IT8 D - ### P - BGA - #H

① ② ③ ④ ⑤ ⑥

Interposer

IT8 ## - ### S - ##H - #

① ② ③ ④ ⑥ ⑦

Mounting Receptacle

IT8 MB - ### S - BGA - #H

① ② ③ ④ ⑤ ⑥

① Series Name	IT8
② Connector Type	IT8M-###P-BGA : Mounting Plug IT8D-###P-BGA : Detachable Plug IT8MB-###S-BGA : Mounting Receptacle IT8LN-###S-##H : Interposer 14H,18H IT8-###S-##H : Interposer 22-44H
③ Signal Contact No. of Pos.	120, 192, 288
④ Connector Gender	S : Female (Receptacle or Interposer) P : Male (Plug)
⑤ Design	BGA : Ball Grid Array
⑥ Stacking Height	Mounting Plug : 0, 1 Detachable Plug : 0, 1 Mounting Receptacle : 10, 12 Interposer : 14, 18, 22, 25, 28, 32, 35, 38, 41, 44
⑦ Mounting Plug Restrictions (IT8LN-###S-14H Only)	None : Mounting Plug : IT8M-###P-BGA-0H 1 : Mounting Plug : IT8M-###P-BGA-1H

Plug

Three Piece Type Mounting Side

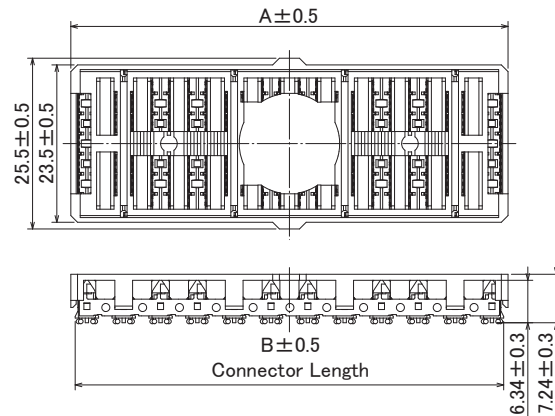
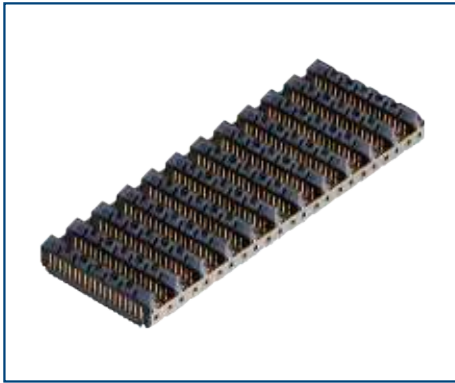

Note : Figure shows a product with a mounting cap.
Products are shipped with mounting caps attached.

Unit : mm

Part No.	HRS No.	Signal Contact No.	A	B
IT8M-120P-BGA-0H	CL0636-3001-9-00	120 (+70 Ground)	26.8	25.5
IT8M-120P-BGA-1H	CL0636-3100-0-00			
IT8M-192P-BGA-0H	CL0636-3002-1-00	192 (+112 Ground)	43.3	42
IT8M-192P-BGA-1H	CL0636-3101-3-00			
IT8M-288P-BGA-0H	CL0636-3003-4-00	288 (+168 Ground)	65.3	64
IT8M-288P-BGA-1H	CL0636-3102-6-00			

Two / Three Piece Type Detachable Side

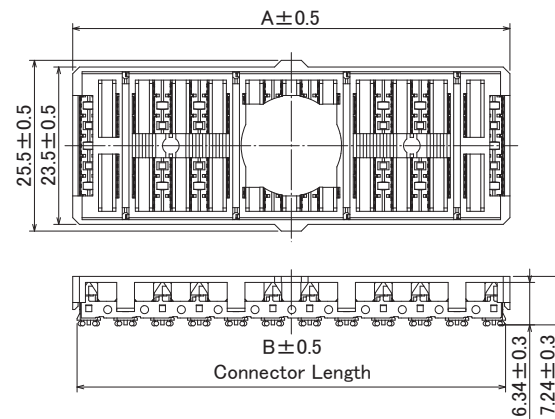

Note : Figure shows a product with a mounting cap.
Products are shipped with mounting caps attached.

Unit : mm

Part No.	HRS No.	Signal Contact No.	A	B
IT8D-120P-BGA-0H	CL0636-3200-5-00	120 (+70 Ground)	26.8	25.5
IT8D-120P-BGA-1H	CL0636-3300-0-00			
IT8D-192P-BGA-0H	CL0636-3201-8-00	192 (+112 Ground)	43.3	42
IT8D-192P-BGA-1H	CL0636-3301-2-00			
IT8D-288P-BGA-0H	CL0636-3202-0-00	288 (+168 Ground)	65.3	64
IT8D-288P-BGA-1H	CL0636-3302-5-00			

Receptacle

Two Piece Type

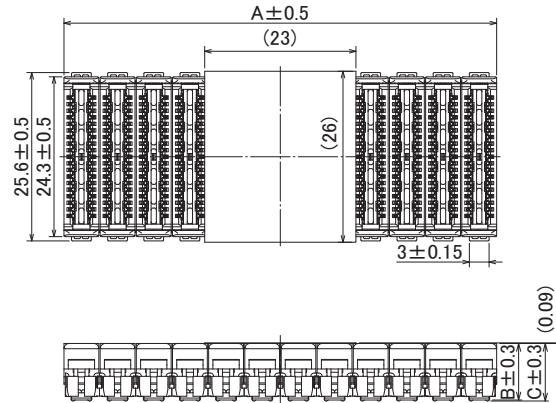
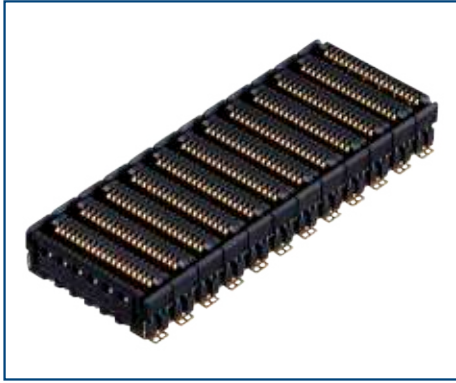

Note : Figure shows a product with a mounting tape.
Products are shipped with mounting tape attached.

Unit : mm

Part No.	HRS No.	Signal Contact No.	A	B	C
IT8MB-120S-BGA-10H	CL0636-3804-0-00	120 (+70 Ground)	27.3	8.6	8.75
IT8MB-192S-BGA-10H	CL0636-3805-0-00	192 (+112 Ground)	43.8	8.6	8.75
IT8MB-288S-BGA-10H	CL0636-3806-0-00	288 (+168 Ground)	65.8	8.6	8.75
IT8MB-120S-BGA-12H	CL0636-3906-0-00	120 (+70 Ground)	27.3	8.6	10.75
IT8MB-192S-BGA-12H	CL0636-3905-0-00	192 (+112 Ground)	43.8	8.6	10.75
IT8MB-288S-BGA-12H	CL0636-3907-0-00	288 (+168 Ground)	65.8	8.6	10.75

Interposer

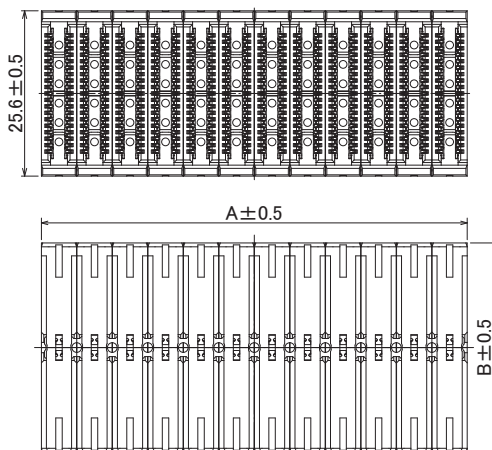

Unit : mm

Part No.	HRS No.	Signal Contact No.	A	B
IT8LN-120S-14H	Under Planning	120 (+70 Ground)	29.44	11.4
IT8LN-120S-14H-1	CL0636-3713-0-00			11.4
IT8LN-120S-18H	CL0636-3714-0-00			15.4
IT8-120S-22H	CL0636-3506-0-00		19.4	
IT8-120S-25H	CL0636-3503-0-00		22.4	
IT8-120S-28H	CL0636-3509-0-00		25.4	
IT8-120S-32H	CL0636-3512-0-00		29.4	
IT8-120S-35H	CL0636-3500-9-00		32.4	
IT8-120S-38H	CL0636-3517-0-00		35.4	
IT8-120S-41H	CL0636-3520-0-00		38.4	
IT8-120S-44H	CL0636-3523-0-00		41.4	

Unit : mm

Part No.	HRS No.	Signal Contact No.	A	B
IT8LN-192S-14H	Under Planning	192 (+112 Ground)	45.94	11.4
IT8LN-192S-14H-1	CL0636-3724-0-00			11.4
IT8LN-192S-18H	CL0636-3725-0-00			15.4
IT8-192S-22H	CL0636-3507-0-00		19.4	
IT8-192S-25H	CL0636-3504-0-00		22.4	
IT8-192S-28H	CL0636-3510-0-00		25.4	
IT8-192S-32H	CL0636-3513-0-00		29.4	
IT8-192S-35H	CL0636-3501-1-00		32.4	
IT8-192S-38H	CL0636-3518-0-00		35.4	
IT8-192S-41H	CL0636-3521-0-00		38.4	
IT8-192S-44H	CL0636-3524-0-00		41.4	

Unit : mm

Part No.	HRS No.	Signal Contact No.	A	B
IT8LN-288S-14H	Under Planning	288 (+168 Ground)	67.94	11.4
IT8LN-288S-14H-1	Under Planning			11.4
IT8LN-288S-18H	Under Planning			15.4
IT8-288S-22H	CL0636-3508-0-00		65.94	19.4
IT8-288S-25H	CL0636-3505-0-00			22.4
IT8-288S-28H	CL0636-3511-0-00			25.4
IT8-288S-32H	CL0636-3514-0-00			29.4
IT8-288S-35H	CL0636-3502-4-00			32.4
IT8-288S-38H	CL0636-3519-0-00			35.4
IT8-288S-41H	CL0636-3522-0-00			38.4
IT8-288S-44H	CL0636-3525-0-00			41.4

Pin Connection

Two Piece Type

For stacking height from 10 to 13mm, IT8 consists of 2 pieces:
Mounting Receptacle and Detachable Plug.

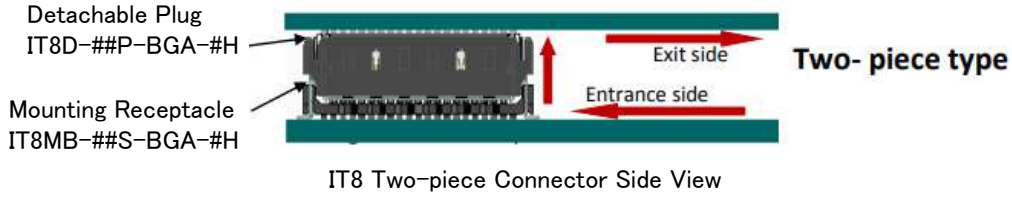

The pins of the mounting receptacles connect straight through to the pins of the detachable plug.
An example of connections of the two-piece IT8-120 pin connector shown below.

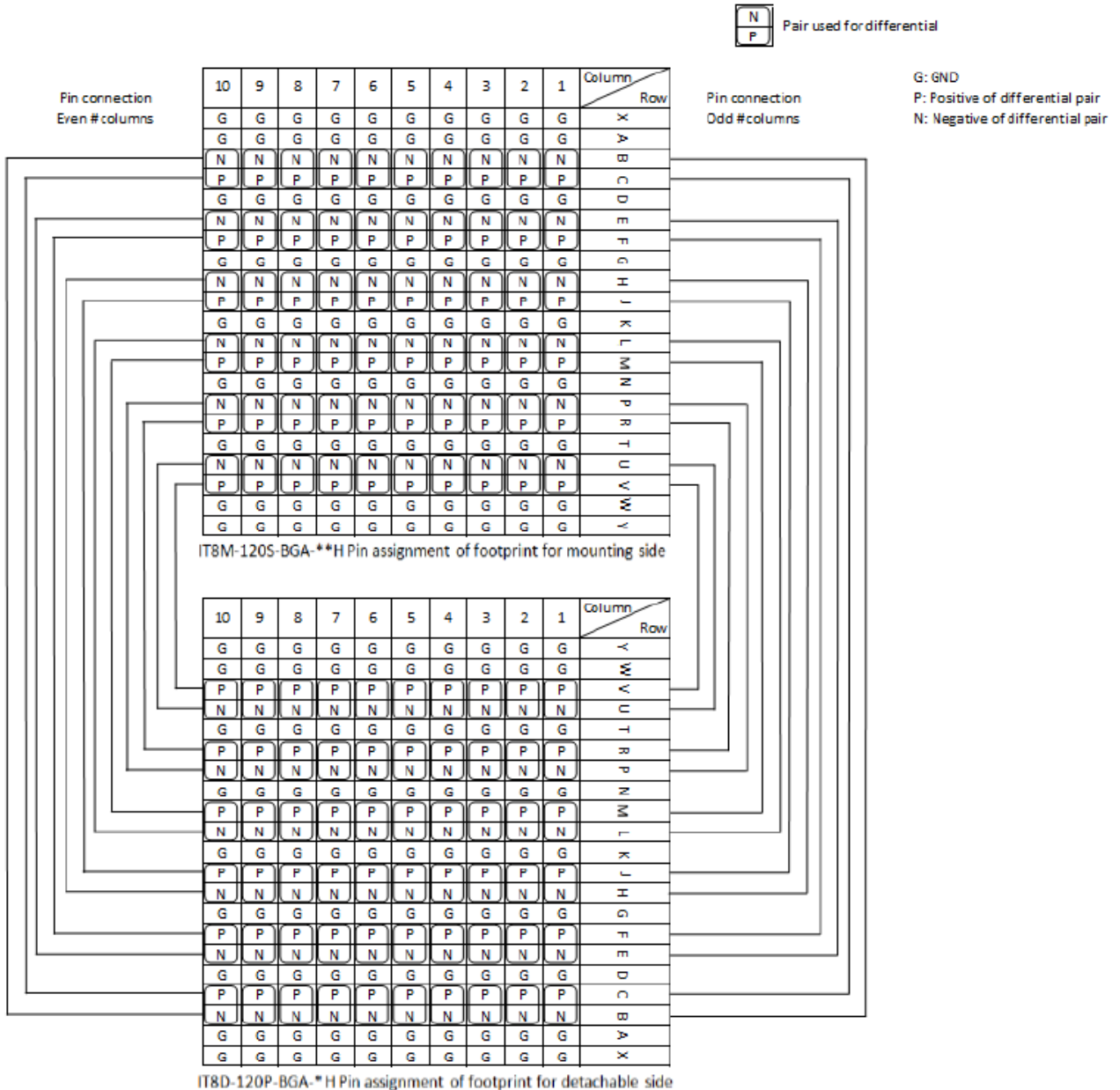

Three Piece Type

For stacking height of 14mm and up, IT8 consists of 3 pieces:
Mounting Receptacle, Interposer and Detachable Plug.

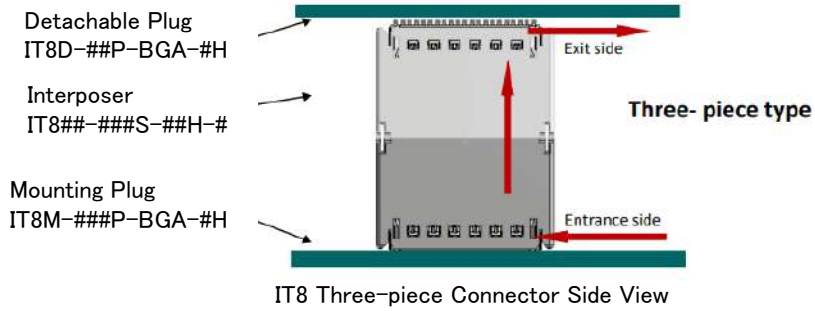

Below figure shows an example of connections of the three-piece IT8-120 pin connector. For the best use of FEXT cancellation technology, twisted pairs and non-twisted pairs are alternately in the same column and staggered between adjacent columns.

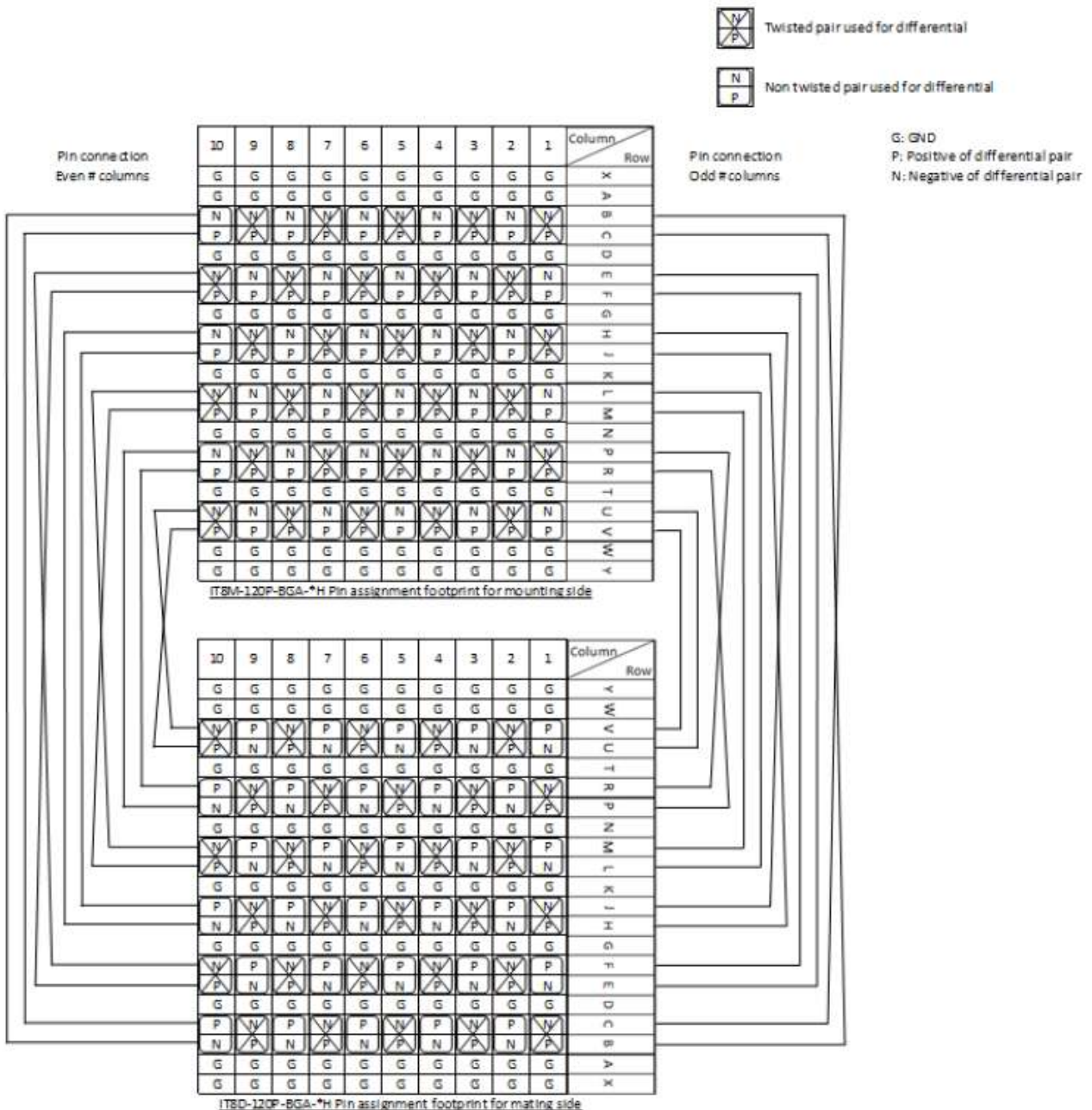

Recommended Land Pattern Dimension of PCB

Metal Mask Thickness : $t=0.127$ to 0.15mm

Plug (IT8M (or D) -###P-BGA-#H)

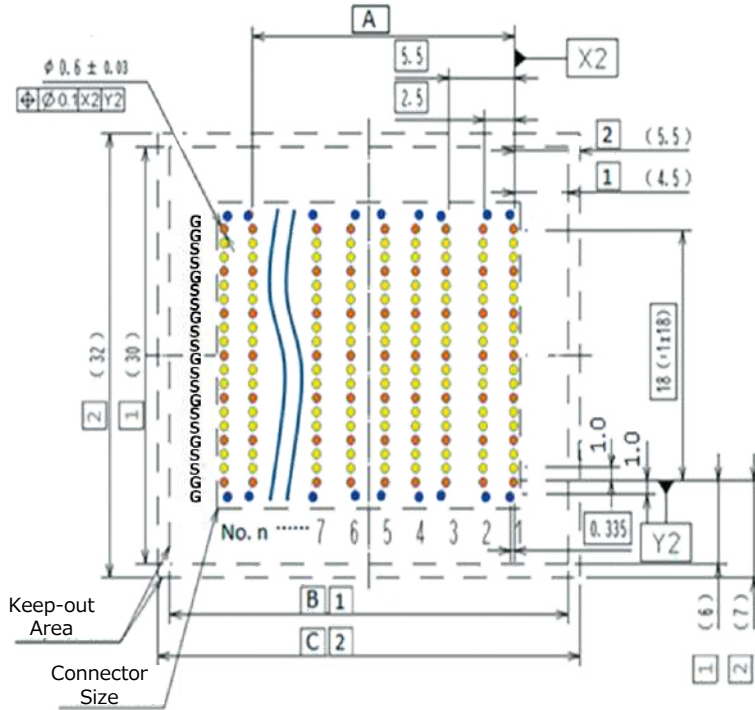

- 1 Minimum Clearance for All Devices
- 2 Minimum Clearance for Sensitive Devices

- Symbols
- Signal Pad
 - Ground Pad
 - Ground/ Retention Pin

Pin Assignment of IT8M-##P

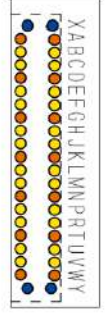

Pin Assignment of IT8D-##P

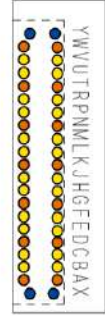

Dimension (mm)			
	120pos.	192pos.	288pos.
A	22	38.5	60.5
B	33.5	50	72
C	35.5	52	74

Receptacle (IT8MB-###S-BGA-##H)

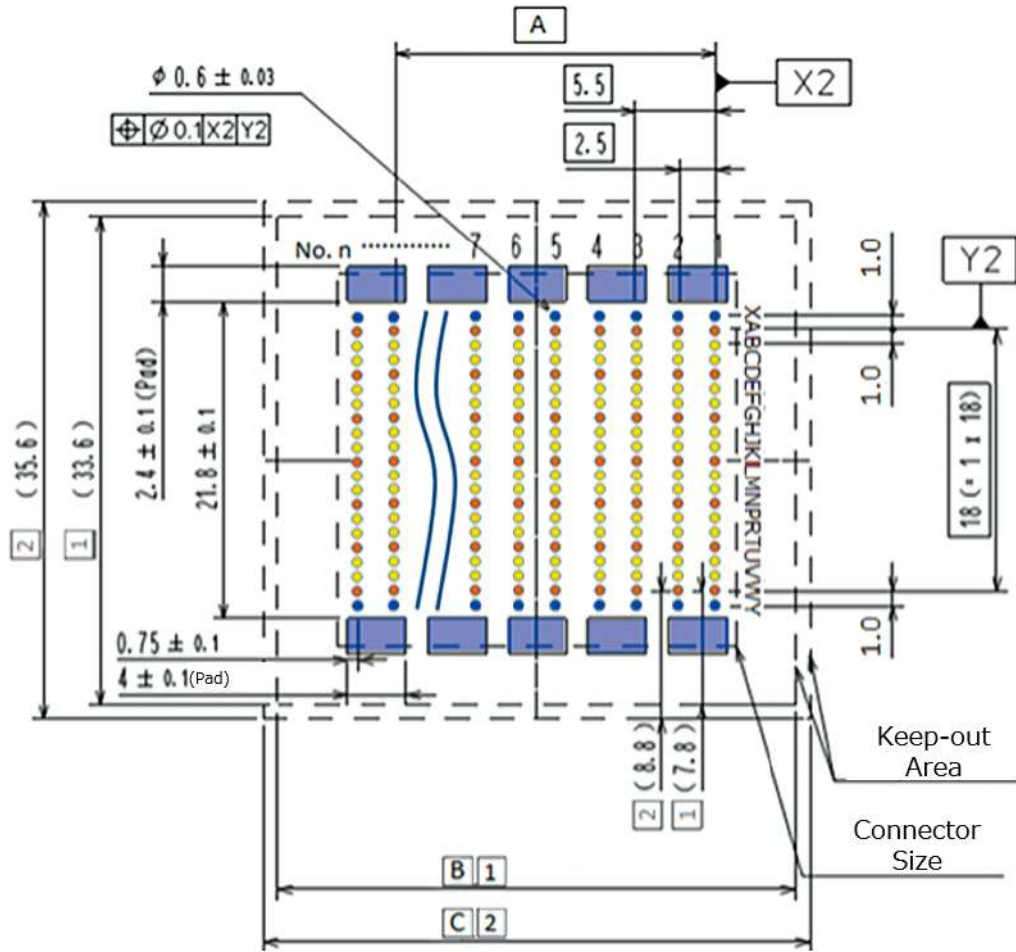

- 1 Minimum Clearance for All Devices
- 2 Minimum Clearance for Sensitive Devices

Symbols

- Signal Pad
- Ground Pad
- Ground/ Retention Pin
- Floating/Retention Pad

Dimension (mm)			
	120pos.	192pos.	288pos.
A	22	38.5	60.5
B	35.5	52	74
C	37.5	54	76

Spacers

Spacers are required to support the PWB's and protect the BGA solder joints.

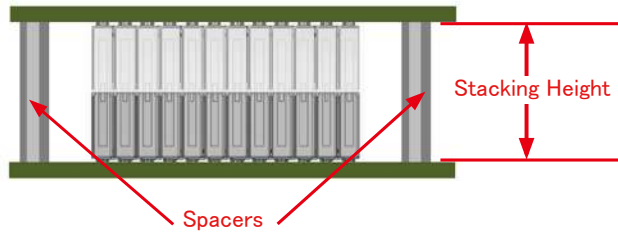

Suggested spacer style is shown below :



Spacer, male-male, M3 thread

The spacer heights must correspond to the stacking heights as shown below.

Stacking Height	Spacer Height
XXmm	XX +/-0.127mm

Note : XX is the value of stacking height.

Four spacers should be positioned in a rectangular or similar configuration, placed 10 to 50mm from the corners of the plugs or receptacles to minimize mechanical stress on the interconnections. For assemblies exposed to vibration, spacers should be placed to avoid resonance, and additional spacers may be needed.

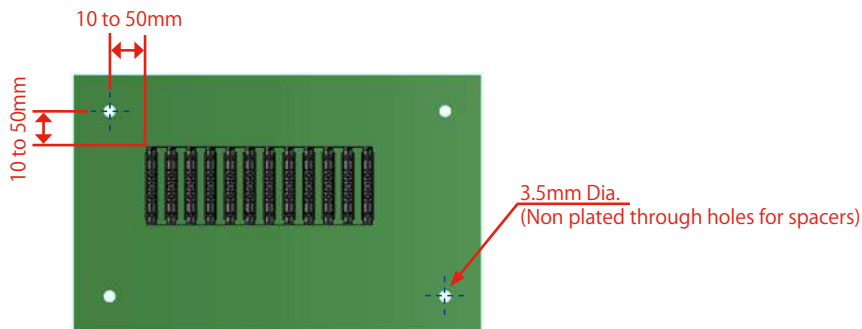

Interposer Installation

Mate black side of the interposer with the black mounting plug, otherwise signal pin-out will change and cause a system error.

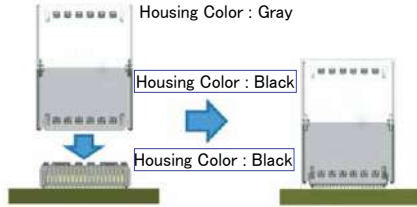

The interposer snaps onto the mounting plug as shown below.

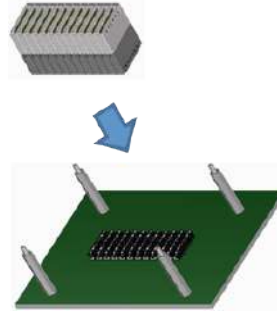

Detachable Plug Installation

Housing color of the detachable plug is gray, and the detachable plug must mate with the gray side of the interposer.

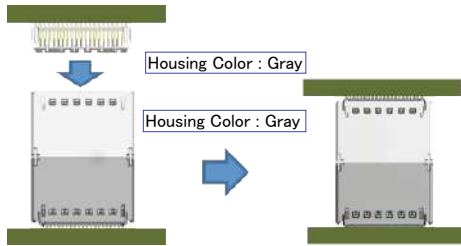

The spacers shall be installed prior to the operation. The detachable plug shall be aligned with the interposer and pressed on as shown below.

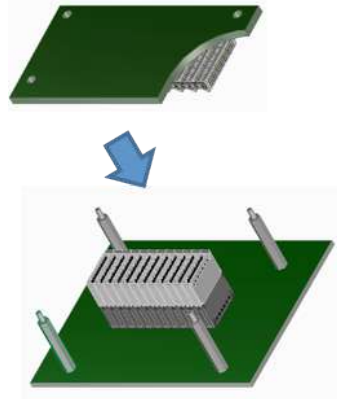

In mating operation, 0° for following angles are preferred. In case keeping 0° is difficult, following maximum angles shall not be exceeded during manual installation of the daughter card as shown below :

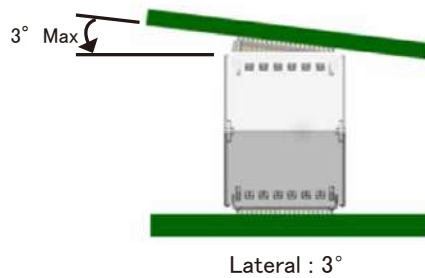
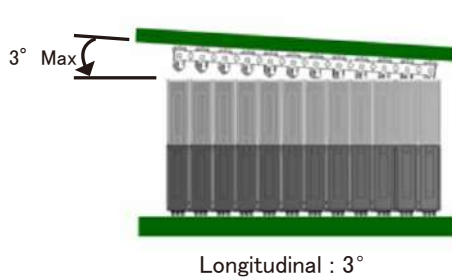

Interposer Removal

The removal of interposer shall be 5 times Max. For removal, hold the Interposer on the walls as shown below. Also, please grab the walls close to the gravity center of the interposer to prevent tilting of the interposer during removal operation.

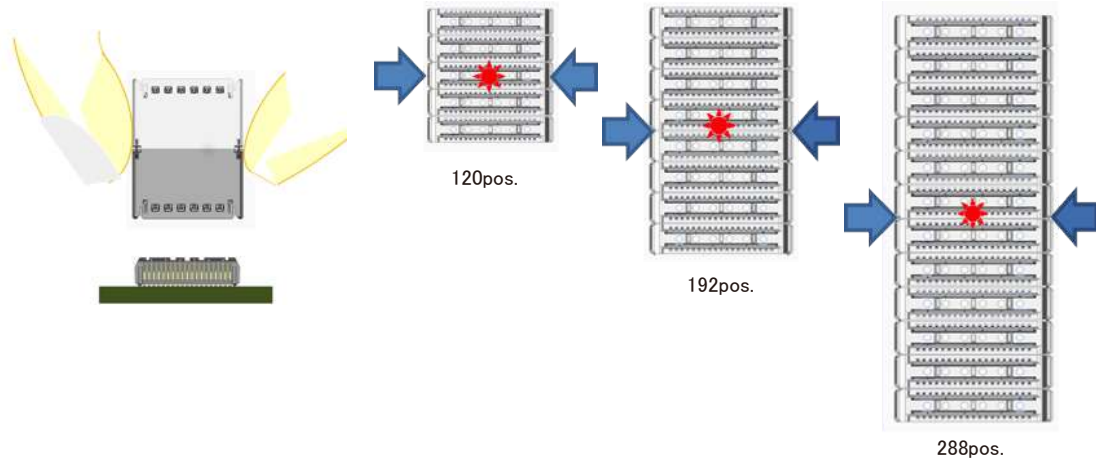

1) Hold the Interposer on the walls.

2) Gently rotate one side of the Interposer laterally 10° maximum.

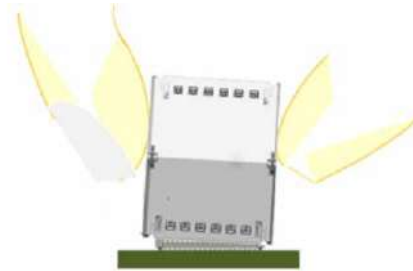

3) While gently rotating, pull up on other side of the Interposer.

4) The Interposer is removed, and the Mounting Plug is ready to accept another Interposer.

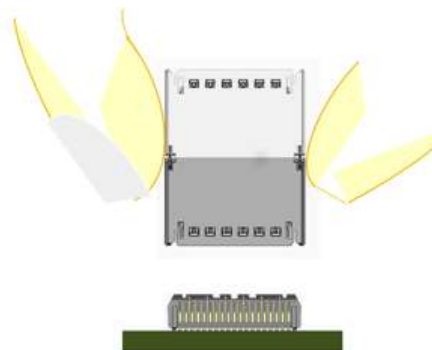
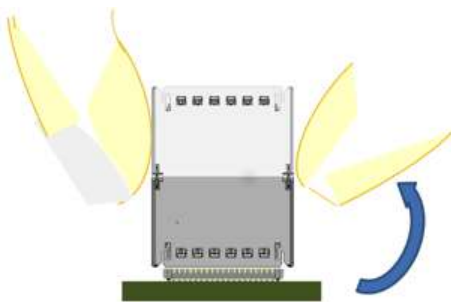

Mating Self Alignment

IT8 connector system have wide guiding taper for self alignment so that IT8 accept $\pm 1.5\text{mm}$ tolerance in the both X-direction and Y-direction

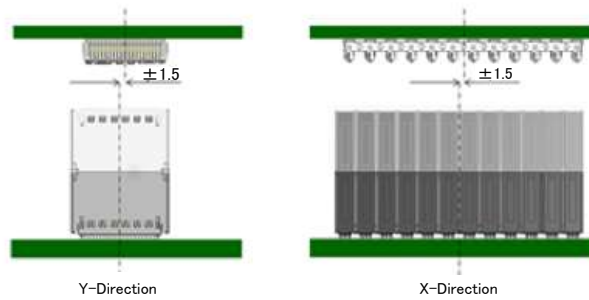

Mating Tolerance

Due to its unique floating structure design, the IT8 connector system can accept mating tolerances of up to $\pm 0.2\text{mm}$ tolerance in the both X-direction and Y-direction for multiple connector use.

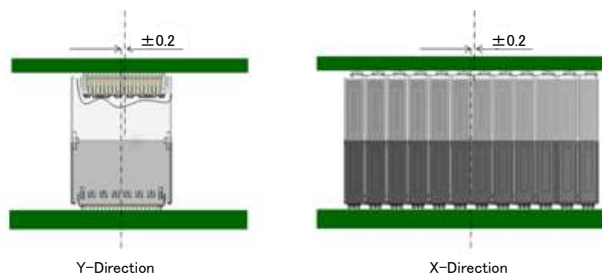

Assembly Reflow Soldering Profile

Different solder pastes have different thermal performance characteristics. Consult with paste manufacturer for optimum profile setting.

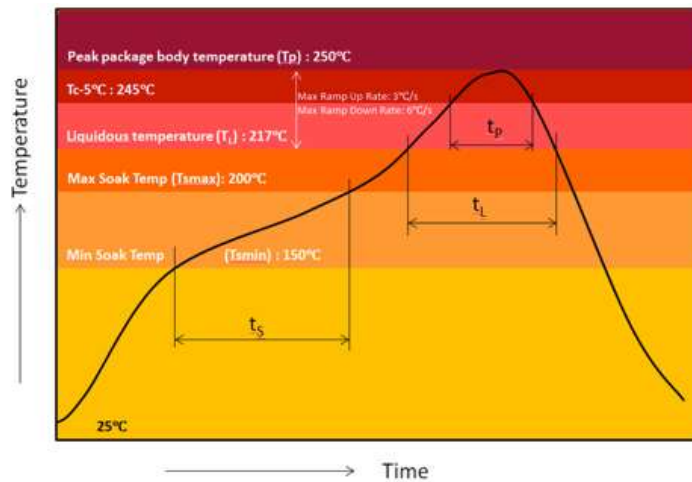

All temperatures refer to the center of the connector body, measured on the connector body surface that is facing up during assembly reflow.

Reflow profiles in this document are basically according to IPC/JEDEC J-STD-020D. 1 and are for preconditioning. Actual board assembly profiles should be developed based on specific process needs and board designs and should not exceed the parameters in the following Table.

Profile Feature	Condition	Note
Preheat/Soak Temperature Min (T_{min}) Temperature Max (T_{max}) Time (t_s) from (T_{min} to T_{max})	150°C 200°C 60 to 120 seconds	Soak requirements determined by board design, oven capability, and paste activation requirements. Caution- "oversoaking" may exhaust flux and affect soldering.
Ramp-up rate (T_L to T_p)	3°C /second Max.	Other components may limit ramp rate to 2°C /sec.
Liquidous temperature (T_L) Time (t_L) maintained above T_L	217°C 60 to 150 seconds	Shorter t_L may require higher peak temperature.
Peak package body temperature (T_p)	250°C Max.	Cooler peak temperatures may require longer t_L . For users T_p must not exceed the Classification temp (T_c) of 250°C .
Time (t_p)* within 5°C of the specified classification temperature (T_c)	30 seconds Max.	
Ramp-down rate (T_p to T_L)	6°C /second Max.	
Package Body Exposure Limit at Maximum Temperature	5 seconds	Adjust profile if maximum exposure limits approached or exceeded.

Packaging Information

Please order per box with its Minimum Order Quantity (MOQ) of connectors contained.
The number for each configuration is shown below.

(Receptacle) IT8MB-###S-BGA-##H (Plug) IT8M (or D) -###P-BGA-#H

Part No.	Quantity per Tray	Quantity per Box (3 trays + 1 rid) (Note1)
IT8#-120P (or S) -BGA-##H	36pcs	108pcs
IT8#-192P (or S) -BGA-##H	24pcs	72pcs
IT8#-288P (or S) -BGA-##H	16pcs	48pcs

Note1 : The lid is an empty Tray or a specialized lid.

(Interposer) IT8##-###S-##H-#

No. of Contacts	Quantity per Tray
120pos.	36pcs
192pos.	24pcs
288pos.	16pcs

No. of Contacts	Quantity per Box (28 to 44H type) (1 tray + 1 rid) (Note2)	Quantity per Box (22 to 25H type) (2 trays + 1 rid) (Note2)	Quantity per Box (14 to 18H type) (2 trays + 1 rid) (Note2)
120pos.	36pcs	72pcs	56pcs
192pos.	24pcs	48pcs	40pcs
288pos.	16pcs	32pcs	32pcs

Note2 : The lid is a specialized lid.

Final Appearance of Packaging

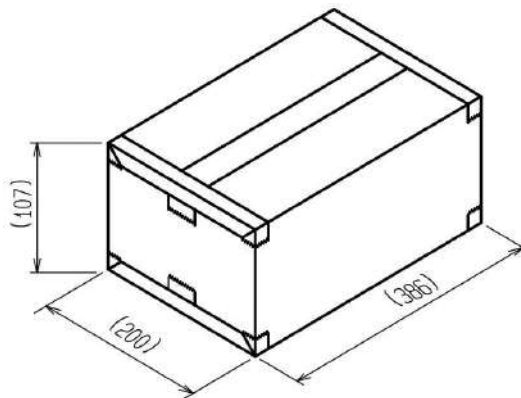

Tray Dimensions

Receptacle

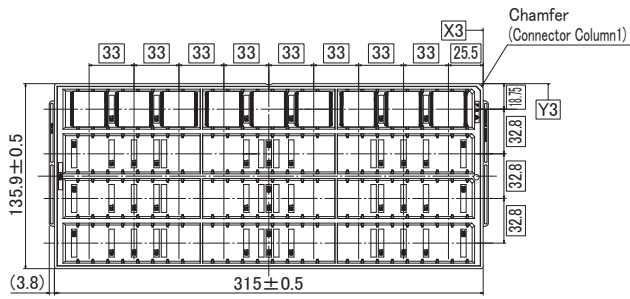

IT8MB-120S-BGA-##H

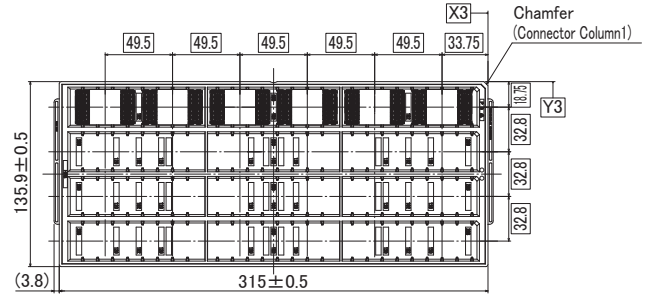

IT8MB-192S-BGA-##H

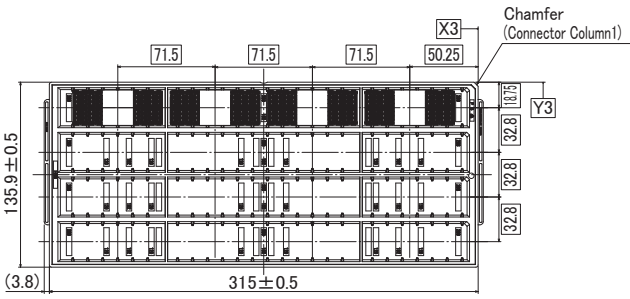

IT8MB-288S-BGA-##H

Plug

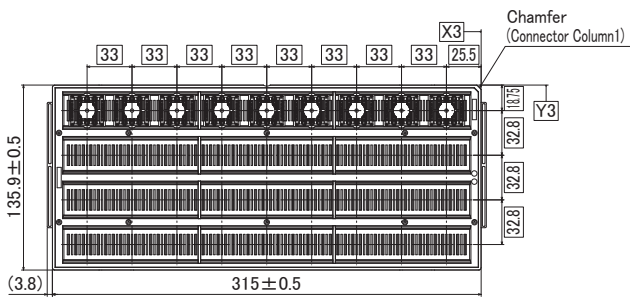

IT8M (or D) -120P-BGA-##H

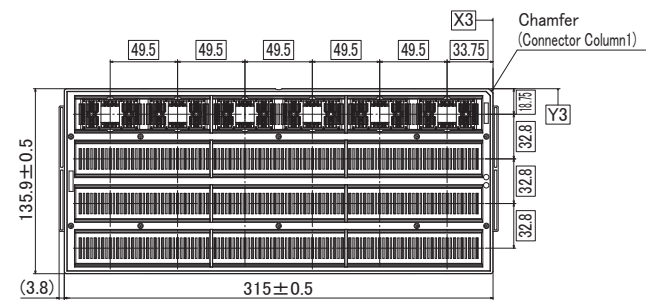

IT8M (or D) -192P-BGA-##H

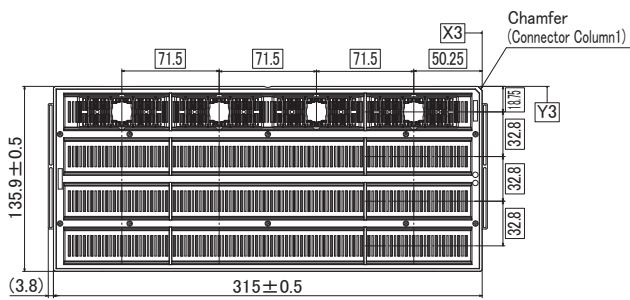

IT8M (or D) -288P-BGA-##H

Mar. 1. 2025 Copyright 2025 HIROSE ELECTRIC CO., LTD. All Rights Reserved.

Guideline

Please refer to the materials listed below when handling this product.

Assembly Guideline : ETAD-F0812-00

Design Guideline : ETAD-F0768-00

While Taking into Consideration

Specifications mentioned in this catalog are reference values.

When considering to order or use this product, please review the Drawing and Product Specifications sheets.

Use an appropriate cable when using the connector in combination with cables.

If considering usage of a non- specified cable, please contact your sales representative.

If assembly process is done by jigs & tools which are not identified by Hirose, the warranty of the product may be affected.

If considering usage for below mentioned applications, please contact your sales representative.

In cases where the application will demand a high level of reliability, such as automotive, medical instruments, public infrastructure, aerospace/ defense etc. Hirose must review before assurance of reliability can be given.