

1. Scope

This document specifies the cable assembly procedures of crimping the crimp contact to the applicable cables (26 to 34AWG) and inserting the contact to the crimp socket for DF57 Series.

2. Part Number

Part No.	Description
DF57-****SCF(A)(##)	Crimp contact
DF57(A)H-*S-1.2C(##)	Crimp socket

*: Number of position
 (##): Peculiar specification number

3. Cable Assembly Procedure

3.1. Cable Stripping

Follow the Crimping Quality Standard (ETAD-H0404-00), and strip the cable jacket. Make sure that there is no damage on the center conductor of the cable.

3.2. Crimping Process

Crimp the contact by using the applicator (AP105-DF57-****S(A)). Confirm that the crimp height and configuration meet the crimp condition and Crimping Quality Standard (ETAD-H0404-00).

3.3. Crimped Contact Insertion to Crimp Socket

Hold the cable of crimped contact and insert to each contact cavity of the crimp socket. (Insertion direction is as shown below.)

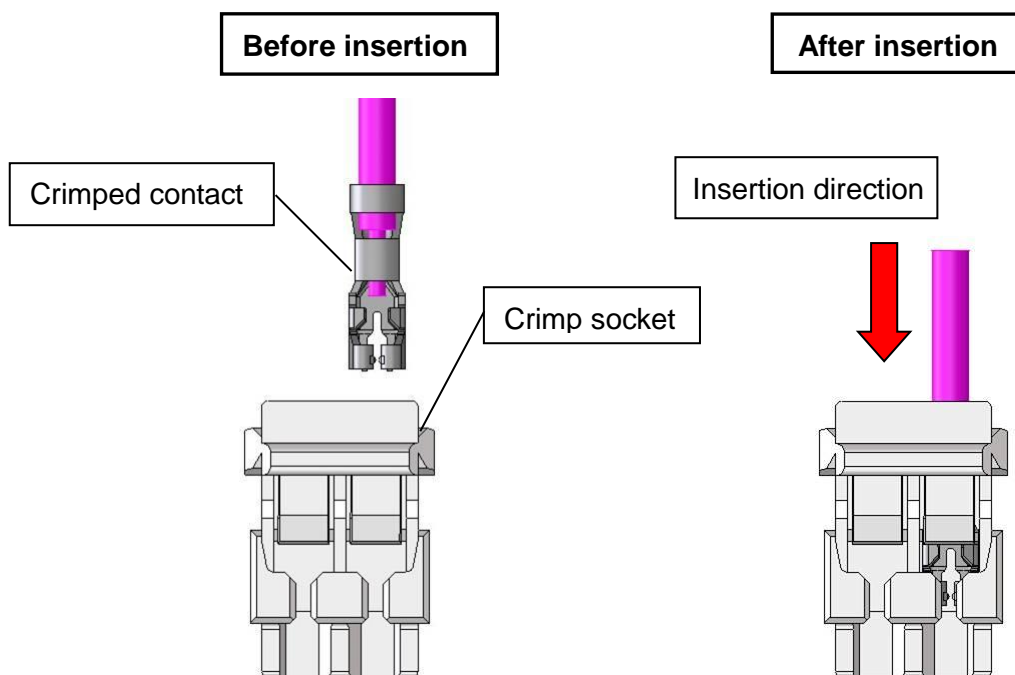

COUNT	DESCRIPTION OF REVISIONS	DESIGNED	CHECKED	DATE	
△ 2	DIS-H-00017315	HK.HAYASHI	SZ.ONO	20230224	
TITLE			HIROSE ELECTRIC CO., LTD.		
DF57 Series Cable Assembly Procedure					
APPROVED	TS.SAKATA	20100318			
CHECKED	TS.FUKUSHIMA	20100318			
DESIGNED	TS.KUMAZAWA	20100318	WRITTEN	TS.KUMAZAWA	20100318
TECHICAL SPECIFICATION			ETAD-H0421-00	△ 1 / 4	

-Do not insert the crimped contact (DF57-****SCF(A)(##)) at an angle to the socket in order to maintain performance reliability.

Straight insertion (Correct)

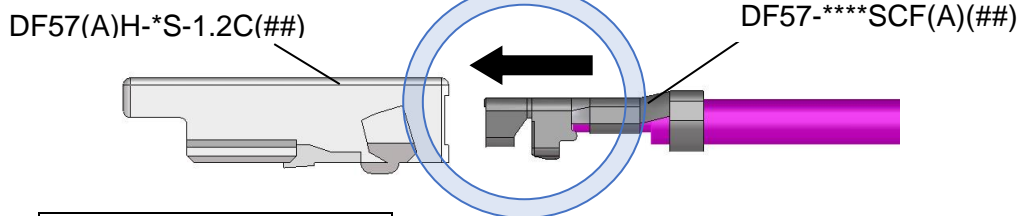

Angled insertion (Incorrect)

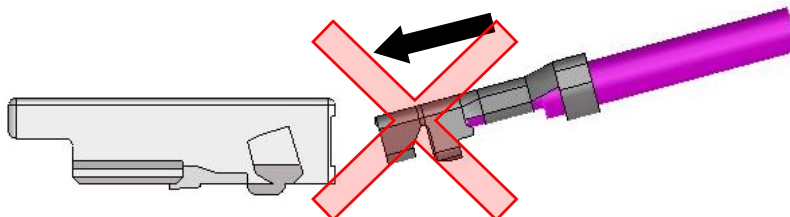

Scoop insertion (Incorrect)

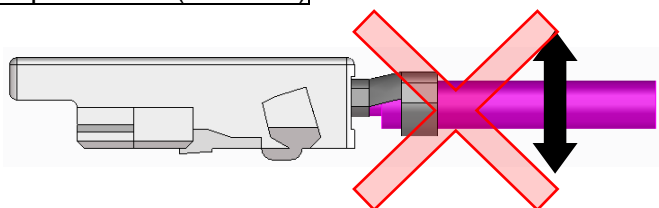

• After crimped contact insertion, please don't twist a cable excessively.

Twisted (Incorrect)

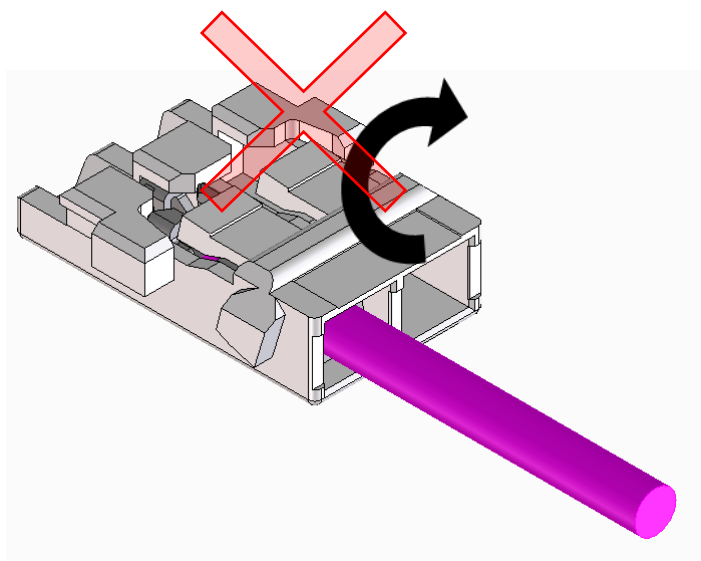

3 -Do not hold the housing lance while inserting the crimped contact in order to prevent the lance deformation or damaged.

Holding direction (Correct)

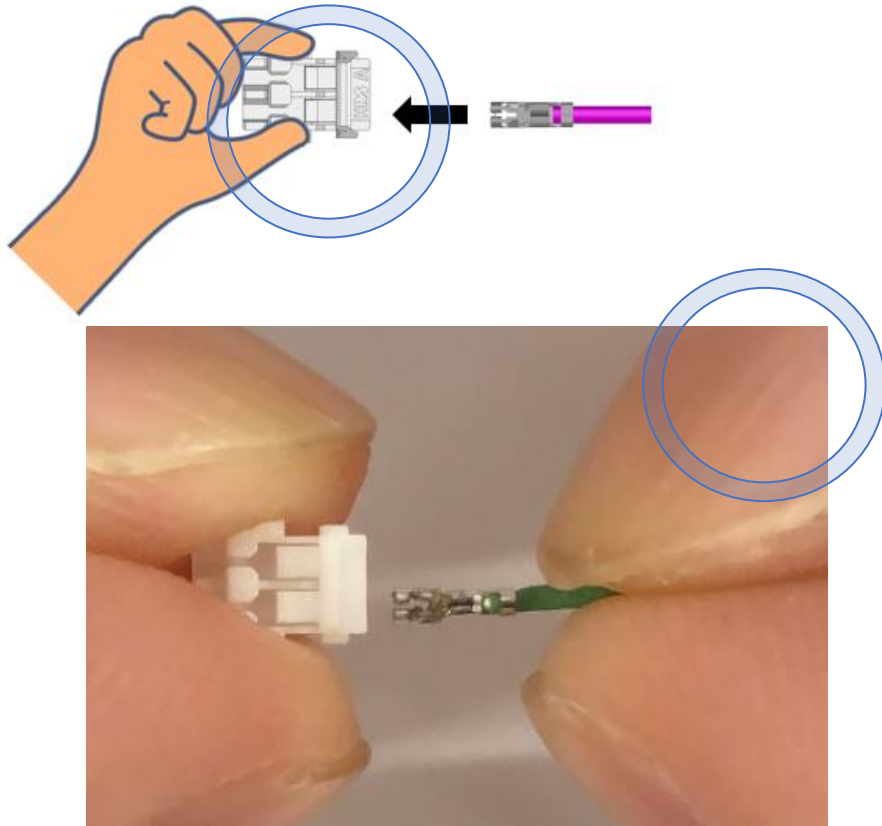

Holding direction (Incorrect)

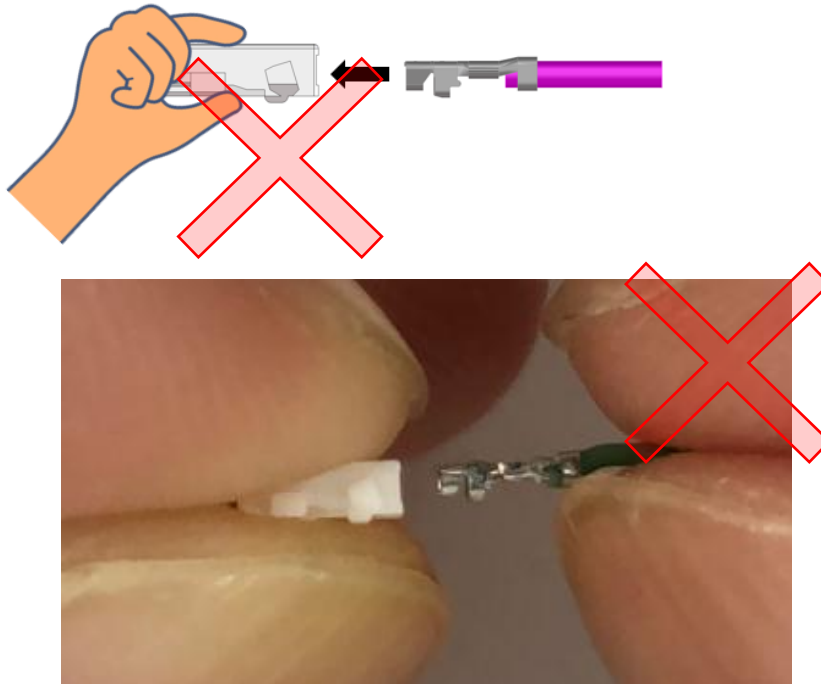

3 Note: In the event of using cables types other than HRS recommended type, that has special characteristics such as stiffness/hardness in conductor wire like Copper-Tin alloy (CuSn0.3) or in insulator type like Ethylene tetrafluoroethylene (ETFE) to have high corrosion resistance and mechanical strength; then we recommend you to contact/consult HRS representative directly for checking its compatibility.

Confirmation of instead contact conditions

Make sure that the contact lance is caught by the housing lance of the crimp socket.

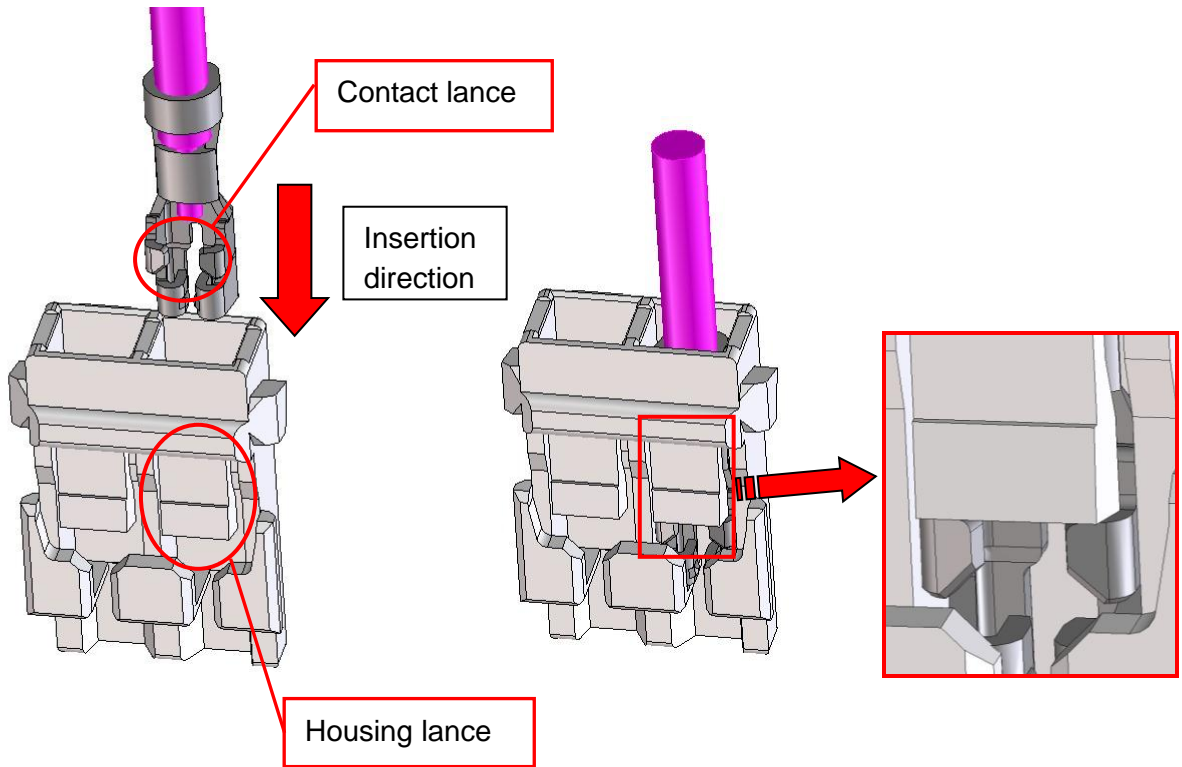

NOTE: Repairing the crimp contact

For removing the inserted crimp socket, lift up the mold lance by using DF-C-PO(B) or a pointed needle and such, and pull out the cable simultaneously. This could lower the lance strength, therefore, do not reuse the crimp socket and replace it to a new one.

