

Oct.1.2024 Copyright 2024 HIROSE ELECTRIC CO., LTD. All Rights Reserved.
 In case of consideration for using Automotive equipment / device which demand high reliability, kindly contact our sales window correspondents.

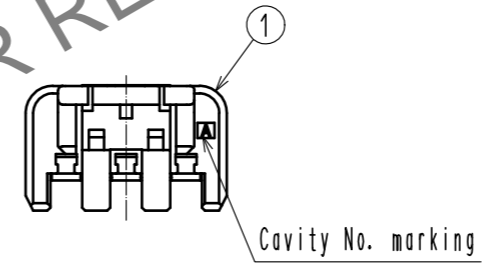

HRS DRAWING FOR REFERENCE

- Note. 1. 100 pieces per pack.
 2. The dimensions in parenthesis are for reference.
 3. UL (File No. E52653)
 C-UL (File No. E52653)
 TÜV (Certificate No. R50372836)
 authorization article.

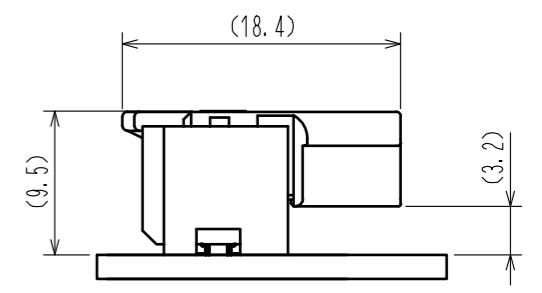
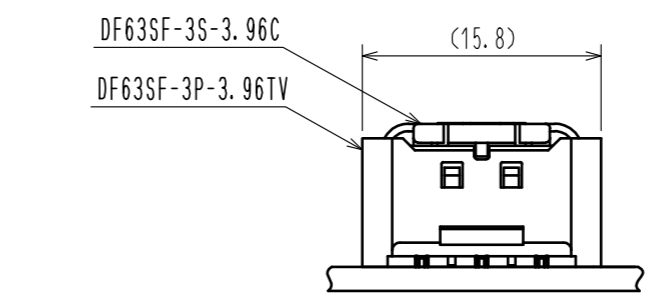
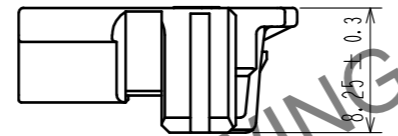
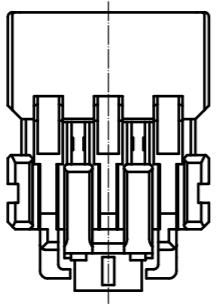
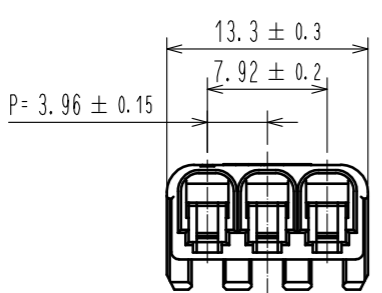
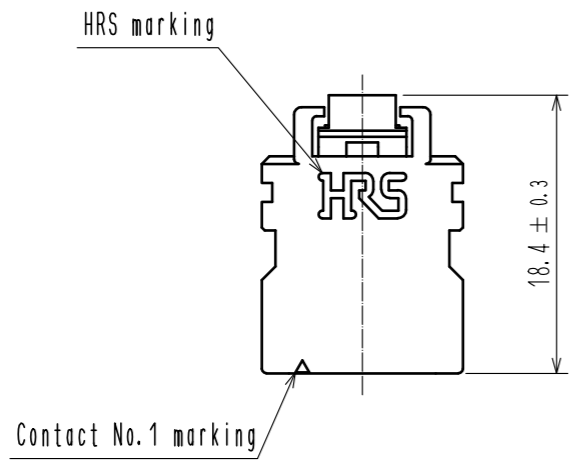

NO.	MATERIAL	FINISH . REMARKS	NO.	MATERIAL	FINISH . REMARKS		
1	PBT			UL94V-0(BLACK)			
UNITS		SCALE	COUNT	DESCRIPTION OF REVISIONS	DESIGNED	CHECKED	DATE
mm		2 : 1	1	DIS-H-00006191	TS.MIYAKI	SZ.ONO	20200803
HRS HIROSE ELECTRIC CO., LTD.		APPROVED : HS. OKAWA	20161125	DRAWING NO. EDC-367035-00-01			
		CHECKED : YN. TAKASHITA	20161125	PART NO. DF63SF-3S-3.96C			
		DESIGNED : SANGMUK. LIM	20161125	CODE NO. CL680-0702-0-00			
		DRAWN : SANGMUK. LIM	20161125				