

Apr.1.2025 Copyright 2025 HIROSE ELECTRIC CO., LTD. All Rights Reserved.
In case of consideration for using Automotive equipment / device which demand high reliability, kindly contact our sales window correspondents.

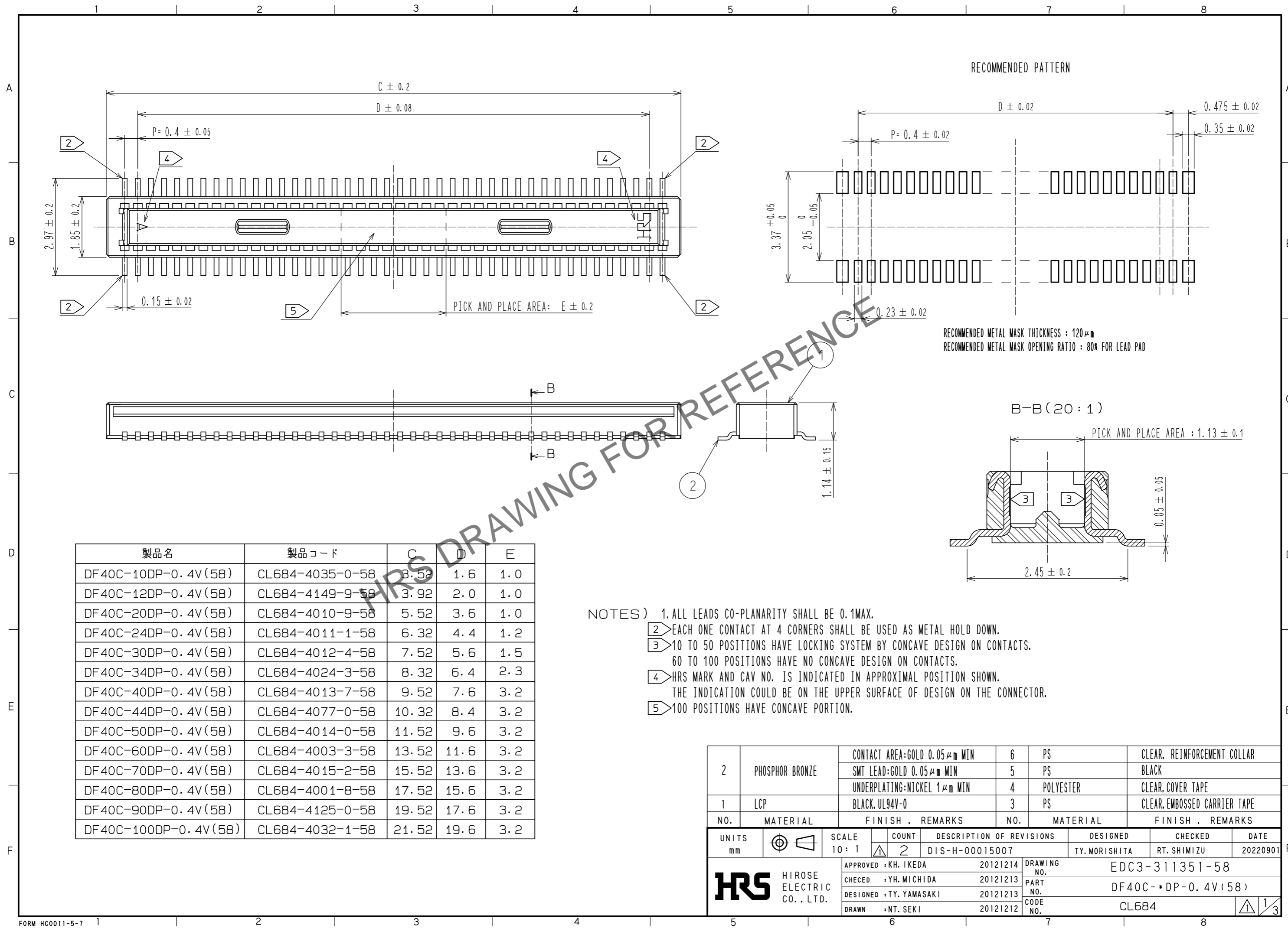

製品名	製品コード	C	D	E
DF40C-10DP-0.4V(58)	CL684-4035-0-58	3.52	1.6	1.0
DF40C-12DP-0.4V(58)	CL684-4149-9-58	3.92	2.0	1.0
DF40C-20DP-0.4V(58)	CL684-4010-9-58	5.52	3.6	1.0
DF40C-24DP-0.4V(58)	CL684-4011-1-58	6.32	4.4	1.2
DF40C-30DP-0.4V(58)	CL684-4012-4-58	7.52	5.6	1.5
DF40C-34DP-0.4V(58)	CL684-4024-3-58	8.32	6.4	2.3
DF40C-40DP-0.4V(58)	CL684-4013-7-58	9.52	7.6	3.2
DF40C-44DP-0.4V(58)	CL684-4077-0-58	10.32	8.4	3.2
DF40C-50DP-0.4V(58)	CL684-4014-0-58	11.52	9.6	3.2
DF40C-60DP-0.4V(58)	CL684-4003-3-58	13.52	11.6	3.2
DF40C-70DP-0.4V(58)	CL684-4015-2-58	15.52	13.6	3.2
DF40C-80DP-0.4V(58)	CL684-4001-8-58	17.52	15.6	3.2
DF40C-90DP-0.4V(58)	CL684-4125-0-58	19.52	17.6	3.2
DF40C-100DP-0.4V(58)	CL684-4032-1-58	21.52	19.6	3.2

- NOTES) 1. ALL LEADS CO-PLANARITY SHALL BE 0.1MAX.
 2. EACH ONE CONTACT AT 4 CORNERS SHALL BE USED AS METAL HOLD DOWN.
 3. 10 TO 50 POSITIONS HAVE LOCKING SYSTEM BY CONCAVE DESIGN ON CONTACTS.
 60 TO 100 POSITIONS HAVE NO CONCAVE DESIGN ON CONTACTS.
 4. HRS MARK AND CAV NO. IS INDICATED IN APPROXIMAL POSITION SHOWN.
 THE INDICATION COULD BE ON THE UPPER SURFACE OF DESIGN ON THE CONNECTOR.
 5. 100 POSITIONS HAVE CONCAVE PORTION.

NO.	MATERIAL	FINISH	REMARKS	NO.	MATERIAL	FINISH	REMARKS
2	PHOSPHOR BRONZE	CONTACT AREA:GOLD 0.05 μm MIN	6	PS	CLEAR, REINFORCEMENT COLLAR		
		SMT LEAD:GOLD 0.05 μm MIN	5	PS	BLACK		
		UNDERPLATING:NICKEL 1 μm MIN	4	POLYESTER	CLEAR, COVER TAPE		
1	LCP	BLACK, UL94V-0	3	PS	CLEAR, EMBOSSED CARRIER TAPE		

UNITS	SCALE	COUNT	DESCRIPTION OF REVISIONS	DESIGNED	CHECKED	DATE
mm	10 : 1	2	DIS-H-00015007	TY. MORISHITA	RT. SHIMIZU	20220901

APPROVED	DATE	DRAWING NO.
: KH. IKEDA	20121214	EDC3-311351-58
CHECKED	DATE	PART NO.
: YH. MICHIDA	20121213	DF40C- *DP-0.4V(58)
DESIGNED	DATE	CODE NO.
: TY. YAMASAKI	20121213	CL684
DRAWN	DATE	
: NT. SEKI	20121212	

Apr.1.2025 Copyright 2025 HIROSE ELECTRIC CO., LTD. All Rights Reserved.
In case of consideration for using Automotive equipment / device which demand high reliability, kindly contact our sales window correspondents.

△11. PLEASE REFER TO THE PRODUCT GUIDELINE ETAD-H1015 FOR DETAIL OF CONNECTOR HANDLING.

THE POSITION BETWEEN THE CONNECTOR AND PAD

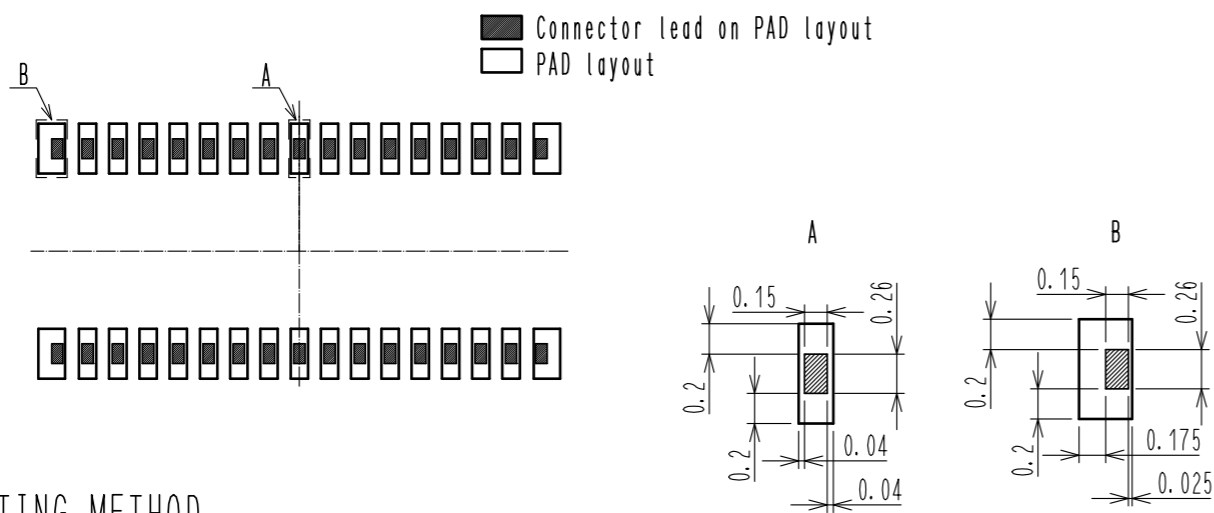

MATING METHOD

PLEASE MATE THE CONNECTOR BY HAND.

MATING PROCEDURE

- (1) FIND THE ALIGNMENT AREA TO THE CONNECTOR IN THE APPROPRIATE MATING POSITION.
 THIS CONNECTOR HAS AN ALIGNMENT CHAMBER(GUIDANCE RIBS) ON RECEPTACLE SIDE AND 'R' ON PLUG SIDE, SO THAT THE CONNECTOR WILL BE SELF-ALIGNED.
 WHEN THE CONNECTOR COMES TO THE APPROPRIATE POSITION, THE CONNECTOR GOES INTO THE ALIGNED POSITION.
 WHEN ALIGNED, IT CAN BE FELT BY HAND.

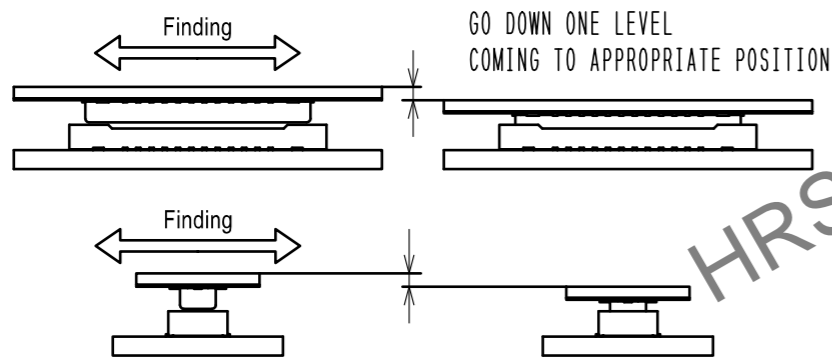

- (2) WHEN GUIDING, THE CONNECTORS ARE ALIGNED PARALLEL TO EACH OTHER, WITH LONGITUDINAL AND LATERAL MOVEMENTS RESTRICTED. MATE THEM PROPERLY BY APPLYING FORCE IN THIS CONDITION.

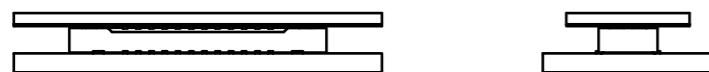

- (3) MAKE SURE THE CONNECTORS ARE MATED CORRECTLY. IF ONE SIDE IS FLOATING OR THE CONNECTORS ARE MATED IN ONE DIRECTION, UN-MATE THEM ONCE, AND THEN MATE THEM AGAIN, FOLLOWING THE PROCEDURES ABOVE FROM THE BEGINNING.

UN-MATING METHOD

PLEASE UN-MATE THE CONNECTOR BY HAND

- (1) UN-MATE THE CONNECTORS PARALLEL TO EACH OTHER. HOWEVER, IF THE CONNECTORS HAVE HIGH PIN COUNTS OR THINNER FPC AND STIFFENER, IT BECOMES MORE DIFFICULT TO DO SO.

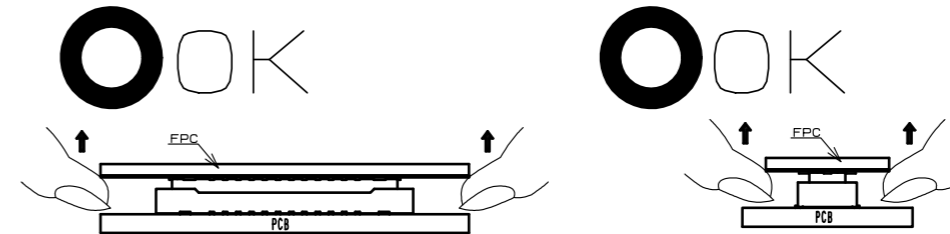

- (2) IF THE CONNECTOR CANNOT BE UN-MATED PARALLEL IT CAN BE REMOVED DIAGONALLY FROM THE PITCH DIRECTION. BE CAREFUL TO DO SO SINCE THIS ACTION APPLIES STRESS ON THE CONTACT.

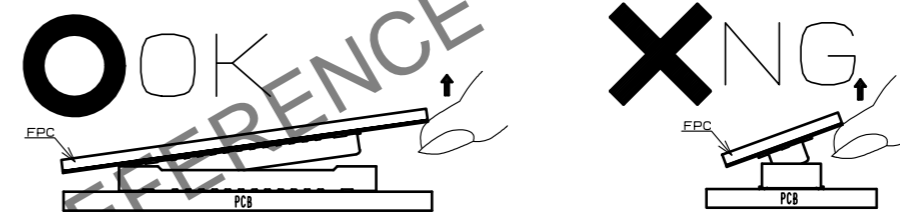

- (3) IF THE FPC IS NOT RIGID, THE CONNECTOR CAN BE BROKEN. PLEASE CHECK THE ACTION OF THE FPC TO BE USED REPEATEDLY AT THE TIME OF TRIAL PRODUCTION. BE CAREFUL TO UN-MATE THEM FROM THE PITCH DIRECTION, PULLING IT FROM THE CORNER CAN ALSO RISK TO PUTTING STRESS ON CONTACTS.

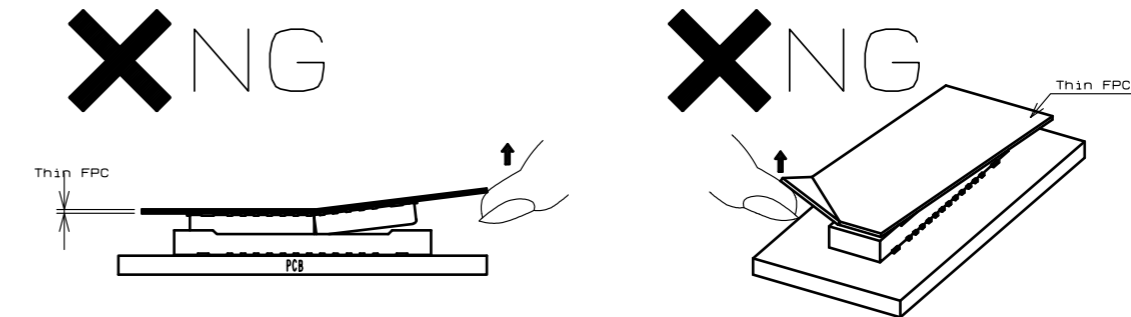

- (4) Caution for using multiple connectors.

Please avoid using more than a single mated pair of connectors between two sandwiched PCBs, like the picture on the below.
 Due to possible misalignment, connector breakage while and after mating may occur.

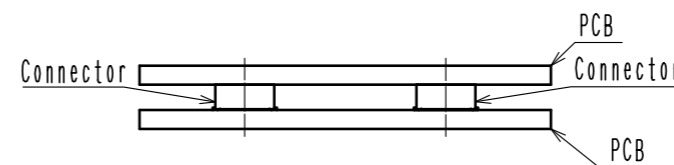

If using more than a single mated pair, please use divided boards for each connection.

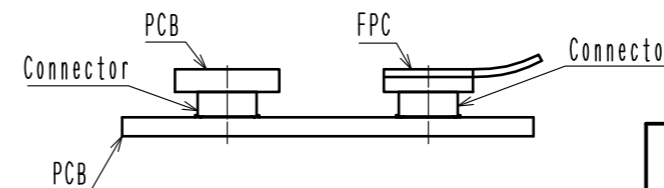

HRS	DRAWING NO.	EDC3-311351-58
	PART NO.	DF40C-*DP-0.4V(58)
	CODE NO.	CL684-4001-8-51
		3/3