

Apr.1.2026 Copyright 2026 HIROSE ELECTRIC CO., LTD. All Rights Reserved.
 本製品を車載用途などの高い信頼性が求められる機器にご使用の場合は、弊社までお問合せ下さい。

ELV. RoHS適合品
 ELV. RoHS COMPLIANT

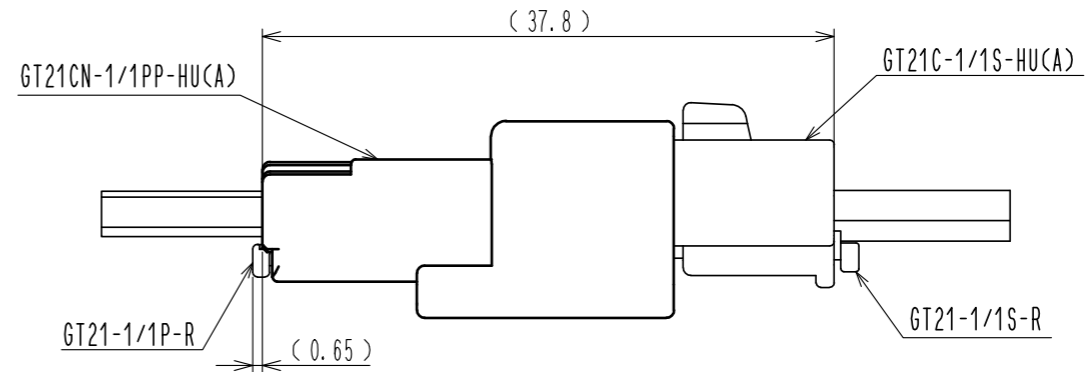
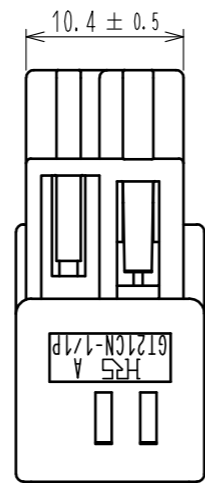

使用状態嵌合図
 MATED CONNECTORS

△ 形状変更
 Change in shape

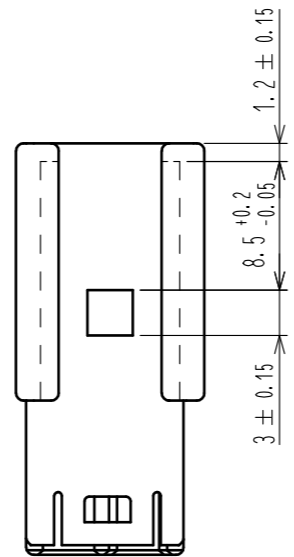
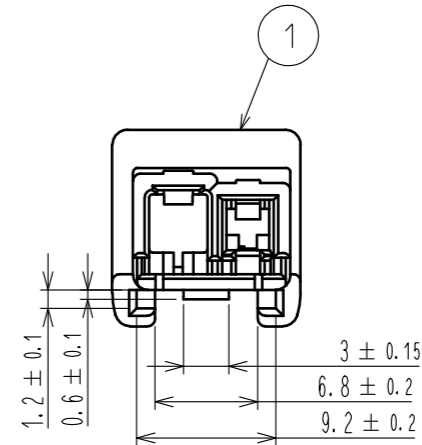
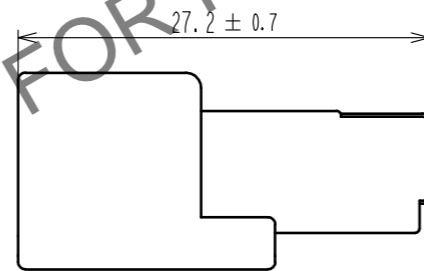
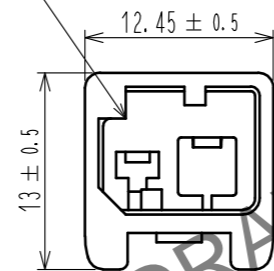
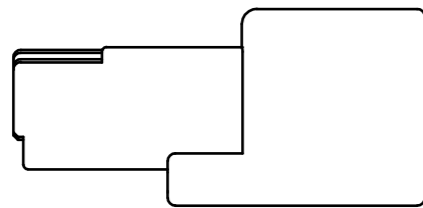

1	PBT	BROWN					
NO.	MATERIAL	FINISH . REMARKS	NO.	MATERIAL	FINISH . REMARKS		
UNITS	mm	SCALE	COUNT	DESCRIPTION OF REVISIONS		DESIGNED	CHECKED
		2 : 1	1	DIS-T-00006981		HK. WATANABE	MO. OKADA
APPROVED : KI. HIROKAWA		20170705		DRAWING NO.		ADC-377742-00-00	
CHECKED : KT. MAKI		20170704		PART NO.		GT21CN-1/1PP-HU(A)	
DESIGNED : TK. SUZUKI		20170704		CODE NO.		CL0771-0109-0-00	
DRAWN : TK. SUZUKI		20170704				1/1	