

**1. Scope**

This document specifies the process from crimping the DF22-series crimp contacts with wire (AWG10 – AWG16) to inserting crimped wires to crimping socket.

**2. Product number structure**

■ Connector

**DF22 B L – 2 S – 7.92 C**

① ② ③ ④ ⑤ ⑥ ⑦

① Series Name:DF22
② Form Type Sockets Blank:Standard height,standard lock B:Long type,standard lock C:Long type,ergonomic lock In-line plugs Blank:With panel stop A:Without panel stop
③ Guide key type Blank:Inside(Color:natural) R:Right side (Color:black) L:Left side (Color:red)
④ Number of contacts:1 to 5
⑤ Connector type S:Socket DS:Double-row socket EP:In-line plug DEP:Double-row in-line plug RS/P:Retainer
⑥ Contact pitch : 7.92mm
⑦ Type of housing C:Crimping housing Blank:Retainer

COUNT	DESCRIPTION OF REVISIONS	DESIGNED	CHECKED	DATE	
△					
名称 TITLE		 <b>HIROSE ELECTRIC CO., LTD.</b>			
DF22 Series Cable Assembly Procedure					
APPROVED	HS. OKAWA				16. 12. 09
CHECKED	TS. FUKUSHIMA				16. 12. 09
		DESIGNED	TS. KUMAZAWA	16. 12. 09	
		WRITTEN	TO. KUROMATSU	16. 12. 09	
技術指定書 TECHICAL SPECIFICATION		ETAD-H0798-00		△ 1 / 8	

## ■Contact

**DF22 A-1416 -SCF A**

① ② ③ ④

① Applicable wire Blank:UL1430 A:UL1015
② Applicable Conductor 1416:14 to 16 AWG 1012:10 to 12 AWG
③ Packaging SCF:Socket contacts/reel SC:Socket contacts/pack PCF:In-line plug contacts/reel PC:In-line plug contacts/pack
④ Plating specifications Blank:Tin plated A:Gold plated

**3. Process for harnessing****3.1. Cable stripping**

Strip cables in accordance with appointed“Crimping Quality Standards” (TAD-5024-\*\*\*).

In so doing, make sure there is no scratch on wire cores.

**3.2. Crimping**

Crimp contact with wire using appropriate applicator (AP109A-DF22#-\*\*\*\*) and check the crimping height and shape in accordance with the “Table of Crimping Conditions” and “Crimping Quality Standards”.

In the case of using a cabtyre cable, etc., perform crimping so that the terminal insertion direction is correct when it is inserted into the crimping socket.

	Crimping Quality Standards	Applicator
DF22-1416SCF	TAD-5024-060	AP109A-DF22-1416
DF22-1416SCFA		
DF22-1416PCF	TAD-5024-063	
DF22-1416PCFA		
DF22A-1416SCF	TAD-5024-061	AP109A-DF22A-1416
DF22A-1416SCFA		
DF22A-1416PCF	TAD-5024-064	
DF22A-1012SCF	TAD-5024-065	AP109A-DF22A-1012
DF22A-1012SCFA	TAD-5024-066	

### 3.3. Insert crimped contact to socket

Hold the wire of a crimped contact, and insert it to each contact hole of crimping sockets.

\*The figures show insertion to DF22-3S-7.92C(28) and DF22-1416SCF.

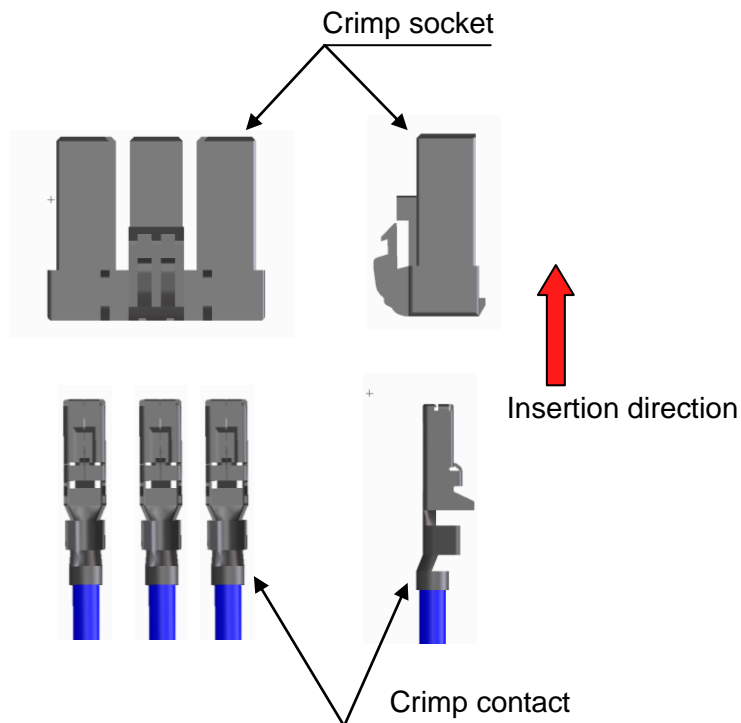

- How to insert wire into multipole contact

The insertion of wire in a bended state allows users to carry out the operation without any difficulty as shown in the drawing below.

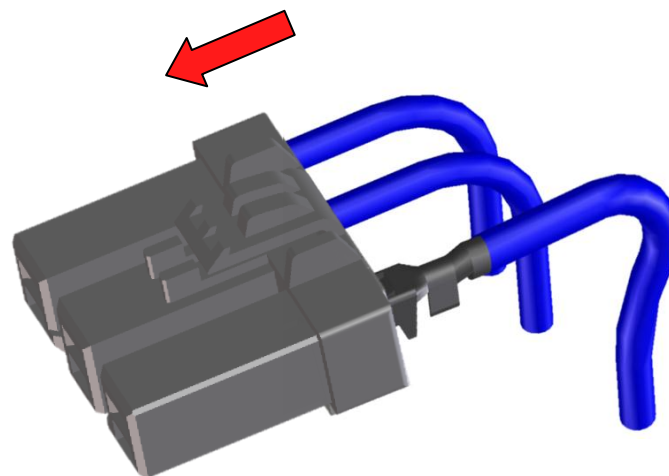

To maintain performance reliability, please note the following matter when you insert a contact.

Horizontal insertion:OK

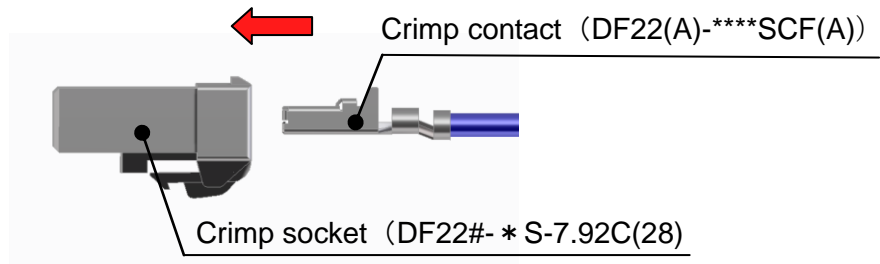

Insert the contact in a horizontal direction to the crimp socket.  
Please insert the contact at once until you hear click sound and feeling.

Tilted insertion:NG

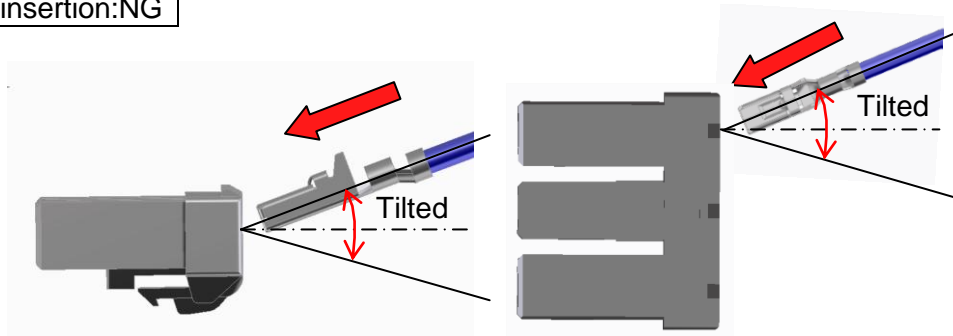

Insertion with tilted angle may deform the contact or crimp socket. Please Insert the contact without tilted.

Twisted insertion:NG

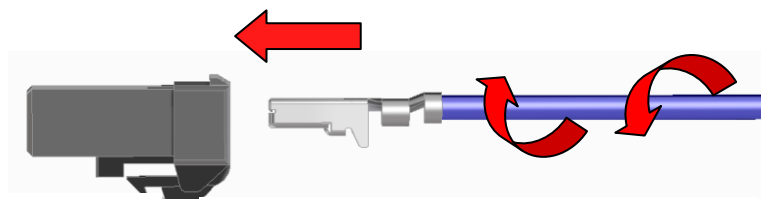

Twisting wire may deform the contact or crimp socket. Please Insert the contact without twisting wire.

Check the contacts inserted completely

Check that the lance of a crimped contact has been caught at the lance holder of the crimping case.  
(Slightly pull the wire to check.)

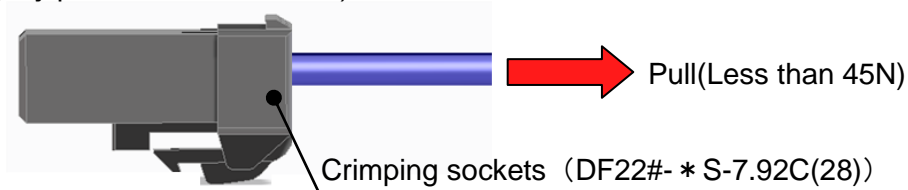

※Prohibited matters when checking contact insertion

When checking the contact insertion state, please do not bend the wires as shown in the drawing below. In case of thick core wire which is not very supple, and therefore, failure to observe this prohibition may apply stress to the connectors, which may cause the contacts to be disconnected.

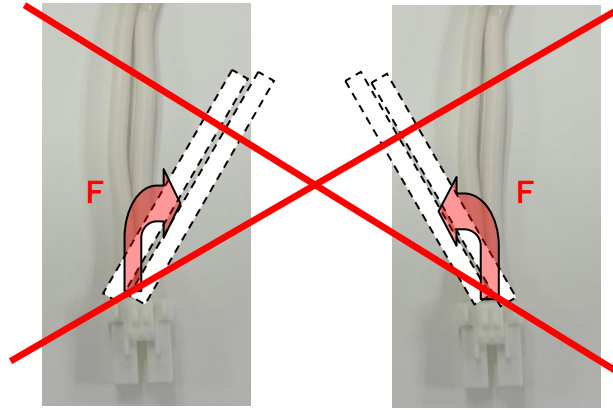

### 3.4. Removing contacts

Push down molded lance by using precision screwdriver, and pull out the wire simultaneously.

- Repair tool : Precision screwdriver (Flat-bladed screwdriver, blade width 1.4mm)

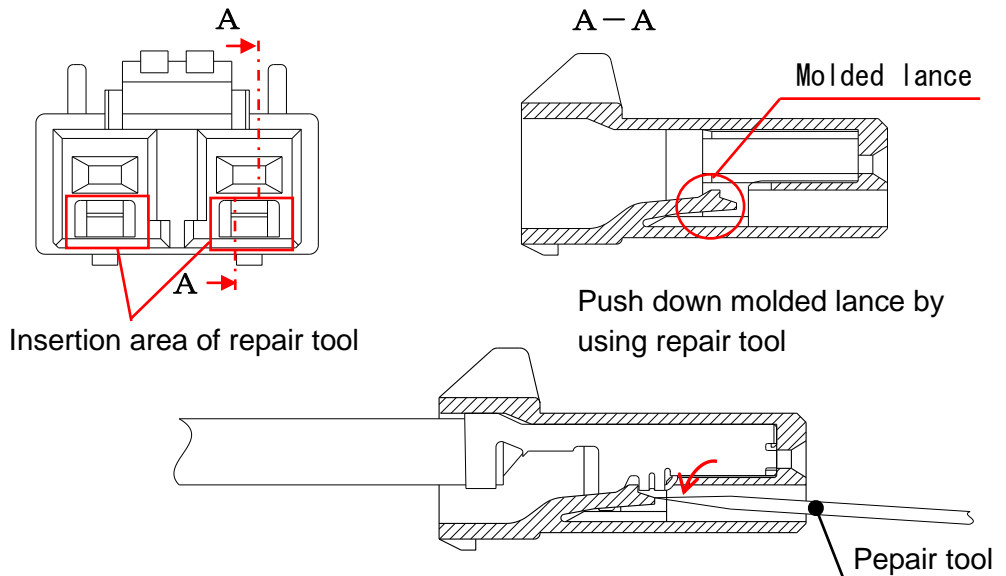

- By doing repair, the lance strength could be lower, therefore, do not reuse the crimp socket, and replace it to a new one.
- While removing contact, please pay attention not to injury by the protrusion of the contact.

### **3.5. Assemble retainer**

After checking crimped contact insertion completely, insert retainer to crimp socket shown below

- Retainer insertion direction  
See below for the Insertion direction.

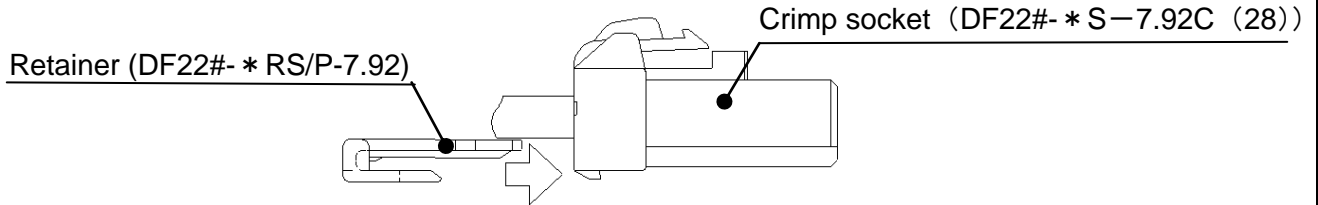

- To maintain performance reliability, please note the following matter when you assemble retainer.
  - ① Insert the retainer in a horizontal direction to the crimp socket.
  - ② Please insert the retainer at once until you hear click sound and feeling.
  - ③ Please make sure that the contact has been inserted properly so that the retainer can be installed.

### **3.6. Repair of the retainer**

Pull out and remove the retainer as shown below.

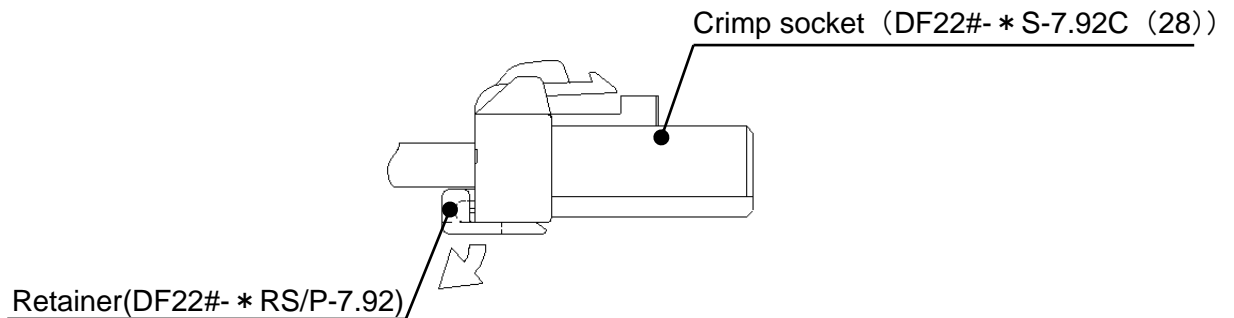

- By doing repair, the retainer lock strength could be lower, therefore, do not reuse the retainer, and replace it to a new one.

**(Reference)** How to install the retainer

- Retainer insertion direction

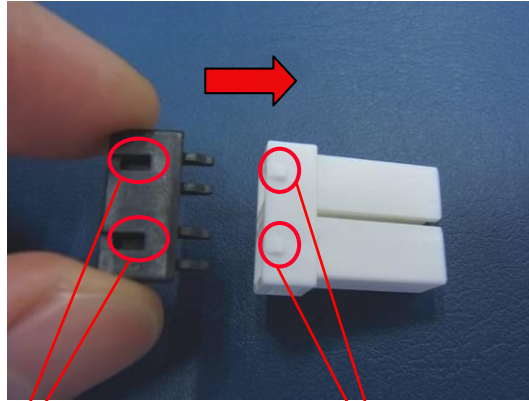

Retainer  
"Lock hole"

Crimp socket  
"Stopper"

- Good example (Inserted the retainer completely.)

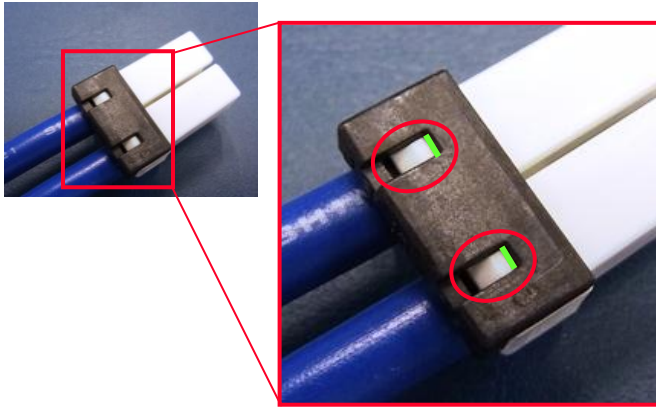

- Stopper is visible from the lock hole.
- Stopper face (Part of green line) is confirmable.

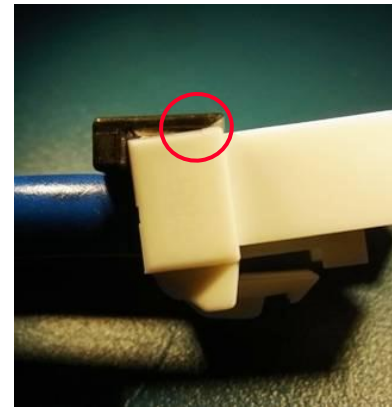

- Front edge of the retainer is touching to the crimp housing.

- NG (Incomplete insertion)

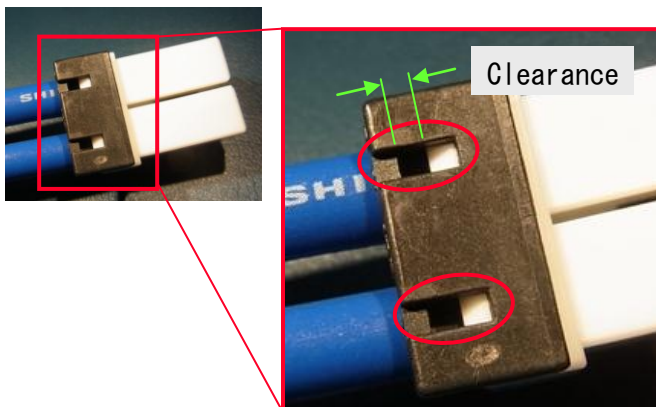

- Part of stopper is visible.
- Large clearance.

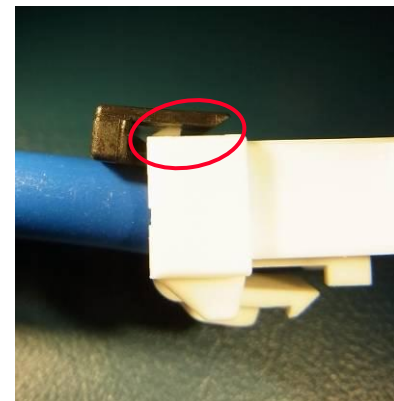

- Retainer is stranded on the stopper.

#### **4. Precautions for handling**

**\*Packing and storage**

For packaging and storage of cable assemblies, please consider not to apply excessive force to the lock portion by its own weight.

Long term storage under hot and humid condition could cause deformation of the lock portion and result in mating failure.

**\* Cable tying/Cable stripping length**

- Tying the cables near the socket may cause terminal disconnection, cable cut, unstable contact, etc. Thus, it is recommended to tie and strip the cables at a point at least 100 mm from the socket.

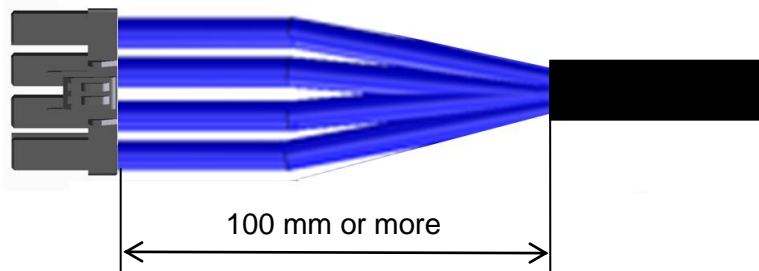

When using a multipole terminal, be aware that the strip length for the outside cables should be longer to provide it with a flexion portion, as well as to not apply any load such as excessive torsion.

