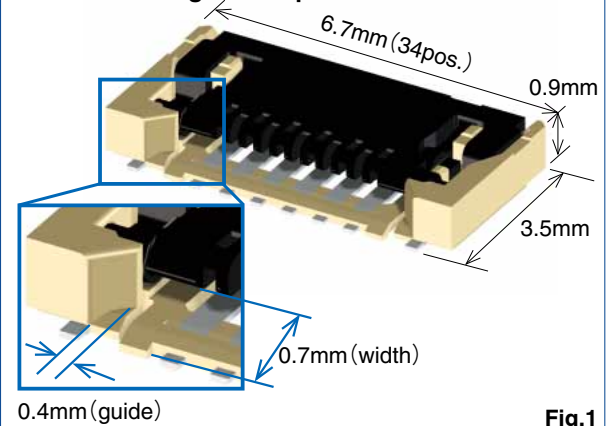

NEW

0.3mm Pitch, 0.9mm Height, Top Contact One Action Lock, High FPC Retention Force Connector

FH72 Series

**Dimension Diagram : 11pos.****Fig.1**

■Features

1. Space-saving design

- Space saving design with 0.3mm pitch, 4.0mm width, 0.9mm height (Fig.1).

2. Automatic one action lock design

One action locking by simply inserting FPC after mounting contributes to enhanced workability (Fig.2). (Lock release by operating the lock lever when removing.)

- Operation of the actuator is not required at the time of FPC mating.
- Can be inserted with one hand.
- Contributes to assembly time reduction.
- Lock lever will not be damaged by operation.
- Eliminates failures due to FPC movement during locking.

3. High FPC retention force

- The notches on both sides of FPC are held by the lock lever, generating a high FPC retention force in spite of the small size (Fig.3).

4. Easy FPC insertion

- Wide guide for easy FPC insertion (Fig.1).

5. Compatible with 0.2mm thickness FPC

- 3mm pitch connector compatible with 0.2mm standard thickness FPC (Appropriate rigidity of metal plates prevents FPC deformation and issues during inserting and fitting).

6. Detect FPC Mis-Mating with Original Structure

- Can detect mis-mating by checking the FPC insertion status with FPC pattern (Fig.4).

7. Environmental

- Halogen free

*AS defined by IEC 61249-2-21.

Br : 900ppm max, Cl : 900ppm max, Br+Cl : 1,500ppm max

One Action Lock

[Before mating]

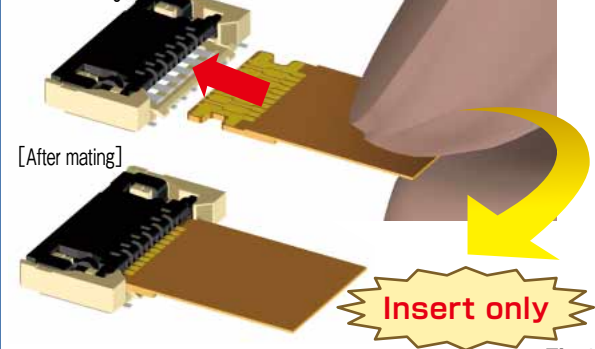

[After mating]

Fig.2

High FPC retention force due to lock design

[FPC being inserted]

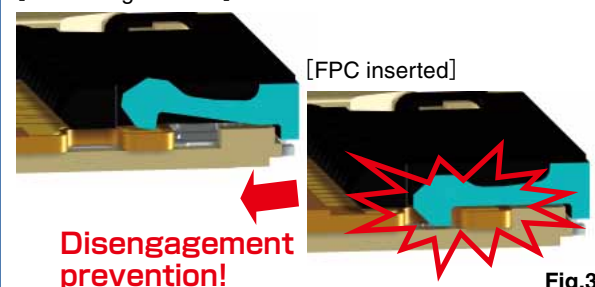
**Fig.3**

FPC mis-mating detection

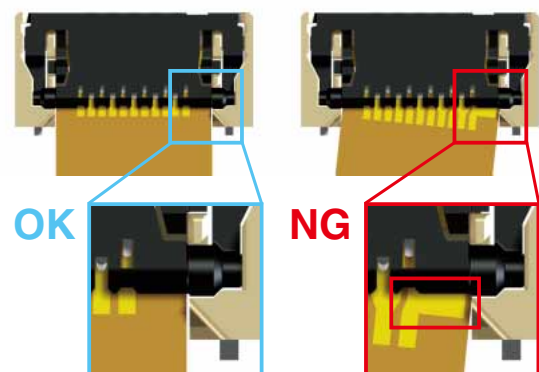
**Fig.4**

Product Specifications

Rating	Rated current	0.2A	Operating temperature range	-55 to +85°C (Note 1)	Storage Temperature range	-10 to +50°C (Note 2)
	Rated voltage	30V AC/DC	Operating humidity range	Relative humidity 90% max. (No condensation)	Storage humidity range	Relative humidity 90% max. (No condensation)

Adaptive FPC/FFC contact specifications	Thickness : = 0.2±0.03mm Gold plated contact traces
---	---

Item	Specification	Conditions
1. Insulation resistance	50MΩ min.	100V DC
2. Withstanding voltage	No flashover or insulation breakdown	90V AC rms / 1minute
3. Contact resistance	100mΩ max. * Including FPC conductor resistance	1mA (AC)
4. Durability (insertion/withdrawal)	Contact resistance : 100mΩ max. No damage, cracks, or parts dislocation	10 cycles
5. Vibration	No electrical discontinuity of 1μs or more Contact resistance : 100mΩ max. No damage, cracks, or parts dislocation	Frequency : 10 to 55Hz, single amplitude of 0.75mm, 10 cycles in each of the 3 directions
6. Shock	No electrical discontinuity of 1μs or more Contact resistance : 100mΩ max. No damage, cracks, or parts dislocation	Acceleration of 981m/s ² , duration of 6ms, sine half-wave waveform, 3 cycles in each of the 3 axes
7. Humidity (Steady state)	Contact resistance : 100mΩ max. Insulation resistance : 50MΩ min. No damage, cracks, or parts dislocation	96 hours at temperature of 40°C and humidity of 90% to 95%
8. Temperature cycle	Contact resistance : 100mΩ max. Insulation resistance : 50MΩ min. No damage, cracks, or parts dislocation	Temperature : -55°C→+15°C to +35°C→+85°C→ +15°C to +35°C Time : 30→ 2~3→ 30→ 2 to 3 (Minutes) 5 cycles
9. Resistance to soldering heat	No deformation of components affecting performance	Reflow : See recommended temperature profile (Page 8) Manual soldering : 350 ± 10°C for 5 seconds

Note 1 : Includes temperature rise caused by current flow.

Note 2 : The term "storage" refers to products stored for long period of time prior to mounting and use. Operating Temperature Range and Humidity Range covers non-conducting condition of installed connectors in storage, shipment or during transportation.

Materials / Finish

Part	Material	Color / Finish	UL standard
Insulator	LCP	Beige	UL94V-0
	Polyamide	Black	UL94V-0
Contact	Copper alloy	Gold plated	—

Product Number Structure

Refer to the chart below when determining the product specifications from the product number.

Please select from the product numbers listed in this catalog when placing orders.

FH 72 – 11S – 0.3 SHW (99)

① ② ③ ④ ⑤ ⑥

① Series Name : FH	⑤ Terminal type SHW : SMT horizontal staggered array type
② Series No. : 72	⑥ Specification Blank : Standard 6,000pcs/reel (99) : 500pcs/reel
③ No. of contacts : 11	
④ Connector pitch : 0.3mm	

Connector Dimensions

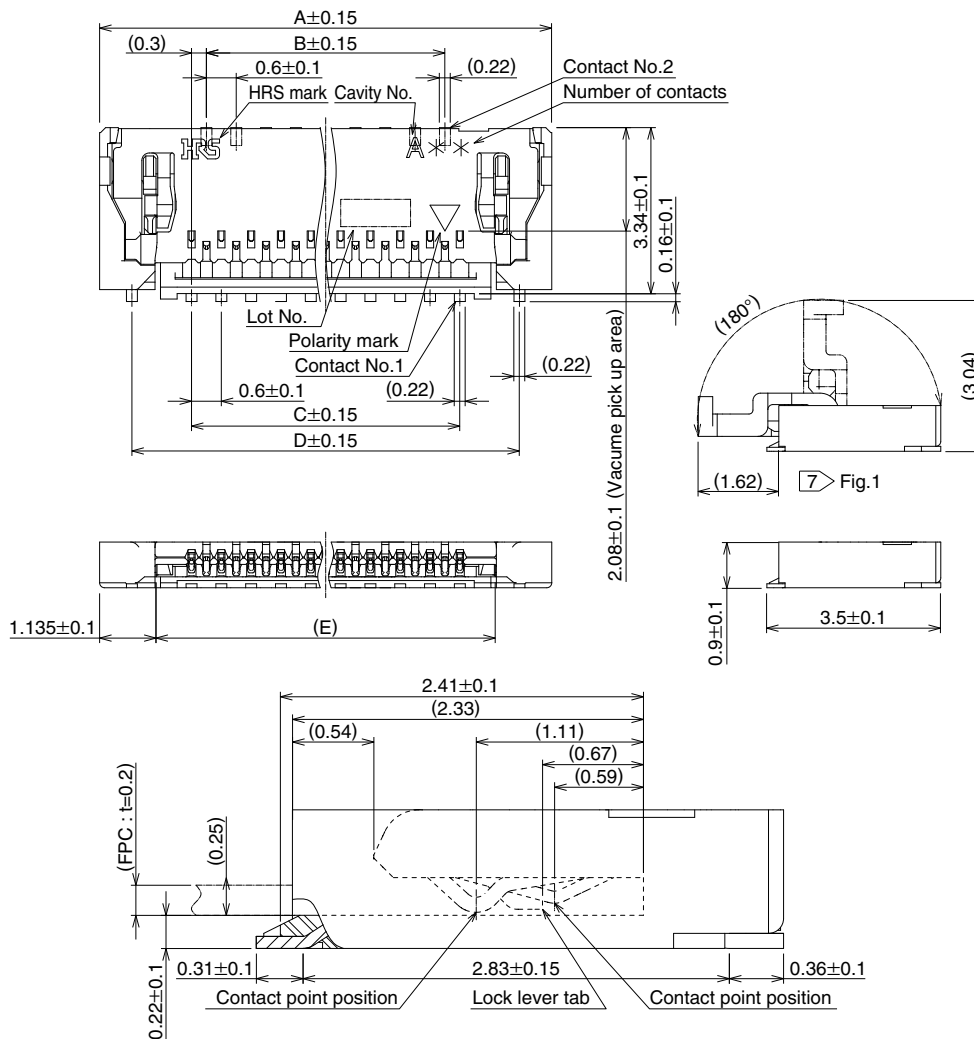

Note

- 1 : Dimensions in parentheses are reference.
- 2 : Level of contact and retention tab lead shall be 0.1 max.
- 3 : Packaged in tape and reel. See the packaging specifications for details.
- 4 : Please note that the appearance may change slightly in order to improve sink marks.
- 5 : Quality of product remains good even when dark spots occur on molded plastic.
- 6 : This product satisfies halogen free requirements defined as 900ppm maximum chlorine, 900ppm maximum bromine, and 1500ppm maximum total of chlorine and bromine.
- 7 Fig.1 indicates the lock lever in an open condition. FPC can be extracted by opening the lock lever more than 45°.

Unit : mm

Part No.	HRS No.	No. of Contacts	A	B	C	D	E
FH72-7S-0.3SHW(**)	Under planning (Note 1)	7	5.5	1.2	1.8	4.2	3.23
FH72-9S-0.3SHW(**)	Under planning (Note 1)	9	6.1	1.8	2.4	4.8	3.83
FH72-11S-0.3SHW(**)	580-5100-0 **	11	6.7	2.4	3.0	5.4	4.43
FH72-13S-0.3SHW(**)	Under planning (Note 1)	13	7.3	3.0	3.6	6.0	5.03
FH72-15S-0.3SHW(**)	Under planning (Note 1)	15	7.9	3.6	4.2	6.6	5.63
FH72-17S-0.3SHW(**)	Under planning (Note 1)	17	8.5	4.2	4.8	7.2	6.23
FH72-19S-0.3SHW(**)	Under planning (Note 1)	19	9.1	4.8	5.4	7.8	6.83
FH72-21S-0.3SHW(**)	Under planning (Note 1)	21	9.7	5.4	6.0	8.4	7.43
FH72-23S-0.3SHW(**)	Under planning (Note 1)	23	10.3	6.0	6.6	9.0	8.03
FH72-25S-0.3SHW(**)	Under planning (Note 1)	25	10.9	6.6	7.2	9.6	8.63
FH72-27S-0.3SHW(**)	Under planning (Note 1)	27	11.5	7.2	7.8	10.2	9.23
FH72-29S-0.3SHW(**)	Under planning (Note 1)	29	12.1	7.8	8.4	10.8	9.83
FH72-31S-0.3SHW(**)	Under planning (Note 1)	31	12.7	8.4	9.0	11.4	10.43

Note 1 : Contact positions without HRS No. are currently under planning.
Please contact Hirose for detailed information about product variations.

Recommended FPC Dimensions Diagram

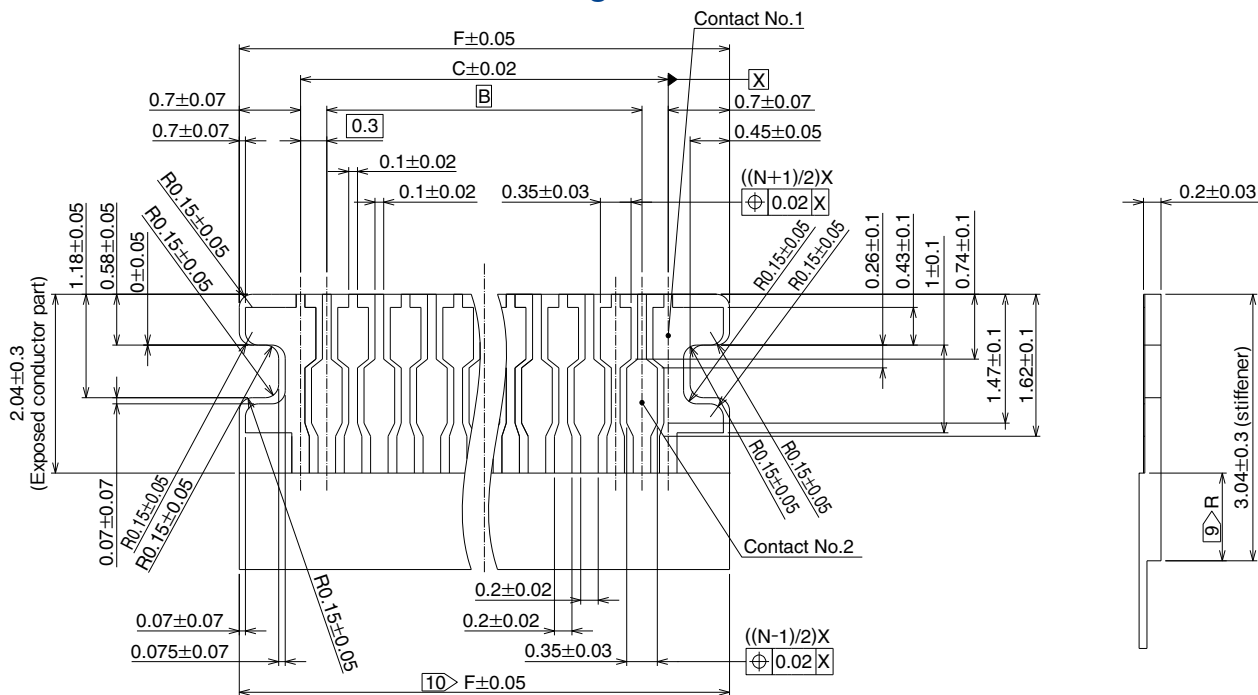

Note 9 When designing the FPC dimension R must be 0.5mm minimum.
 Note 10 Apply indicated tolerance to exposed part of conductor.

Unit : mm

Part No.	HRS No.	No. of contacts	B	C	F
FH72-7S-0.3SHW(**)	Under planning (Note 1)	7	1.2	1.8	3.2
FH72-9S-0.3SHW(**)	Under planning (Note 1)	9	1.8	2.4	3.8
FH72-11S-0.3SHW(**)	580-5100-0 **	11	2.4	3.0	4.4
FH72-13S-0.3SHW(**)	Under planning (Note 1)	13	3.0	3.6	5.0
FH72-15S-0.3SHW(**)	Under planning (Note 1)	15	3.6	4.2	5.6
FH72-17S-0.3SHW(**)	Under planning (Note 1)	17	4.2	4.8	6.2
FH72-19S-0.3SHW(**)	Under planning (Note 1)	19	4.8	5.4	6.8
FH72-21S-0.3SHW(**)	Under planning (Note 1)	21	5.4	6.0	7.4
FH72-23S-0.3SHW(**)	Under planning (Note 1)	23	6.0	6.6	8.0
FH72-25S-0.3SHW(**)	Under planning (Note 1)	25	6.6	7.2	8.6
FH72-27S-0.3SHW(**)	Under planning (Note 1)	27	7.2	7.8	9.2
FH72-29S-0.3SHW(**)	Under planning (Note 1)	29	7.8	8.4	9.8
FH72-31S-0.3SHW(**)	Under planning (Note 1)	31	8.4	9.0	10.4

Note 1 : Contact positions without HRS No. are currently under planning.
 Please contact Hirose for detailed information about product variations.

FPC Construction (Recommended Specifications)

Material Name	Material	Thickness (μm)
Covering film	Polyimide 1mil	(25)
Cover adhesive		(25)
Surface treatment	1 to 5μm nickel underplated 0.2μm gold under plated	(4)
Conductor copper foil	Cu 1oz	35
Base adhesive	Heat-hardened adhesive	25
Base film	Polyimide 1mil	25
Reinforcement material adhesive	Heat-hardened adhesive	35
Stiffener	Polyimide 5mil	75

Note 1. Material composition of FPC is a reference example. Please adjust the thickness of the FPC mating section to 0.2±0.03mm in reference to the material composition.
 2. For the details of the material composition, please contact each FPC manufacturer.

◆Packaging Specifications

●Embossed Carrier Tape Dimensions

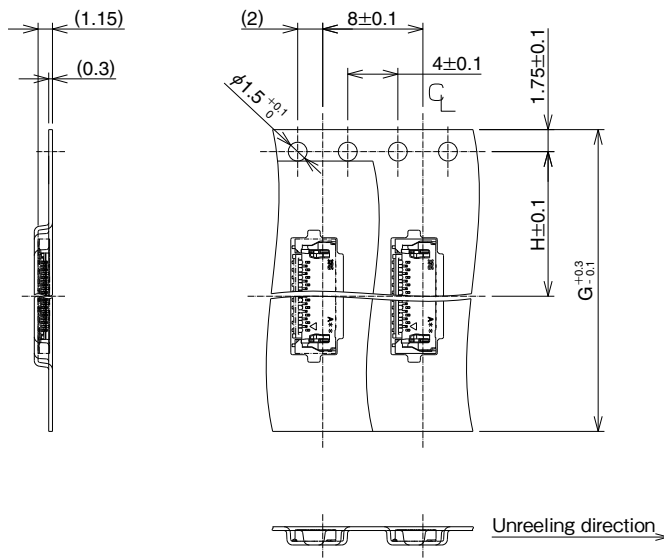

●Reel Dimensions

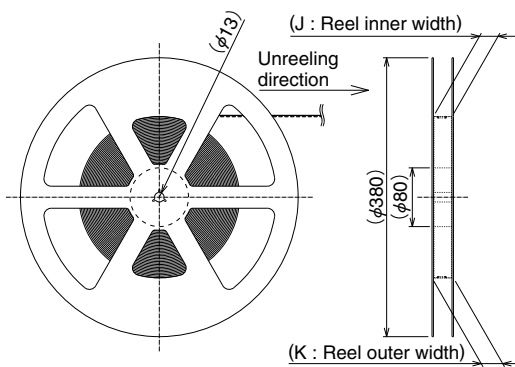

●Leader, Trailer Dimensions

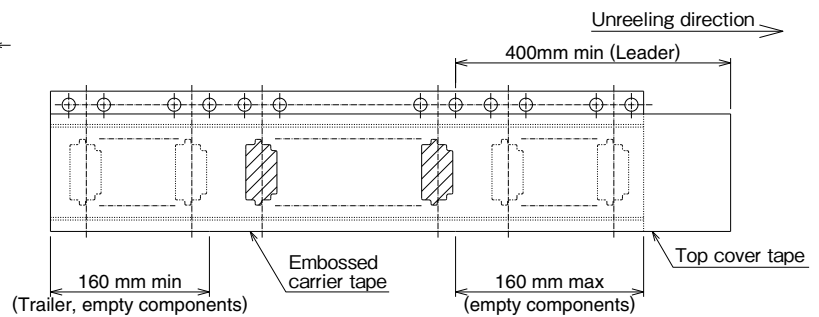

Unit : mm

Part No.	HRS No.	No. of contacts	G	H	J	K
FH72-7S-0.3SHW(**)	Under planning (Note 1)	7	16	7.5	17.4	21.4
FH72-9S-0.3SHW(**)	Under planning (Note 1)	9				
FH72-11S-0.3SHW(**)	580-5100-0 **	11	24	11.5	25.4	29.4
FH72-13S-0.3SHW(**)	Under planning (Note 1)	13				
FH72-15S-0.3SHW(**)	Under planning (Note 1)	15				
FH72-17S-0.3SHW(**)	Under planning (Note 1)	17				
FH72-19S-0.3SHW(**)	Under planning (Note 1)	19				
FH72-21S-0.3SHW(**)	Under planning (Note 1)	21				
FH72-23S-0.3SHW(**)	Under planning (Note 1)	23				
FH72-25S-0.3SHW(**)	Under planning (Note 1)	25				
FH72-27S-0.3SHW(**)	Under planning (Note 1)	27				
FH72-29S-0.3SHW(**)	Under planning (Note 1)	29				
FH72-31S-0.3SHW(**)	Under planning (Note 1)	31				

Note 1 : Contact positions without HRS No. are currently under planning.
Please contact Hirose for detailed information about product variations.

◆ Temperature Profile

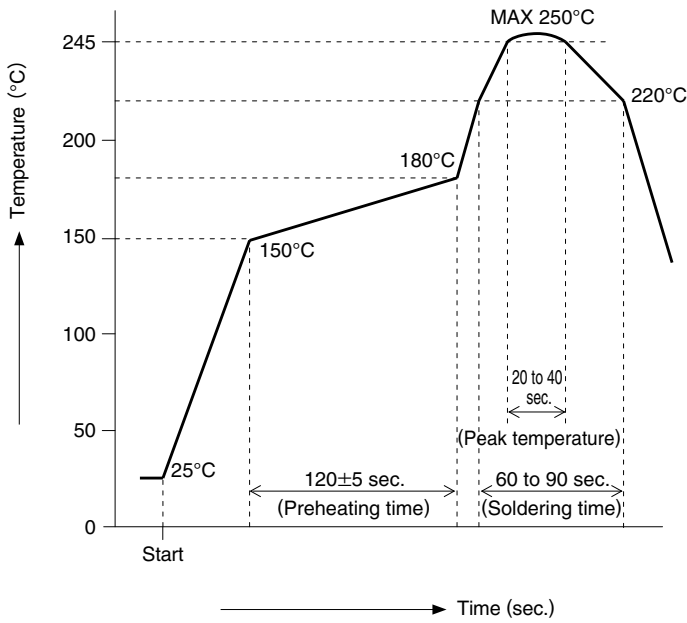

Applicable Conditions

- Reflow method : IR/Hot air
- Reflow environment : Room air
- Solder : Paste type Sn/3.0Ag/0.5Cu
(M705-GRN360-K2-V made by Senju Metal Industry Co.)
- Test PCB : PCB material and size
Glass epoxy 45×25×1mm
Land size per recommendation on page 4.
- Metal mask : Thickness and opening size per recommendation on page 4.

This temperature profile is based on the above conditions. It may vastly depending on solder paste type, manufacturer, PCB size and mounting materials. Please use only after checking the mounting conditions.

◆ Connector operation and points to note

[Operation Method]

As this connector is a small-sized, thin product, care needs to be taken when handling. Please check the following before use.

1. Initial Condition

- ① The product is delivered with the lock lever closed. The lock lever does not need to be operated other than when removing the FPC.

2. FPC insertion method

- ① Insert FPC with the conductor surface facing upwards, horizontally to the board surface until fully inserted.

[Caution]

- During FPC insertion do not twist the FPC vertically, laterally or diagonally. Doing so may result in deformation of the contacts and contact failure.

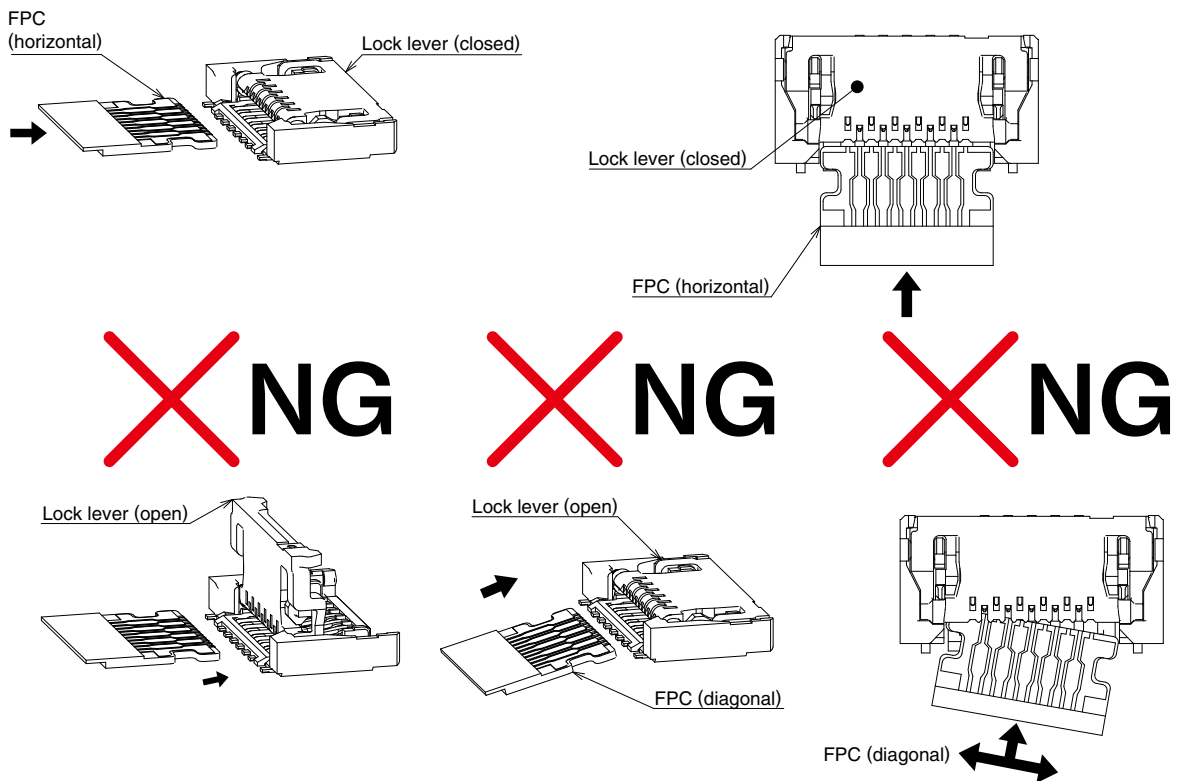

3. Checking the FPC insertion status

After FPC is completely inserted visually inspect the FPC insertion status.

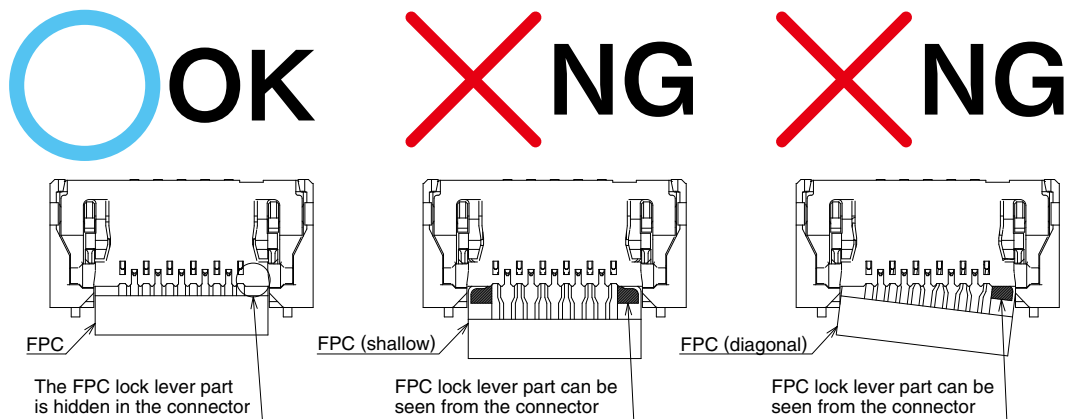

◆ Connector operation and points to note

[Operation Method]

4. FPC extraction method

① Push up the lock lever slowly and release the lock.

[Caution]

- The lock lever cannot be opened over 180°. Do not open it over this angle.
- After releasing the lock lever, do not touch the contact.
- Do not raise, pull, or twist the lock lever.

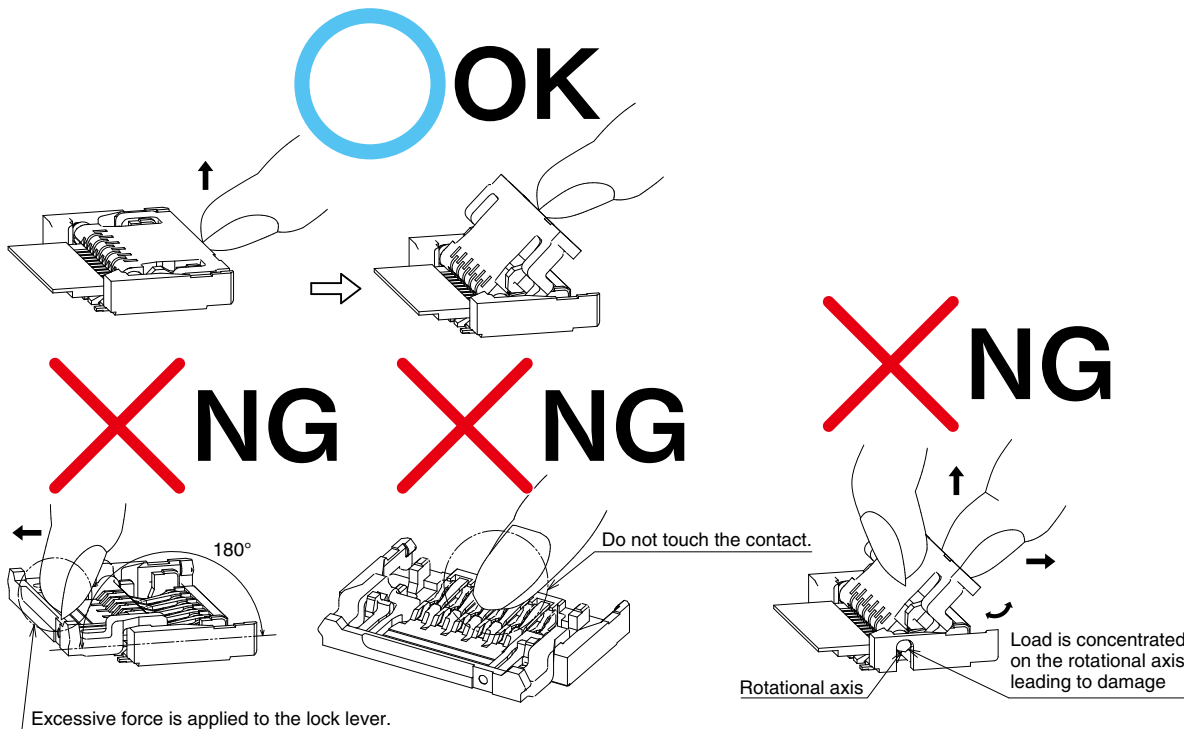

② After releasing the lock lever, extract the FPC in the horizontal direction.

③ After remove of the FPC, close the lock lever.

[Caution]

- Do not pull out FPC while the lock lever is not opened to 45° or more.
- Ensure both ends of the lock lever are closed.

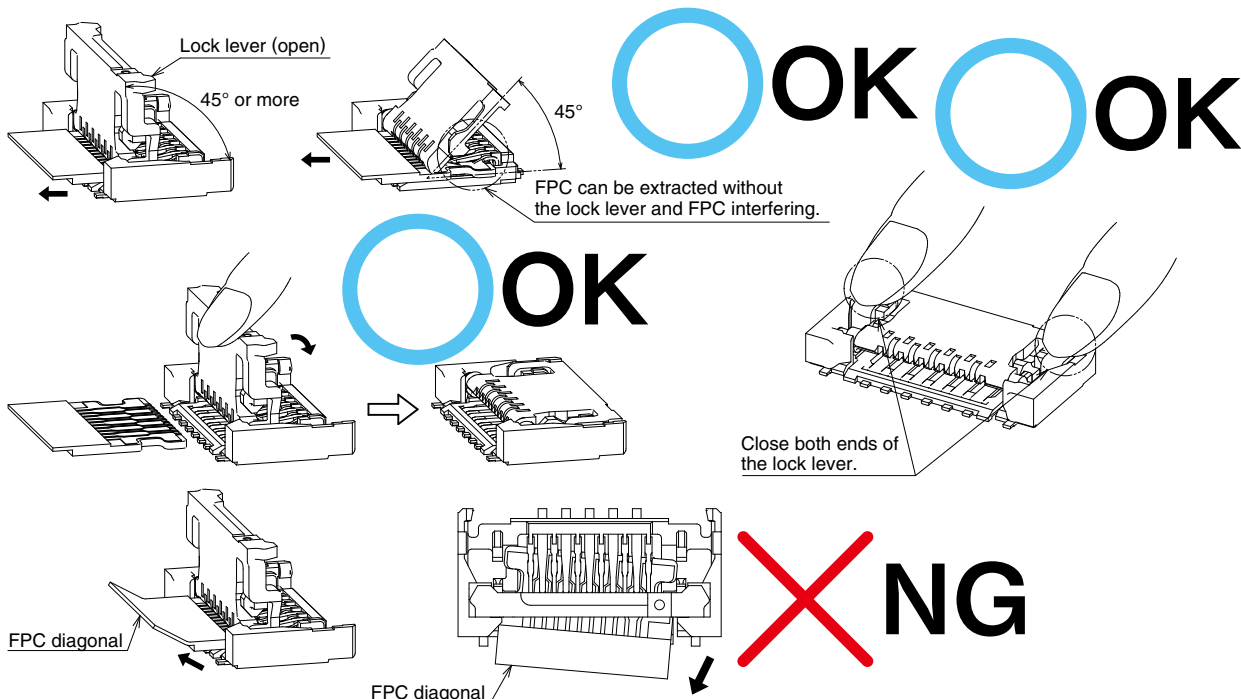

◆ Connector operation and points to note

[Operation Method]

5. FPC routing

- ① When routing the FPC please do not apply a load as it may cause FPC disconnection and damage.
It also may cause additional load to the connector resulting in poor connection and other issues.

[Caution]

- Make sure the FPC's stiffener does not touch the chassis.
- When designing and assembling the FPC avoid applying stress by pulling, pushing and loosening on the connector. Additionally, avoid pulling up and down on the FPC
- When designing and assembling the FPC after cabling avoid pulling the FPC and route the wire with slack. In this case the stiffener should be parallel to the PCB.
- Do not mount other components under the FPC's stiffener.

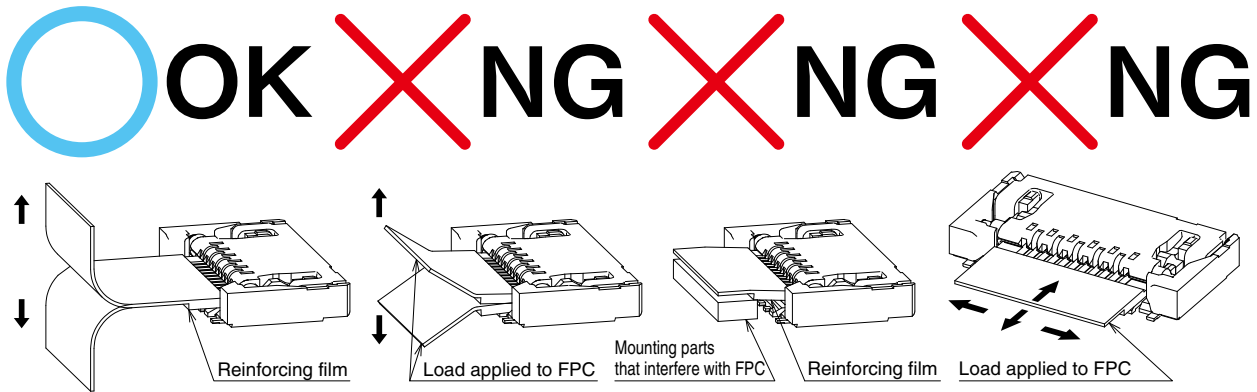

[Cautions for mounting PCB]

◆ PCB Warping

Minimize PCB warping as much as possible.
Lead co-planarity including reinforced metals is 0.1mm or less.
Too much PCB warping may result in a soldering failure.

◆ FPC Mounting

When mounted on FPC, be sure to provide a reinforcing plate to ease handling.
We recommend a reinforcing plate of 0.3mm or thicker made of glass epoxy material.

◆ Load to Connector

Do not apply an external force to the connector greater than 1.0N prior to mounting.
Additionally do not insert the FPC or operate the connector before mounting.

◆ Load to PCB

- Splitting a large PCB into several pieces
 - Screwing the PCB
- Avoid the handling described above so that no force is exerted on the PCB during the assembly process.
Otherwise, the connector may become defective.

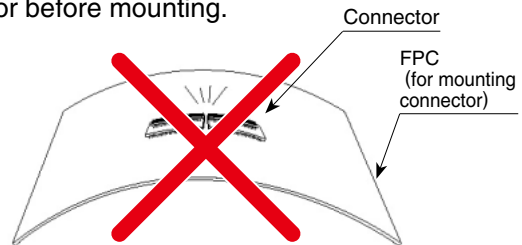

◆ Instructions on manual soldering

Follow the instructions shown below when soldering the connector manually during repair etc.

1. Do not perform any reflow or hand soldering operation while FPC is inserted in the connector.
2. Do not apply extreme heat, or allow the soldering iron to touch anything other than the connector lead.
This could cause the connector to be deformed or melted.
3. Do not supply excessive solder (flux).
If excessive solder (flux) is applied to the contact, the solder or flux could adhere on the contact point and cause contact failure.

USA:

HIROSE ELECTRIC (U.S.A.), INC. HEADQUARTERS CHICAGO OFFICE
2300 Warrenville Road, Suite 150,
Downers Grove, IL 60515
Phone : +1-630-282-6700
<http://www.hirose.com/us/>

USA:

HIROSE ELECTRIC (U.S.A.), INC. SAN JOSE OFFICE
2841 Junction Ave, Suite 200
San Jose, CA. 95134
Phone : +1-408-253-9640
Fax : +1-408-253-9641
<http://www.hirose.com/us/>

USA:

HIROSE ELECTRIC (U.S.A.), INC. DETROIT OFFICE (AUTOMOTIVE)
17197 N. Laurel Park Drive, Suite 253,
Livonia, MI 48152
Phone : +1-734-542-9963
Fax : +1-734-542-9964
<http://www.hirose.com/us/>

USA:

HIROSE ELECTRIC (U.S.A.), INC. BOSTON OFFICE
300 Brickstone Square Suite 201,
Andover, MA 01810
Phone : +1-978-662-5255

THE NETHERLANDS:

HIROSE ELECTRIC EUROPE B.V.
Hogehillweg #8 1101 CC Amsterdam Z-0
Phone : +31-20-6557460
Fax : +31-20-6557469
<http://www.hirose.com/eu/>

GERMANY:

HIROSE ELECTRIC EUROPE B.V. GERMAN BRANCH
Schoenbergstr. 20, 73760 ostfildern
Phone : +49-711-456002-1
Fax : +49-711-456002-299
<http://www.hirose.com/eu/>

GERMANY:

HIROSE ELECTRIC EUROPE B.V. NUREMBERG OFFICE
Neumeyerstrasse 22-26, 90411 Nurnberg
Phone : +49-911 32 68 89 63
Fax : +49-911 32 68 89 69
<http://www.hirose.com/eu/>

GERMANY:

HIROSE ELECTRIC EUROPE B.V. HANOVER OFFICE
Bayernstr. 3, Haus C 30855 Langenhagen, Germany
Phone : +49-511 97 82 61 30
Fax : +49-511 97 82 61 35
<http://www.hirose.com/eu/>

FRANCE:

HIROSE ELECTRIC EUROPE B.V. PARIS OFFICE
130 Avenue Joseph Kessel, Bat E, 78960
Voisins le Bretonneux, France
Phone : +33-1-85764886
Fax : +33-1-85764823
<http://www.hirose.com/eu/>

UNITED KINGDOM:

HIROSE ELECTRIC EUROPE BV (UK BRANCH)
4 Newton Court, Kelvin Drive, Knowlhill,
Milton Keynes, MK5 8NH
Phone : +44-1908 202050
Fax : +44-1908 202058
<http://www.hirose.com/eu/>

CHINA:

HIROSE ELECTRIC (CHINA) CO., LTD. (SHANGHAI, HEADQUARTERS)
18, Enterprise Center Tower 2, 209# Gong He
Road, Jing'an District, Shanghai, CHINA 200070
Phone : +86-21-6391-3355
Fax : +86-21-6391-3335
<http://www.hirose.com/cn/>

CHINA:

HIROSE ELECTRIC (CHINA) CO.,LTD. BEIJING BRANCH
A1001, Ocean International Center, Building 56# East 4th
Ring Middle Road, ChaoYang District, Beijing, 100025
Phone : +86-10-5165-9332
Fax : +86-10-5908-1381
<http://www.hirose.com/cn/>

CHINA:

HIROSE ELECTRIC (CHINA) CO., LTD. SHENZHEN BRANCH
Room 09-13, 19/F, Office Tower Shun Hing Square, Di Wang Commercial Centre,
5002 Shen Nan Dong Road, Shenzhen City, Guangdong Province, 518008
Phone : +86-755-8207-0851
Fax : +86-755-8207-0873
<http://www.hirose.com/cn/>

HONG KONG:

HIROSE ELECTRIC HONGKONG TRADING CO., LTD.
Room 1001, West Wing, Tsim Sha Tsui Centre, 66
Mody Road, Tsim Sha Tsui East, Kowloon, Hong Kong
Phone : +852-2803-5338
Fax : +852-2591-6560
<http://www.hirose.com/hk/>

TAIWAN:

HIROSE ELECTRIC TAIWAN CO., LTD.
103 8F, No.87, Zhengzhou Rd., Taipei
Phone : +886-2-2555-7377
Fax : +886-2-2555-7355
<http://www.hirose.com/tw/>

KOREA:

HIROSE KOREA CO.,LTD.
143, Gongdan 1-daero, Siheung-si,
Gyeonggi-do, 15084, Korea
Phone : +82-31-496-7000
Fax : +82-31-496-7100
<http://www.hirose.co.kr/>

SINGAPORE:

HIROSE ELECTRIC SINGAPORE PTE. LTD.
03, Anson Road, #20-01, Springleaf Tower,
Singapore 079909
Phone : +65-6324-6113
Fax : +65-6324-6123
<http://www.hirose.com/sg/>

INDIA:

HIROSE ELECTRIC SINGAPORE PTE. LTD. DELHI LIAISON OFFICE
Office NO.552, Regus-Green Boulevard, Level5, Tower C,
Sec62, Plot B-9A, Block B, Noida, 201301, Uttar Pradesh, India
Phone : +91-12-660-8018
Fax : +91-120-4804949
<http://www.hirose.com/sg/>

INDIA:

HIROSE ELECTRIC SINGAPORE PTE. LTD. BANGALORE LIAISON OFFICE
Unit No-403, 4th Floor, No-84, Barton Centre, Mahatma
Gandhi (MG) Road, Bangalore 560 001, Karnataka, India
Phone : +91-80-4120 1907
Fax : +91-80-4120 9908
<http://www.hirose.com/sg/>

MALAYSIA:

PENANG REPRESENTATIVE OFFICE
73-3-1, Ideal@The One, Jalan Mahsuri, Bayan
Lepas Penang, 11950, Malaysia
Phone : +604-648-5536
<http://www.hirose.com/sg/>

THAILAND:

BANGKOK OFFICE (REPRESENTATIVE OFFICE)
Unit 4703, 47th FL., 1 Empire Tower, South Sathorn
Road, Yannawa, Sathorn, Bangkok 10120 Thailand
Phone : +66-2-686-1255
Fax : +66-2-686-3433
<http://www.hirose.com/sg/>



HIROSE ELECTRIC CO.,LTD.

2-6-3,Nakagawa Chuoh,Tsuzuki-Ku,Yokohama-Shi 224-8540,JAPAN
TEL: +81-45-620-3526 Fax: +81-45-591-3726
<http://www.hirose.com>
<http://www.hirose-connectors.com>