

Push-on Bayonet Lock Miniature Waterproof Connectors

HR34B Series



Push-on Bayonet Lock

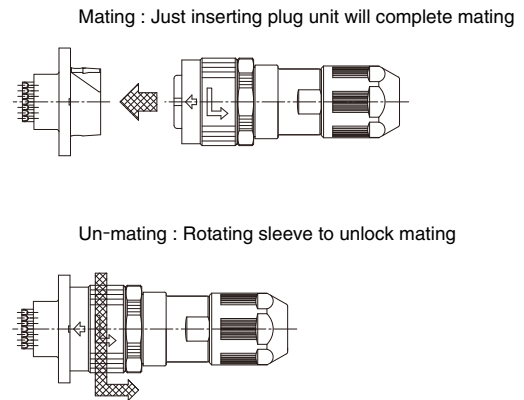

fig.1

■ Features

1. Water and dust protection

- IP67 or more (IP68) water and dust protection rating when fully mated.
- Resistant to industrial grade oils.
- 4-position receptacles are sealed against water penetration when mounted on the panel - no protective cap is required.

2. Easy and precise mating

- Mating: Just inserting plug unit completes mating
Unmating: Rotating sleeve counterclockwise unlocks connectors (fig.1)
- Marking helps align plug with receptacle when mating.
- 3 guide keys make blind mating possible.
(Receptacle structure prevents plug from damaging receptacle terminals)

3. Multi-directional cable exit

Right angle plugs allow the cable to exit in 8 directions, in 45° increments.(fig.2)

4. Safty standards

The 4-position connectors meet requirements of TÜV standard.

5. Wide variation

Cable exit directions

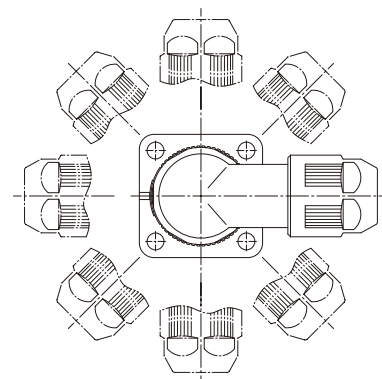

fig.2

Item	
Number of positions	4,10
Connector type	straight plug,right angle plug,receptacle
Terminations(plug)	solder,crimp
Terminations(receptacle)	wire solder
Conduit material	plastic,metal
Applicable cable size(Reference)	(ϕ 5.7~6.5), (ϕ 6.5~7.3), (ϕ 8.0~9.0)

■ Product Specifications

Ratings	Current rating	10 pos. : 3A 4 pos. : 5A	Operating temperature range	-25°C to 125°C
	Voltage rating	10 pos. : 200V AC, 250V DC 4 pos. : 200V AC, 200V DC (Pollution degree 3) 400V AC, 400V DC (Pollution degree 2)	Storage temperature range	-10°C to 60°C

Item	Specification	Conditions
1.Contact resistance	20mΩ max.	1A DC
2.Insulation resistance	1,000MΩ min.	500V DC
3.Withstanding voltage	No flashover or insulation breakdown	10 pos. : 900V AC / 1 minute 4 pos. : 2,000V AC / 1 minute
4.Vibration	No electrical discontinuity of 10μs or longer	Frequency : 10 to 500 Hz/cycle, total amplitude of 0.75 mm, 98m/s ² each, 3 hours in 3 axis.
5.Shock	No electrical discontinuity of 10μs or longer	Acceleration of 490 m/s ² , 11 ms duration, 3 axis, each for 3 hours
6.Durability (Mating / un-mating)	Contact resistance : 30mΩ max.	500 cycles
7.Temperature cycle	Insulation resistance : 500MΩ min.	Temperature: -55°C → +15° to +35°C → +85°C → +15° to +35°C Time : 30 min. → 2 to 3 min. → 30 min. → 2 to 3 min. 5 cycles
8.Humidity	Insulation resistance : 50MΩ min. (at high humidity) Insulation resistance : 500MΩ min. (when dry)	336 hours at 71°C, and humidity of 95%
9.Water protection	No water penetration inside connector	At the depth of 1meters for 0.5 hours.

■ Materials / Finish

● Plugs

Part	Material	Finish	Remarks
Outer shell	Zinc alloy, aluminum alloy, and polyamide resin (black)	Black chrome plating, black chromate finish (Trivalent Chromium)	_____
Insulator	PPS	Color : Black	UL94V-0
Female contacts	10 pos.	Phosphor bronze	Gold plated
	4 pos.	Copper alloy	Silver plated
O-ring Gasket	Fluororubber, Nitrile hydride rubber	_____	_____

● Receptacles

Part	Material	Finish	Remarks
Outer shell	Zinc alloy	Black chromate finish (Trivalent Chromium)	_____
Insulator	PPS	Color : Black	UL94V-0
Male contacts	10 pos.	Copper alloy	Gold plated
	4 pos.	Brass	Silver plated
Ground contact	4 pos.	Brass	Silver plated
O-ring	Fluororubber	_____	_____

■ Product Number Structure

● Plugs

HR34B - 12 WP A - 10 S - X (**)
 ① ② ③ ④ ⑤ ⑥ ⑦ ⑧

① Series name : HR34B Series	⑤ Number of contacts. (Excluding ground contacts)
② Shell size : Diameter(mm) of the mating interface of the plug	⑥ Contact type S : Female, wire solder SC : Female, crimp
③ Shell style WP : Straight plug WLP : Right-angle plug	
④ Conduit material and Applicable cable size A : Conduit material metal, Applicable cable (Reference) : (φ5.7~6.5) B : Conduit material metal, Applicable cable (Reference) : (φ6.5~7.3) D : Conduit material plastic, Applicable cable (Reference) : (φ5.7~6.5) E : Conduit material plastic, Applicable cable (Reference) : (φ6.5~7.3) K : Conduit material metal, Applicable cable (Reference) : (φ8.0~9.0)	⑦ Keying Blank : Standard X : X key position
	⑧ Other specifications : 2 numerical digits will be added when there is a specifications change other than shown in positions ① to ⑦

● Receptacles

HR34B - 12 WR A - 10 P - X (**)
 ① ② ③ ④ ⑤ ⑥ ⑦ ⑧

① Series name : HR34B Series	⑤ Number of contacts. (Excluding ground contacts)
② Shell size : Diameter(mm) of the mating interface of the plug	⑥ Contact type P : Male, wire solder
③ Shell style WR : Receptacle	
④ Shell type A : Square flange for 10 positions B : Square flange for 4 positions	⑦ Keying Blank : Standard X : X key position
	⑧ Other specifications : 2 numerical digits will be added when there is a specification change other than shown in positions ① to ⑦

● Crimp contacts

HR34B - SC1 - 2 1 1
 ① ② ③ ④ ⑤

① Series name : HR34B Series	④ Conductor size : 20 to 25AWG
② Contact style : SC1 : Female contact	⑤ Plating 1 : Gold plated
③ Contact type 1 : 100pcs/pack 2 : 10,000pcs/reel	

Aug.1.2019 Copyright 2019 HIROSE ELECTRIC CO., LTD. All Rights Reserved.

■ Straight plugs

● Standard type (Conduit material :Plastic)

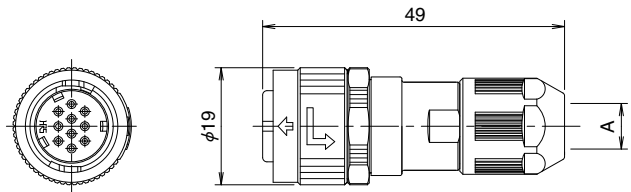

◆ Wire solder

All dimensions : mm

Part No.	HRS No.	A	Applicable cable diameter range(Reference)	Solder cup inner diameter
HR34B-12WPD-10S	134-0026-0 00	φ7.4	(φ5.7~6.5)	φ1
HR34B-12WPE-10S	134-0027-2 00	φ8.5	(φ6.5~7.3)	
HR34B-12WPD-4S	134-0020-3 00	φ7.4	(φ5.7~6.5)	φ1.7
HR34B-12WPD-4S-X	134-0023-1 00			
HR34B-12WPE-4S	134-0025-7 00	φ8.5	(φ6.5~7.3)	
HR34B-12WPE-4S-X	134-0031-0 00			

◆ Crimp (separate contacts required)

Part No.	HRS No.	A	Applicable cable diameter range(Reference)
HR34B-12WPD-10SC	134-0037-6 00	φ7.4	(φ5.7~6.5)
HR34B-12WPE-10SC	134-0038-9 00	φ8.5	(φ6.5~7.3)

● Robust type(Conduit material :Metal)

◆ Wire solder

All dimensions : mm

Part No.	HRS No.	A	Applicable cable diameter range(Reference)	Solder cup inner diameter
HR34B-12WPA-10S(71)	134-0004-7 71	φ7.4	(φ5.7~6.5)	φ1
HR34B-12WPB-10S(71)	134-0007-5 71	φ8.5	(φ6.5~7.3)	
HR34B-12WPK-10S	134-0052-0 00	φ9.5	(φ8.0~9.0)	

◆ Crimp (separate contacts required)

Part No.	HRS No.	A	Applicable cable diameter range(Reference)
HR34B-12WPA-10SC	134-0017-9 00	φ7.4	(φ5.7~6.5)
HR34B-12WPB-10SC	134-0028-5 00	φ8.5	(φ6.5~7.3)
HR34B-12WPK-10SC	134-0053-2 00	φ9.5	(φ8.0~9.0)

Not all cables of applicable dia. range can be easily assembled.

Please kindly check with factory before use.

◆ Illustrations of mated connectors.

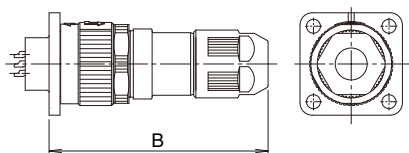

Straight plug Mating combinations	B
10 pos.plug + receptacle wire solder	50.1
4 pos.plug + receptacle wire solder	49.6

■ Right angle plugs

● Standard type (Conduit material : Plastic)

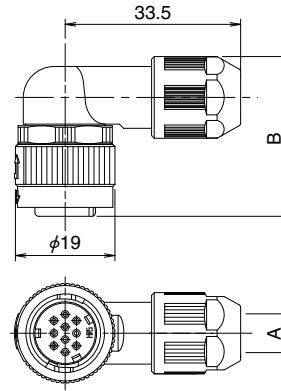
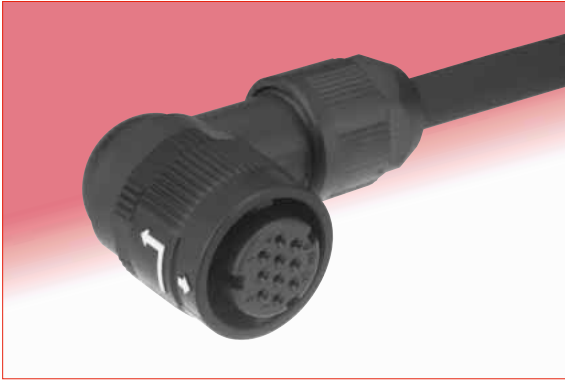

◆ Wire solder

All dimensions : mm

Part No.	HRS No.	A	B	Applicable cable diameter range(Reference)	Solder cup inner diameter
HR34B-12WLDP-10S	134-0039-1 00	φ7.4	30.85	(φ5.7~6.5)	φ1
HR34B-12WLPE-10S	134-0040-0 00	φ8.5		(φ6.5~7.3)	
HR34B-12WLDP-4S	134-0030-7 00	φ7.4		(φ5.7~6.5)	φ1.7
HR34B-12WLDP-4S-X	134-0034-8 00				
HR34B-12WLPE-4S	134-0035-0 00	φ8.5		(φ6.5~7.3)	
HR34B-12WLPE-4S-X	134-0036-3 00				

◆ Crimp (separate contacts required)

Part No.	HRS No.	A	B	Applicable cable diameter range(Reference)
HR34B-12WLDP-10SC	134-0041-3 00	φ7.4	30.85	(φ5.7~6.5)
HR34B-12WLPE-10SC	134-0042-6 00	φ8.5		(φ6.5~7.3)

● Robust type (Conduit material :Metal)

◆ Wire solder

All dimensions : mm

Part No.	HRS No.	A	B	Applicable cable diameter range(Reference)	Solder cup inner diameter
HR34B-12WLPA-10S(71)	134-0005-0 71	φ7.4	30.5	(φ5.7~6.5)	φ1
HR34B-12WLPA-10S(71)	134-0008-8 71	φ8.5		(φ6.5~7.3)	
HR34B-12WLPA-10S(71)	134-0054-5 00	φ9.5	31.5	(φ8.0~9.0)	

◆ Crimp (separate contacts required)

Part No.	HRS No.	A	B	Applicable cable diameter range(Reference)
HR34B-12WLPA-10SC	134-0018-1 00	φ7.4	30.5	(φ5.7~6.5)
HR34B-12WLPA-10SC	134-0029-8 00	φ8.5		(φ6.5~7.3)
HR34B-12WLPA-10SC	134-0055-8 00	φ9.5	31.5	(φ8.0~9.0)

Not all cables of applicable dia. range can be easily assembled.

Please kindly check with factory before use.

◆ Illustrations of mated connectors.

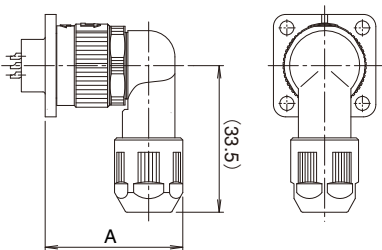

Right-angle plug Mating Combinations		A
10 pos. plug shell A,B type.	Plug + receptacle wire solder	31.0
10 pos. plug shell D,E type.	Plug + receptacle wire solder	31.3
10 pos. plug shell K type.	Plug + receptacle wire solder	32.0
4 pos. plug + receptacle wire solder		31.3

Receptacles

Wire solder

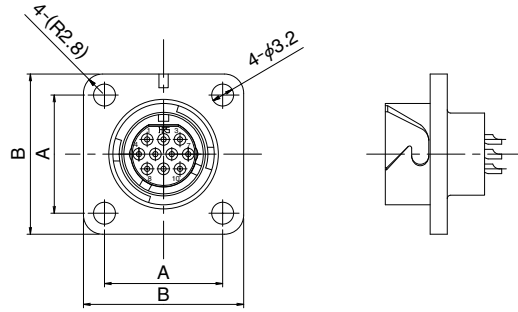
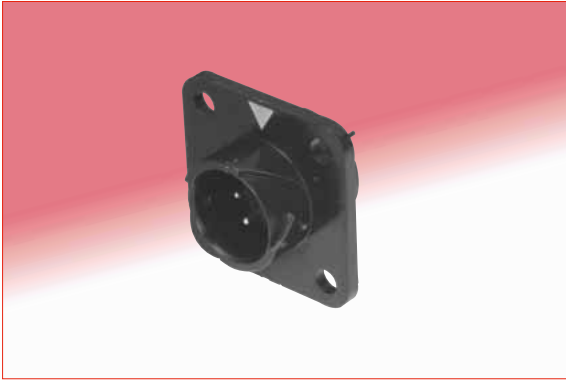

All dimensions : mm

Part No.	HRS No.	A	B	Solder cup inner diameter
HR34B-12WRA-10P	134-0016-6 00	17.26	23.4	φ1
HR34B-12WRB-4P	134-0021-6 00	18.26	25.4	φ1.4
HR34B-12WRB-4P-X	134-0024-4 00			

O ring for water proof is not attached. Please find appropriate one from the market.

Recommended panel cutouts

Receptacle - wire solder

All dimensions : mm

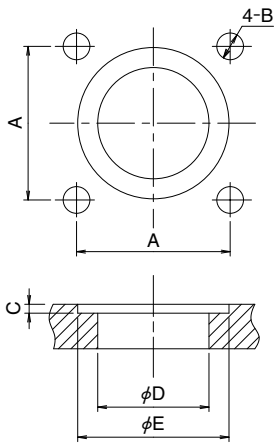

	HR34B-12WRA-10P	HR34B-12WRB-4P HR34B-12WRB-4P-X
A	17.26±0.05	18.26±0.05
B	M3×0.5	
C	1 0/-0.1	1.1 0/-0.1
D	12.5 +0.1/0	16.3 +0.1/0
E	17 +0.1/0	20.8 +0.1/0

Recommended O ring dia.

Part No.	Thickness	Inner diameter
HR34B-12WRA-10P	φ1.5	φ11.5
HR34B-12WRB-4P	φ1.5	φ15.5
HR34B-12WRB-4P-X		

Receptacle Contact Arrangement

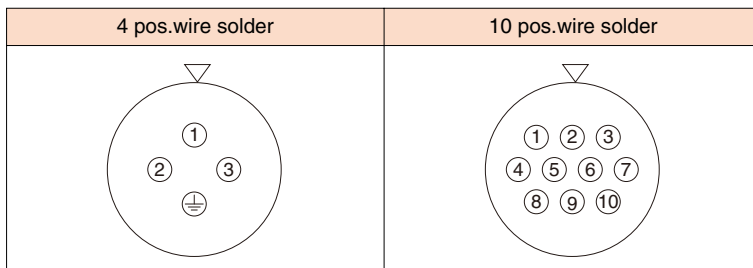

note.1 View direction : Mating surface
note.2 ⊕ mark is ground terminal.

Crimp contacts

Female

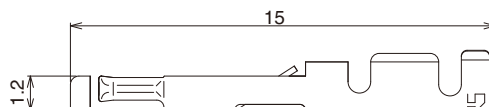

Part No.	HRS No.	Packaging	Applicable conductor
HR34B-SC1-111	134-0051-7 00	100 pcs/pack	20 to 25AWG (Stranded wire)
HR34B-SC1-211	134-0050-4 00	10,000 pcs/reel	

Note : Use wire with a jacket diameter of 1.7mm max.

◆ Connector Mating Combinations

10 pos. Plugs

Straight, Wire Solder or Crimp
 HR34B-12WPA-10S(71),10SC HR34B-12WPB-10S(71),10SC
 HR34B-12WPD-10S,10SC HR34B-12WPE-10S,10SC
 HR34B-12WPK-10S,10SC

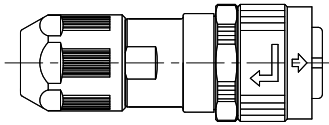

Right angle, Wire Solder or Crimp
 HR34B-12WLP A-10S(71),10SC HR34B-12WL P B-10S(71),10SC
 HR34B-12WL P D-10S,10SC HR34B-12WL P E-10S,10SC
 HR34B-12WL P K-10S,10SC

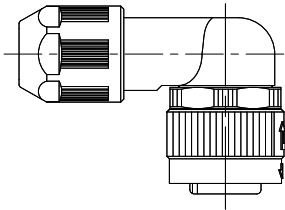

10 pos. Receptacles

Wire Solder
 HR34B-12WRA-10P

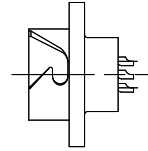

4 pos. Plugs

Straight, Wire Solder (Standard key position)
 HR34B-12WPD-4S
 HR34B-12WPE-4S

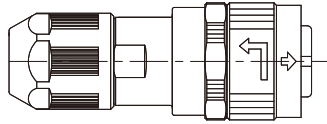

Standard key position

Right angle, Wire Solder (Standard key position)
 HR34B-12WL P D-4S
 HR34B-12WL P E-4S

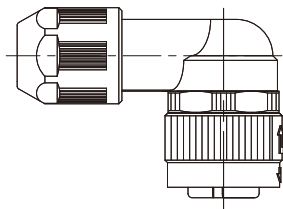

Wire solder (Standard key position)
 HR34B-12WRB-4P

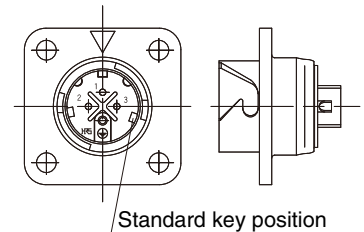

Standard key position

Straight, Wire Solder (X key position)
 HR34B-12WPD-4S-X
 HR34B-12WPE-4S-X

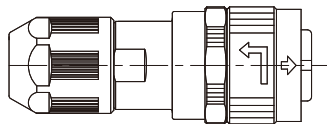

X key position

Right angle, Wire Solder (X key position)
 HR34B-12WL P D-4S-X
 HR34B-12WL P E-4S-X

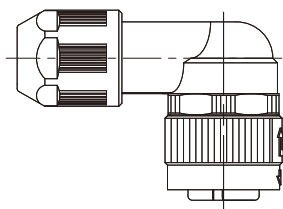

Wire solder (X key position)
 HR34B-12WRB-4P-X

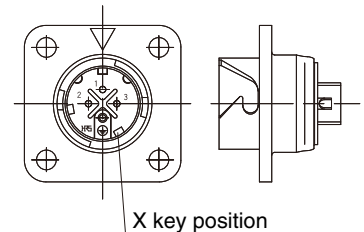

X key position

◆ Applicable tools

Description	Part No.	HRS No.	Applicable contact	Applicable cable
Manual contact crimping tool	HT304/HR34B-1	150-0107-9	HR34B-SC1-111	20AWG,23AWG,25AWG
Press	CM-105C	901-0001-0	HR34B-SC1-211	20 to 25AWG
Applicator	AP105-HR34B-1	901-2051-2		
Contact extraction tool	RP6-SC-TP	150-0039-0	HR34B-SC1-111 HR34B-SC1-211	—————

◆ Manual contact crimping tool ◆ Press CM-105C (Applicator ordered separate) ◆ Contact extraction tool



◆ Handling

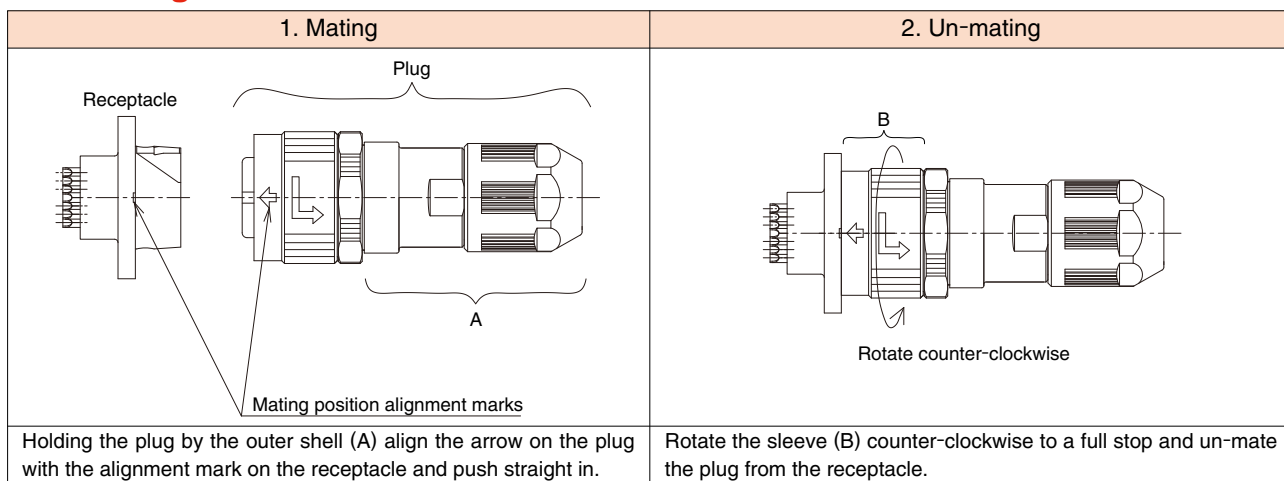

◆ Precautions

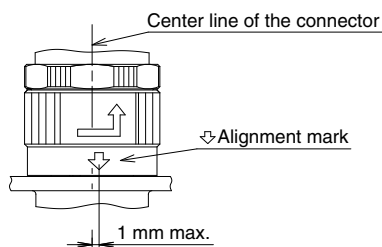

When completely mated and locked the alignment arrow on the plug must line-up with the center line of the connector (alignment mark on the receptacle).

If the alignment arrow and the center line of the connectors are not aligned (1 mm max.) re-insert the plug until they are aligned.

1. When disconnecting or inserting the connector, be sure to do so after turning off the power.
2. To insert the connector, push it in until the arrow tip of the plug mating mark indicates the specified position of the diagram below (i.e., the mating mark of the receptacle).
3. Note that the display method of the mating mark will differ depending on the receptacle.
4. To maintain the waterproof quality and cable clamp force, use a cable that is within the range of the applicable cable diameter.
5. Please consult Hirose Electric Sales for harness assembly procedure.



HIROSE ELECTRIC CO.,LTD.

2-6-3,Nakagawa Chuoh,Tsuzuki-Ku,Yokohama-Shi 224-8540,JAPAN
 TEL: +81-45-620-3526 Fax: +81-45-591-3726
<http://www.hirose.com>
<http://www.hirose-connectors.com>