

Interface Connectors for Factory Automation Network

HR31 Series

Complies with DeviceNet requirements

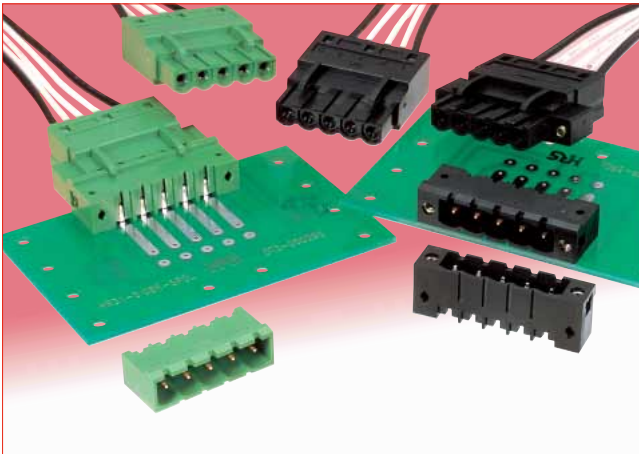

Comparison of plug heights

● Hirose HR31

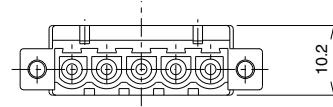

● Other manufacturer's product

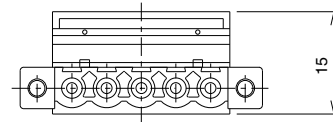

■ Features

1. DeviceNet Compliant

Conforms to requirements of Factory Automation Network DeviceNet standards. Hirose products are distinct from products of made others, as described below.

Feature	Made by others	Hirose HR31
Reduced number of termination operations	Crimped to commercially available cap connectors, inserted into housing and fastened by screw. (*)	Crimped and connected to terminal then fastened simply by inserting into housing.
High density mounting	Plug height : 15 mm	Plug height is 10.2 mm, allowing use of less space when mounting several connectors
Prevention of connection errors	Contact positions not identified.	Permanently identified contact positions
Number of required operations to secure receptacle assembly to the board	Connectors are attached by screws from the opposite side.	No need for screws, built-in locking pin secures connector to the board

*Although it is possible to terminate discrete cables with screws and not use a pin contact, however, there is the potential issue and concern for long-term reliability and problems. Therefore, most users prefer to use crimp contacts.

2. Screw-lock style

The screw lock style connector features secure mating and a higher locking force retention.

3. Snap-lock Style

The snap lock plug features a structure that creates a tactile click during mating.

4. Commercially available tools may be used

Use crimp tools conforming to JIS C 9711 standards. Terminated contacts can be removed using 1 mm dia. steel pin. and re-inserted.

5. Protected contacts

When installed, the crimped contacts are protected completely by the plug housing. This design eliminates the risk of damaging the contacts.

Total space occupied by mated assemblies

With screw lock

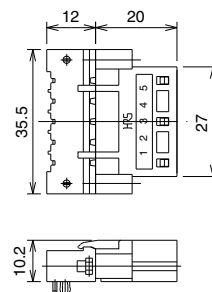

■ Product Specification

Rating	Current rating	12A (2.5mm ² wire) 10A (1.5mm ² wire)	Operating temperature range	-40°C to +100°C
	Voltage rating	250V AC, 350V DC	Storage temperature range	-40°C to +85°C
Item		Specification	Conditions	
1.Contact resistance		5 mΩ max.	1A DC	
2.Insulation resistance		1000 MΩ min.	500 V DC	
3.Withstanding voltage		No flashover or insulation breakdown	2000V AC/one minute	
4.Impulse withstanding voltage		No flashover or insulation breakdown	Standard waveform of 4KV, positive/negative, 3 times each	
5.Vibration		No electrical discontinuity of 10 μs or more	Frequency: 10 to 55 Hz, single amplitude of 0.75 mm, 5 min. in each of the 3 directions, 10 cycles each	
6.Durability (insertion/ withdrawal)		Contact resistance: 10 mΩ max.	1000 cycles	
7.Temperature cycle		Insulation resistance: 1000 MΩ min.	Temperature: -40°C / Room temperature to +100°C / Room temperature Time: 30 / 10 to 15 / 30 / 10 to 15 (Minutes) 5 cycles	
8.Humidity		Insulation resistance: 10 MΩ min. (Humidity state) 100 MΩ min. (Dry state)	96 hours at temperature of 40°C and humidity of 90% to 95%	

■ Materials

Part		Material	Finish	Remarks
Plug	Insulator	PBT	Color: Black or Green	UL94V-0
	Screw	Steel	Nickel plating	—
Crimp contact	Socket contact	Contact area: phosphor bronze Termination area: copper	Contact area: gold plating Termination area: tin plating	—
Receptacle	Insulator	PBT	Color: Black or Green	UL94V-0
	Male contact	Brass	Contact area: gold plating Termination are: gold plating	—
	Nut	Steel	Nickel plating	—
	Board retention pin	Phosphor bronze	Tin plating	Board retention pin

■ Ordering information

● Connector

HR31 - 5.08 P A - 5 S C (01)

① Model name	HR31	⑦ Terminal type C: Crimping DL: Right angle through hole type D: Straight through hole type
② Contact pitch	5.08mm	
③ Connector type	P: Plug R: Receptacle	⑧ Other specifications: A two-digit number such as (01) or (02) is added to indicate other specifications.
④ Screw lock type	Blank: With screw A: Without screw	
⑤ Number of contacts	5	
⑥ Contact type	S: Female contact P: Male contact	

● Crimp contact

HR31 - SC - 1 1 1 (01)

⑨ Model name	HR31	⑬ Plating type 1: Gold plating
⑩ Contact type	SC: female contact	
⑪ Contact packaging type	1: loose contact	⑭ Other specifications: A two-digit number such as (01) or (02) is added to indicate other specifications.
⑫ Conductor cross area	1: 1.04 to 2.63mm ² 2: 0.2 to 1.65mm ²	

■ Plug (with screw lock)



HR31-5.08P-5SC

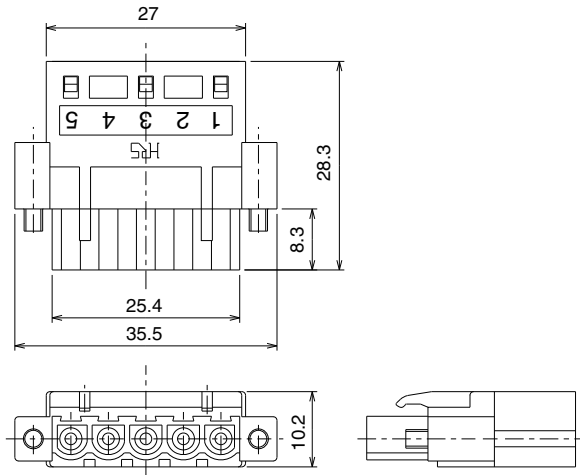

Part No.	HRS No.	Weight	Color
HR31-5.08P-5SC(72)	131-0002-2 72	8g	Green

◆ Crimp contact

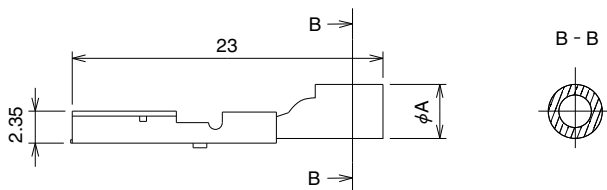

Part No.	HRS No.	φA	Weight	Contact plating	Applicable conductor cross area (Note 2)
HR31-SC-111(71)	131-0004-8 71	4	1g	Gold	1.04 to 2.63mm ²
HR31-SC-121(71)	131-0005-0 71	3.3			0.2 to 1.65mm ²

Note 1: Packaging (100 pcs/pack)

Note 2: For a multi-strand conductors

■ Receptacle (Right angle through hole type with screw lock)



HR31-5.08R-5PDL

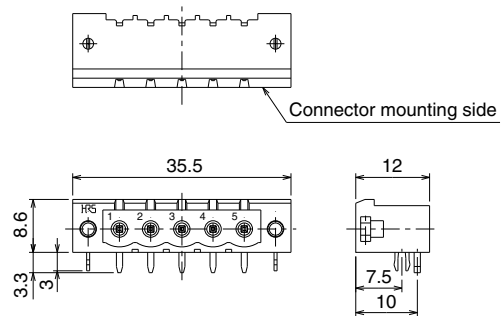

Part No.	HRS No.	Weight	Color	Contact plating	Board retention pin
HR31-5.08R-5PDL(72)	131-0001-0 72	4g	Black	Gold	With
HR31-5.08R-5PDL(75)	131-0001-0 75		Green		

◆ PCB mounting pattern

● With screw lock

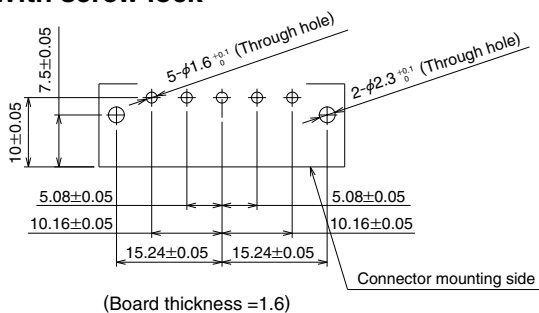

Oct. 1. 2019 Copyright 2019 HIROSE ELECTRIC CO., LTD. All Rights Reserved.

■ Receptacle (Straight through hole type with screw lock)

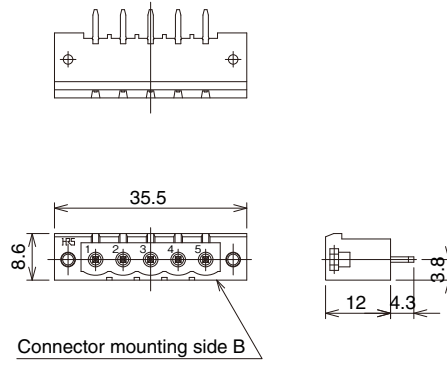

Part No.	HRS No.	Weight	Color	Contact plating	Board retention pin
HR31-5.08R-5PD(76)	131-0003-5 76	4g	Green	Gold	Without

◆ PCB mounting pattern

● With screw lock

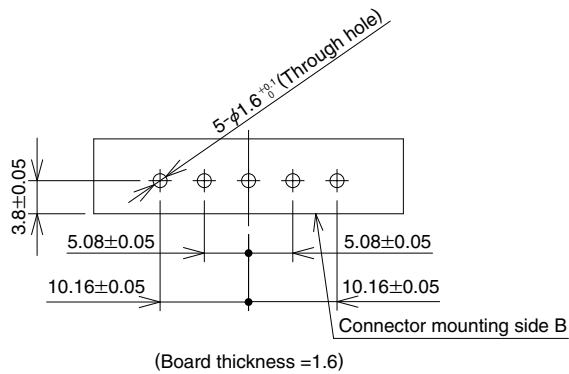

◆ **Tools**

Type	Part No.	HRS No.
Manual crimp tool	HR31-TC-01	902-1512-4
Contact removal pin	HR31-SC-TP	150-0215-1

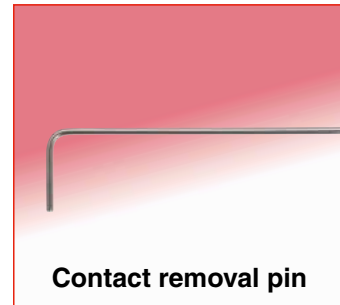

● **Tools application procedures**

1. Manual contact crimp tool

The tool will terminate all specified crimp contacts. Placement of correct contact in corresponding crimp position on the tool is critical. The positions are clearly indicated on the tool as (2) and (1.25). The exposed conductor strip length is 5mm.

Crimp position indicator	Applicable crimp contact
2	HR31-SC-111
1.25	HR31-SC-121

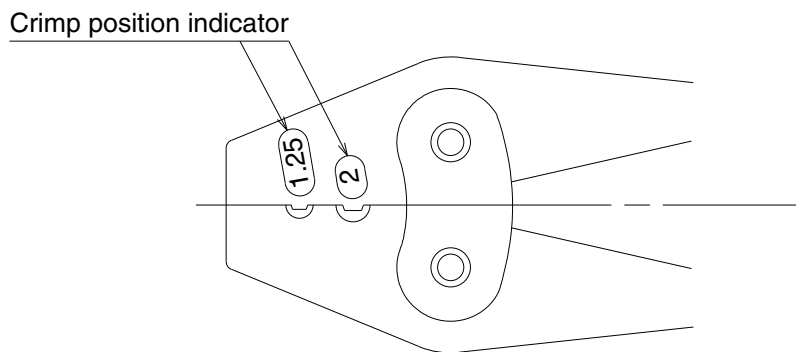

2. Contact removal/extraction

Wiring errors can be corrected by removing the crimp contacts using the extraction tool and the following procedure.

- 1) Insert the extraction tool from the underside of connector and apply pressure onto the mold lance. (Fig.1)
- 2) While pressing on the mold lance, angle the extraction tool and release the disconnection prevention mechanism on the crimping contact. (Fig.2)
- 3) Remove the extraction tool.
- 4) Pull the wire rearward to disconnect and remove the contact.

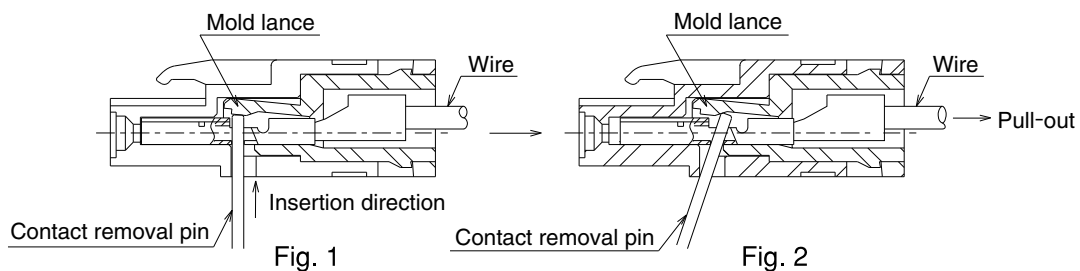

◆ Usage Precautions

1. To prevent damage, align receptacle with the panel and board in such a way that it is not subject to excess loads.

1.1 Recommended mounting panel dimensions (right angle through hole type)

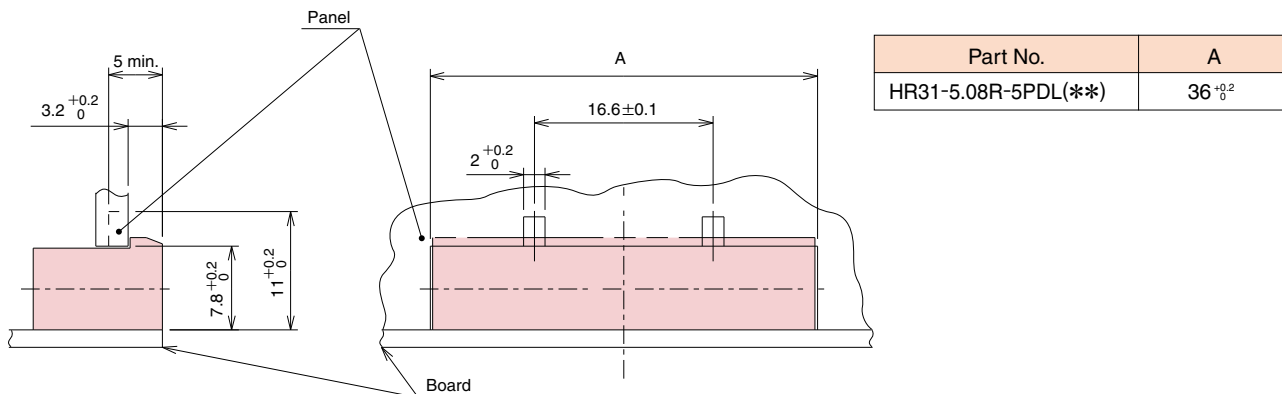

1.2 Recommended mounting panel dimensions (straight through hole type)

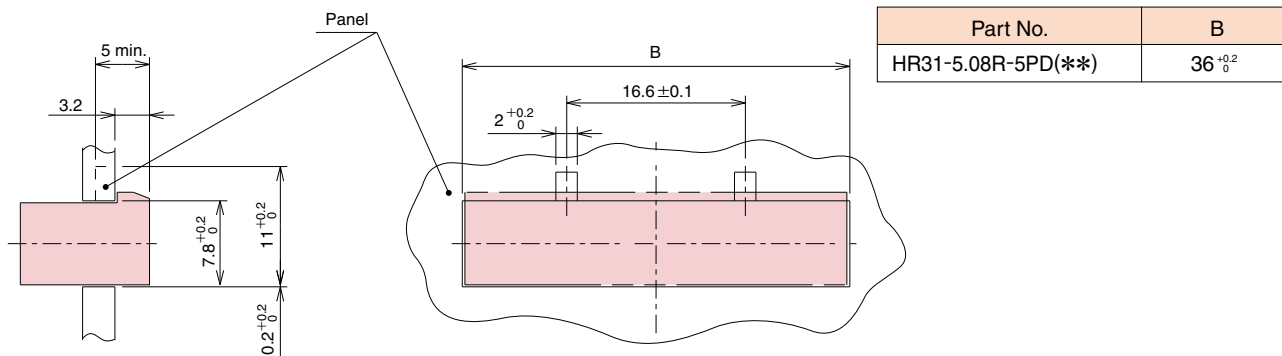

2. Insert the crimp contact into the plug in the direction shown below.

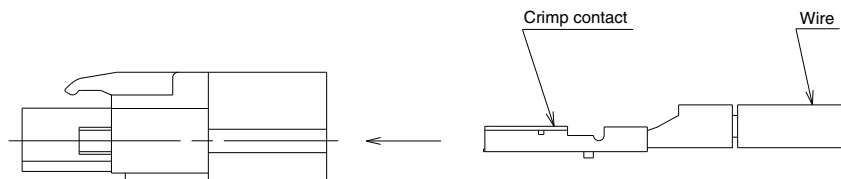

3. Use a number 0 cross drive bit to tighten the screw lock's screw.

4. Assure that the circuit's power is off when mating and un-mating connectors.



HIROSE ELECTRIC CO.,LTD.

2-6-3,Nakagawa Chuoh,Tsuzuki-Ku,Yokohama-Shi 224-8540,JAPAN

TEL: +81-45-620-3526 Fax: +81-45-591-3726

<http://www.hirose.com>

<http://www.hirose-connectors.com>