

Micro-USB connectors meeting USB 2.0 Standard

ZX Series

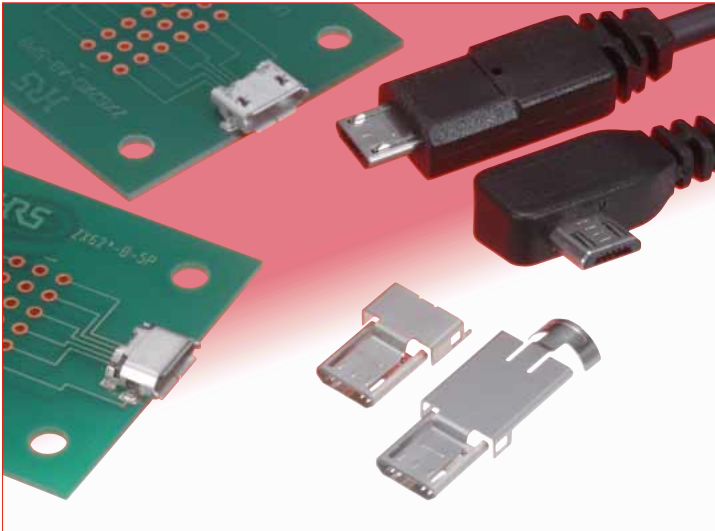

Note : Contact us to ascertain whether a TID number has been acquired for an individual product.

Fig.1

Overview

Extremely small highly reliable connectors complying with physical, electrical and environmental requirements of Micro-USB standard (USB 2.0). Receptacles and plugs are available in a wide variety of mounting and termination styles, allowing their use in various applications.

Features

1. Size reduction

Compared with the standard Mini-USB connectors, the size of ZX connectors is reduced by approximately 60% while still allowing a high-speed data transfer of 480 Mbps, specified in USB 2.0.

2. Receptacle styles

Two interface configurations: Micro-B and Micro-AB in standard, mid-mount and reverse mounting styles. SMT and through-hole (shell) PC board terminations.

3. Plug styles

Corresponding to the receptacle styles, two interface configurations: Micro-A and Micro-B, with direct wire or PCB wire soldering. Several plug styles can be used for data transmission, earphone or charging applications.

4. Smooth mating and unmating

A smooth mating and unmating operation results in less wear and a longer product life. The unique Hirose active latch mechanism produces a reliable and durable connector.

Even after repeated use, the user will experience a smooth click sensation when mating the connectors.

Note : The statement above only applies when using both plug and receptacles made by Hirose Electric.

5. Hirose was the first company to obtain a Micro-USB certification (TID number).

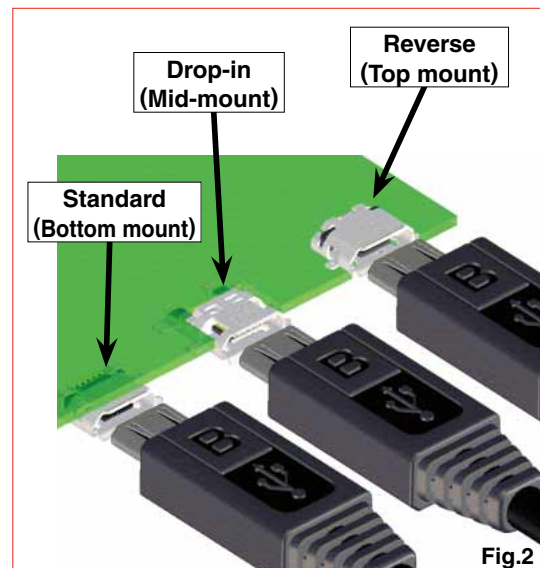

Fig.2

USB 2.0 Hi-Speed (480 Mbps)

Eye diagram measurement results :
Measured with 2.4 m long USB 2.0 cable

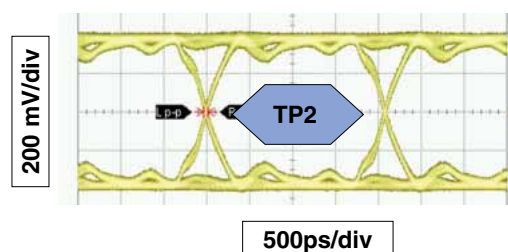

Fig.3

Product Specifications

Ratings	Current rating	1A (per contact) or 1.8A (contacts No. 1 and 5) and 0.5A (contacts No. 2, 3, and 4)	Voltage rating	30V AC
			Operating temperature range	-30°C to +85°C (Note1)
			Storage temperature range	-30°C to +60°C

Item	Specification	Conditions
1. Contact resistance	30mΩ max.	100mA
2. Withstanding voltage	No flashover or insulation breakdown	100V AC / 1 minute
3. Capacitance	2pF max.	Between adjacent contacts at 1,000Hz (AC voltage)
4. Durability	Contact resistance : Rise from initial value of 10mΩ max.	10,000 cycles
5. Total insertion/removal force	Insertion force : 35N max., Removal force : 8N min.	Mated with corresponding connector

Note1 : Includes temperature rise caused by current flow.

Note2 : Information contained in this catalog represents general requirements for this Series. Contact us for the drawings and specifications for a specific part number shown.

Materials / Finish

Receptacles

Part	Material	Finish	Remarks
Insulator	LCP	Micro-B: Black, Micro-AB: Gray	UL94V-0
Contacts	Copper alloy	Selective gold plated	————
Shell	Stainless steel	Tin alloy plating	————

Plugs

Part	Material	Finish	Remarks
Insulator	LCP	Micro-B: Black, Micro-AB: Gray	UL94V-0
Contacts	Copper alloy	Selective gold plated	————
Shell	Stainless steel	Tin alloy plating	————

Product Number Structure

Refer to the chart below when determining the product specifications from the product number.

Please select from the product numbers listed in this catalog when placing orders.

Receptacles

ZX 62 RD - B - 5 P * 8
① ② ③ ④ ⑤ ⑥ ⑦ ⑧

Plugs

ZX 40 - B - 5 S * - UNIT
① ② ④ ⑤ ⑥ ⑦ ⑨

ZX 40 - B - SLDA
① ② ④ ⑨

① Series name	ZX
② Termination style	10's : Right-angle PCB wire, SMT 20's : Straight, PCB wire 40's : Direct wire 60's : Right-angle, PCB wire 80's : Cradle SMT
③ Board mounting style (Receptacles)	Blank Standard (Bottom mount) D Standard (Bottom mount) through hole R Reverse (Top mount) RD Reverse (Top mount) through hole M Drop-in (Mid-mount)
④ Mating side configuration	A Micro-A B Micro-B AB Micro-AB
⑤ Number of contacts	5
⑥ Contact type	P Receptacle- Male S Plug – Female
⑦ Serial No.	
⑧ Shell termination style – Blank Receptacles	SMT 8 Through hole (solder tab length: 0.8mm)
⑨ Components-plugs	UNIT Assembly (Insulator/contact/lock) Cover (Note 1)

Note 1 : Classifiers such as A, B, and C are entered for *.

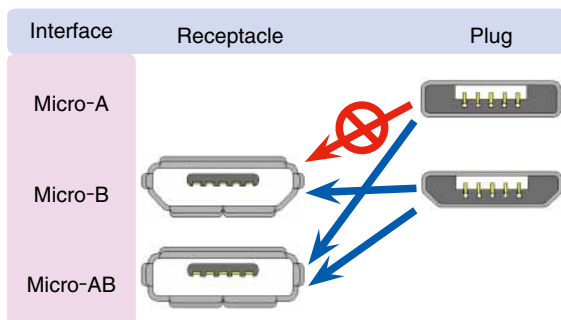

■ Configurations

	Mating side configuration	Type	Part No.	3D Image	Page	
R e c e p t a c l e s	Micro-B	Standard	SMT	ZX62-B-5PA(33)		4
			SMT + DIP	ZX62D-B-5PA8(30)		4
		Reverse	SMT	ZX62R-B-5P(30)		5
		Drop-in	SMT	ZX62M-B-5P(30)		5
	Micro-AB	Standard	SMT	ZX62-AB-5PA(31)		6
			SMT + DIP	ZX62D-AB-5P8(30)		6
		Reverse	SMT	ZX62R-AB-5P(30)		7
			SMT + DIP	ZX62RD-AB-5P8(30)		7
	P l u g s	Micro-B	Direct wire soldering	Assembly (insulator/contacts/lock) : ZX40-B-5S-UNIT(31) Cover-top : ZX40-B-SLDA Cover-bottom : ZX40-SLDB		9 and 10
			PCB wire soldering (straight, through hole)	Assembly (insulator/contacts/lock) : ZX20-B-5S-UNIT(30) Cover : ZX20-B-SLDC		11
PCB wire soldering (SMT)			Assembly (insulator/contacts/lock) : ZX64-B-5S-UNIT(31) Cover-top : ZX64-B-SLDA Cover-bottom : ZX64-SLDB		12 and 13	
PCB wire soldering (SMT)			Assembly (insulator/contacts/lock) : ZX64-B-5S-UNIT(31) Cover : ZX64-B-SLDC		12 and 13	
Micro-A		Direct wire soldering	Assembly (insulator/contacts/lock) : ZX40-A-5S-UNIT(30) Cover-top : ZX40-A-SLDA Cover-bottom : ZX40-SLDB		14 and 15	
C r a d l e s	Micro-B	SMT + DIP	ZX80-B-5S(30)	With lock	16	
			ZX80-B-5SA(30)	Without lock	16	

Note : 1 Part numbers in the Plugs section of the above table list the Assembly (insulator/contacts/locks) and the corresponding Shields/Covers.
 Note : 2 Optional Printed Circuit boards for the Plugs are shown for reference only. Not supplied with applicable connectors.
 Note : 3 The color of the insulators body in the Assembly (insulator/contacts/lock) shown in the 3D Image column above is blue for clarity. Refer to the Materials (Page 2) for correct colors.

■ Receptacles

● Micro B - Standard (Bottom mount), Shell SMT

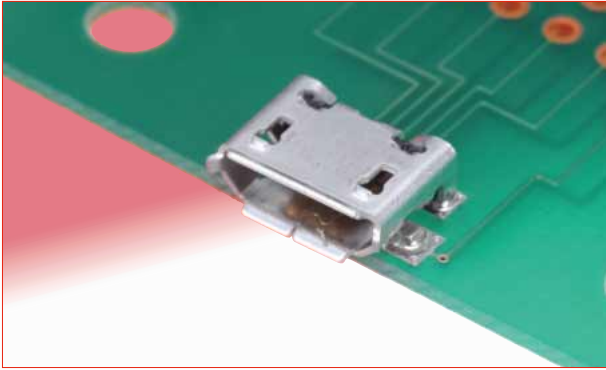

Part No.	HRS No.	Packaging
ZX62-B-5PA(33)	242-0033-8 33	3,500pcs/reel

◆ Recommended PCB mounting pattern

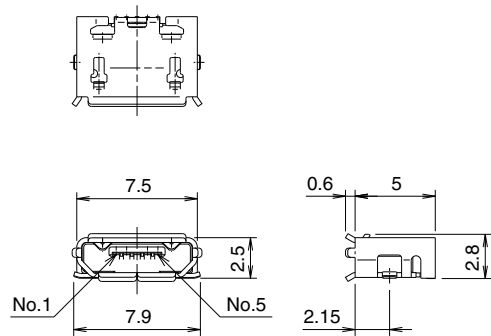
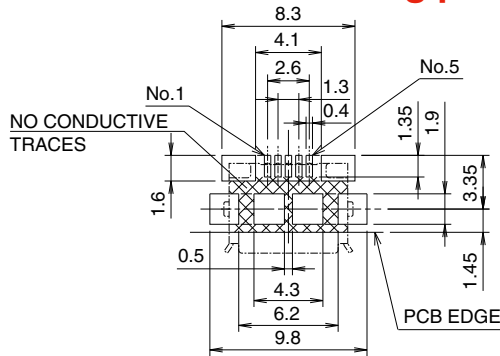

All dimensions : mm

● Micro B - Standard (Bottom mount), Shell through hole

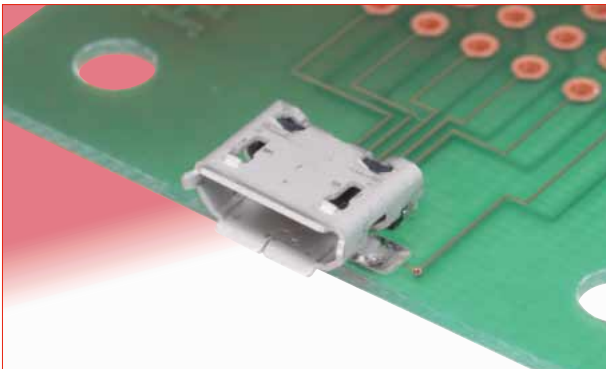

Part No.	HRS No.	Packaging
ZX62D-B-5PA8(30)	242-0056-3 30	2,000pcs/reel

◆ Recommended PCB mounting pattern

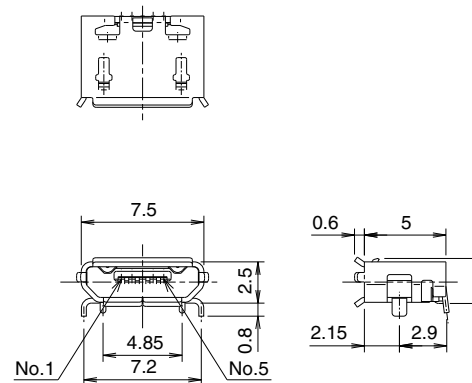
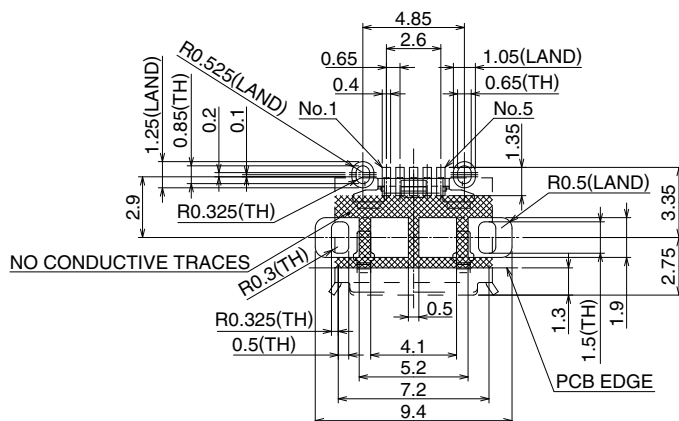

All dimensions : mm

■ Receptacles

● Micro AB - Standard (Bottom mount), Shell SMT

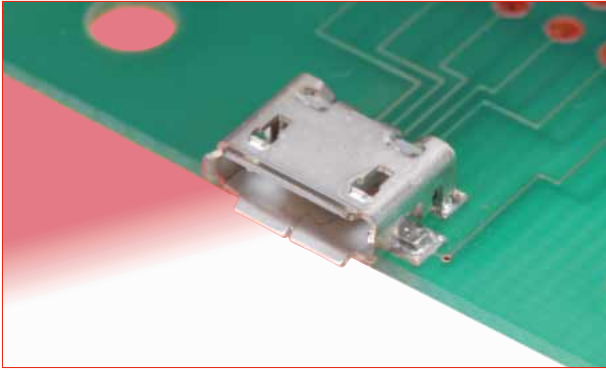

Part No.	HRS No.	Packaging
ZX62-AB-5PA(31)	242-0045-7 31	3,500pcs/reel

◆ Recommended PCB mounting pattern

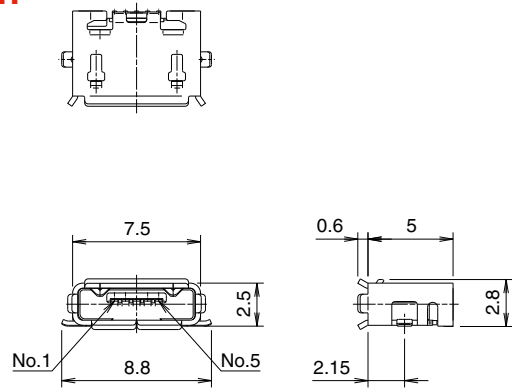
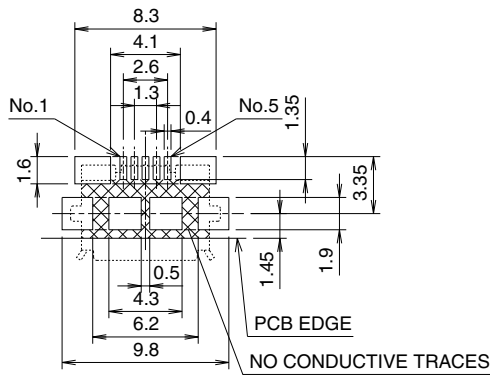

All dimensions : mm

● Micro AB - Standard (Bottom mount), Shell through hole

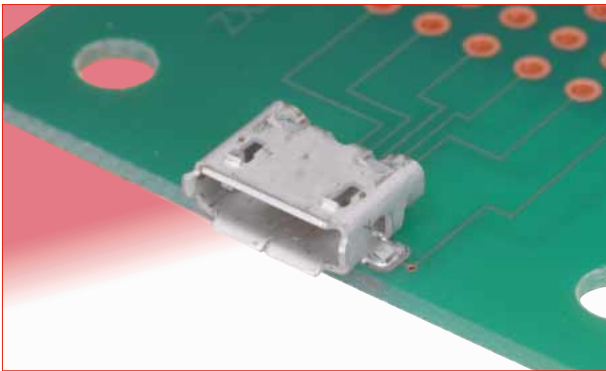





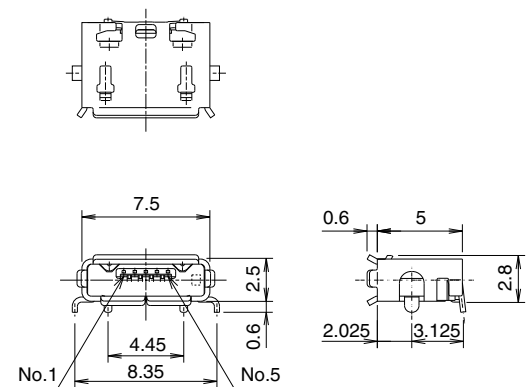
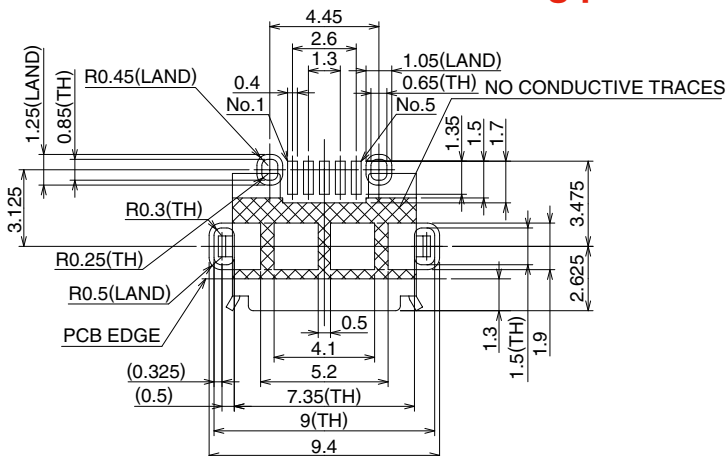

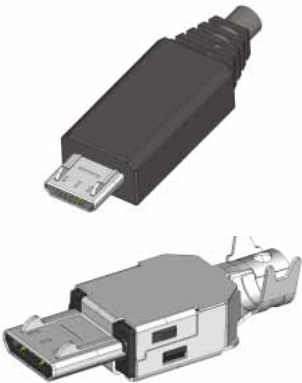
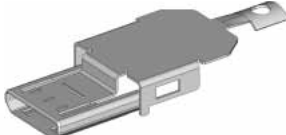

Part No.	HRS No.	Packaging
ZX62D-AB-5P8(30)	242-0027-5 30	2,000pcs/reel

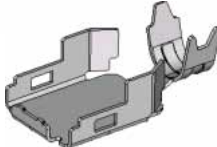
◆ Recommended PCB mounting pattern

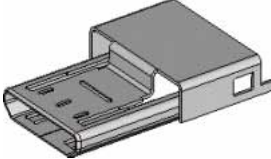

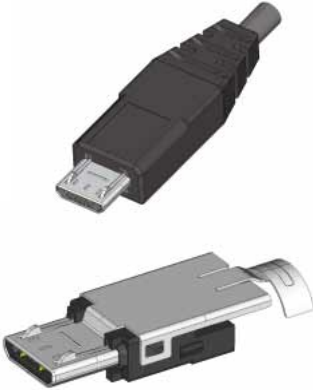
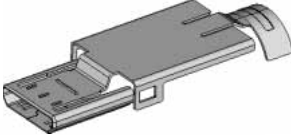
All dimensions : mm

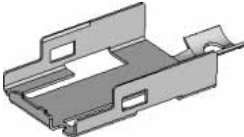
Plugs – assembled (not-terminated, without overmold)	Components
<p data-bbox="240 197 695 232">ZX40 - Direct wire soldering</p> 	 <p data-bbox="1177 271 1414 306">ZX40-*SLDA</p> <p data-bbox="1177 311 1267 333">Cover-top</p>  <p data-bbox="1177 400 1414 436">ZX40-*5S-UNIT</p> <p data-bbox="1177 441 1366 508">Assembly (insulator/ contacts/lock) *No PCB required</p>  <p data-bbox="1177 544 1414 580">ZX40-SLDB</p> <p data-bbox="1177 584 1302 607">Cover-bottom</p>
<p data-bbox="240 674 695 710">ZX20 - PCB wire soldering</p> 	 <p data-bbox="1177 768 1414 804">ZX20-*SLDC</p> <p data-bbox="1177 808 1235 831">Cover</p>  <p data-bbox="1177 916 1414 952">ZX20-*5S-UNIT</p> <p data-bbox="1177 956 1414 1046">Assembly (insulator/ contacts/lock) *Vertical through hole PCB termination</p>
<p data-bbox="240 1081 695 1117">ZX64 - PCB wire soldering</p> 	 <p data-bbox="1177 1153 1414 1189">ZX64-*SLDA</p> <p data-bbox="1177 1193 1267 1216">Cover-top</p>  <p data-bbox="1177 1283 1414 1319">ZX64-*5S-UNIT</p> <p data-bbox="1177 1323 1414 1413">Assembly (insulator/ contacts/lock) *Right angle through hole PCB termination</p>  <p data-bbox="1177 1471 1414 1507">ZX64-SLDB</p> <p data-bbox="1177 1512 1302 1534">Cover-bottom</p>

Feb. 1. 2025 Copyright 2025 HIROSE ELECTRIC CO., LTD. All Rights Reserved.

■ Plugs

● Micro B - Assembly (insulator/contacts/lock) – Direct wire soldering



Part No.	HRS No.	Packaging
ZX40-B-5S-UNIT(31)	242-0002-4 31	1 piece

Contact HRS for Cable Termination Procedure Manual.

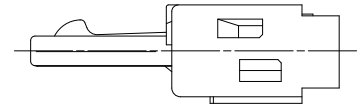
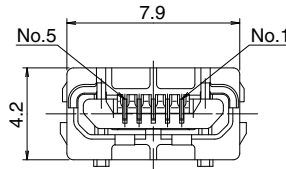
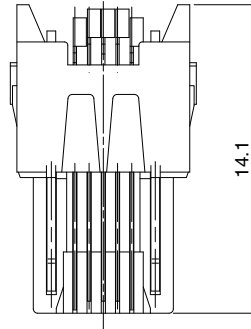
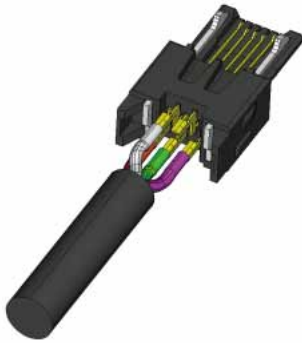

All dimensions : mm

● Micro B - Component, Cover-top - Direct wire soldering

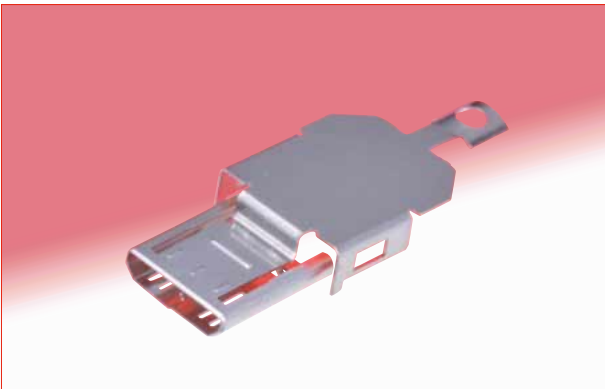

Part No.	HRS No.	Packaging
ZX40-B-SLDA	242-0003-7	4,000pcs/reel

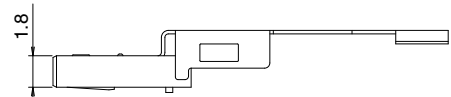
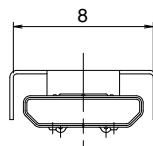
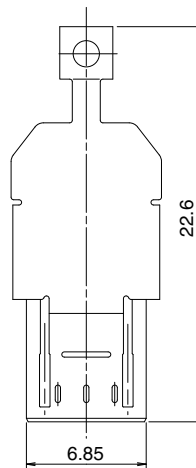

All dimensions : mm

■ Plugs

● Micro A, Micro B - Component, Cover-bottom - Direct wire soldering

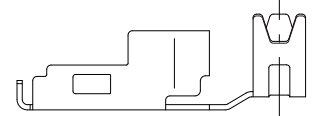
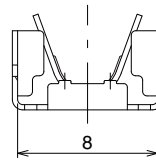
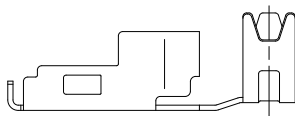
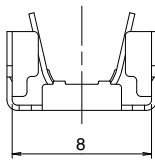
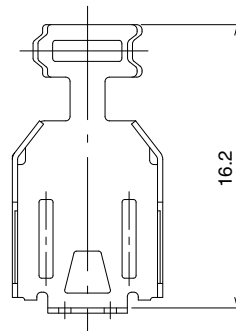
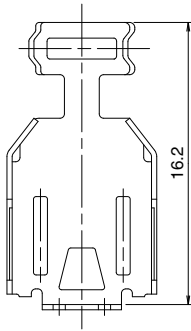
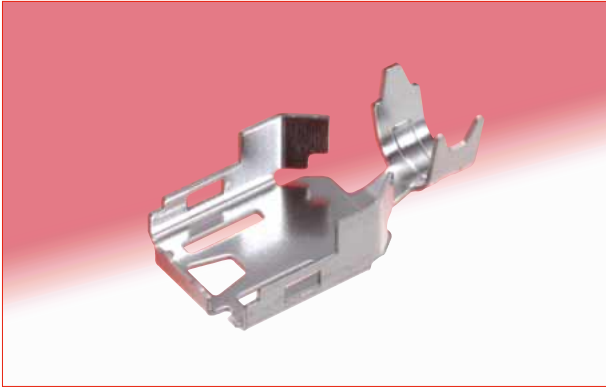

All dimensions : mm

ZX40-SLDB

ZX40-SLDB(3.3)

Part No.	HRS No.	Packaging	Cable dia.
ZX40-SLDB	242-0004-0	4,000pcs/reel	φ3.8
ZX40-SLDB(3.3)	242-0023-4		φ3.3

● Assembled

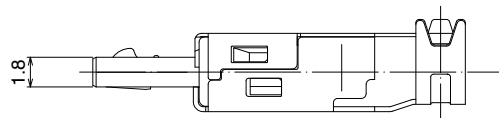
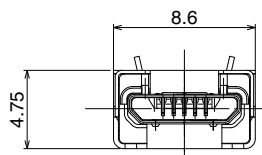
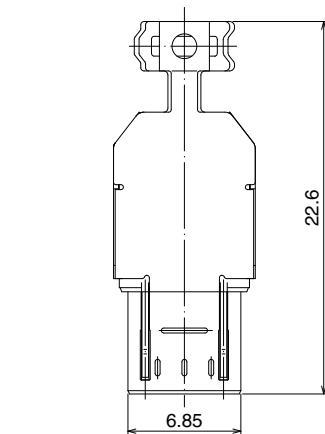

All dimensions : mm

Plugs

● Micro B - Assembly (insulator/contacts/lock) - Vertical through hole PCB wire soldering (non-direct)

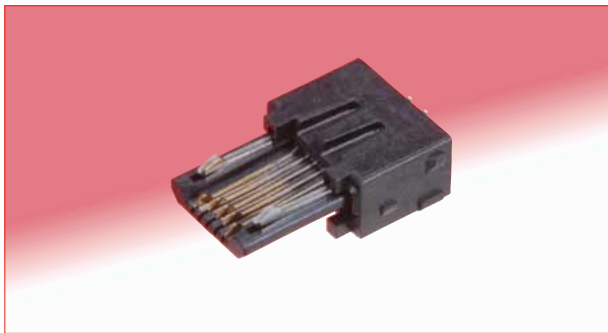

Part No.	HRS No.	Packaging
ZX20-B-5S-UNIT(30)	242-0012-8 30	4,000pcs/pks

Contact HRS for Cable Termination Procedure Manual.

PCB mounting pattern

*PCB required (not supplied)
Max. thickness: 0.6mm

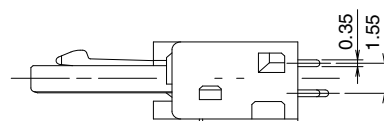
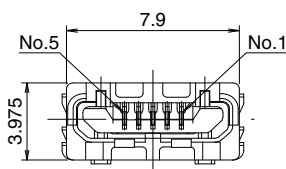
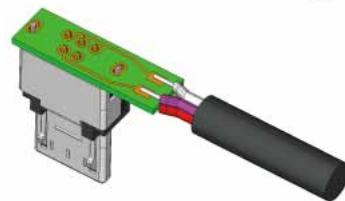
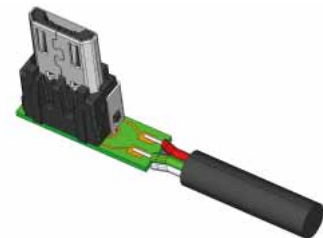
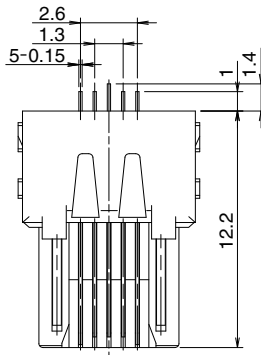
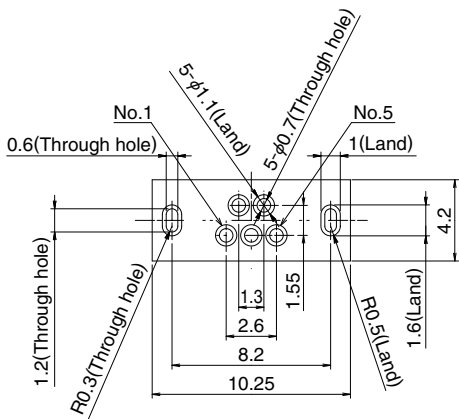

All dimensions : mm

● Micro B - Component, Cover - through hole

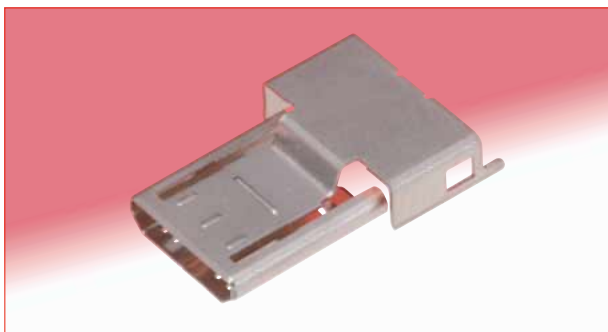

Part No.	HRS No.	Packaging
ZX20-B-SLDC	242-0022-1	4,000pcs/reel

● Assembled

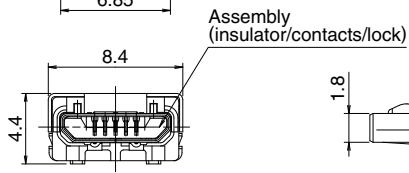
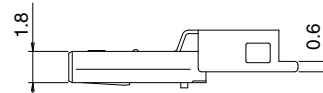
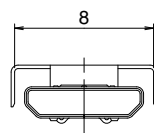
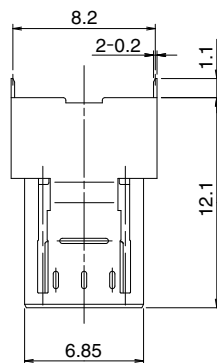
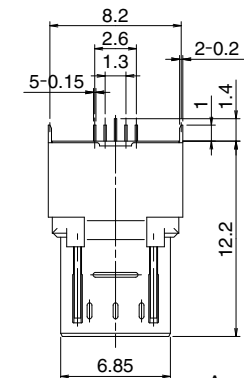

All dimensions : mm

■ Plugs

● Micro B - Assembly (insulator/contacts/lock) - Right angle SMT

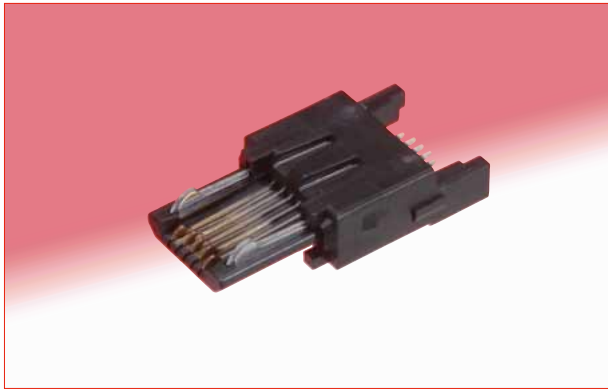

Part No.	HRS No.	Packaging
ZX64-B-5S-UNIT(31)	242-0009-3 31	1 piece

Contact HRS for Cable Termination Procedure Manual.

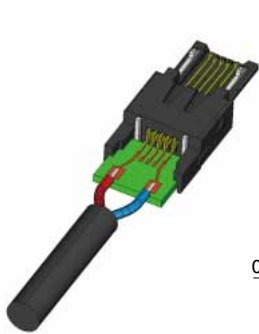

PCB mounting pattern
*PCB required (not supplied)
Max. thickness: 1.0mm

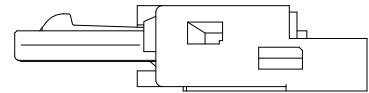
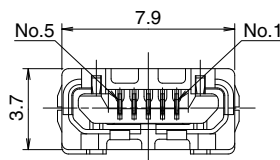
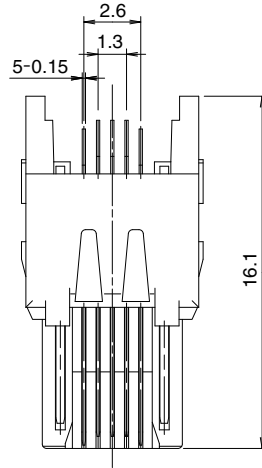
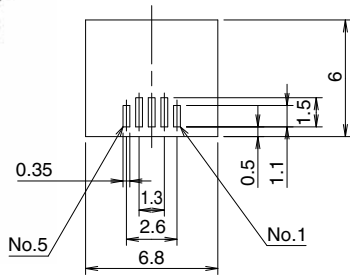

All dimensions : mm

● Micro B - Component, Cover-top – Right angle SMT

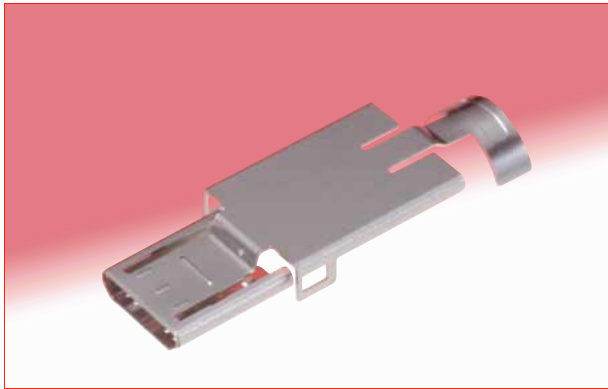

Part No.	HRS No.	Packaging
ZX64-B-SLDA	242-0013-0	4,000pcs/reel

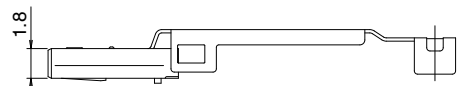
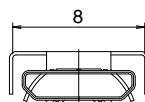
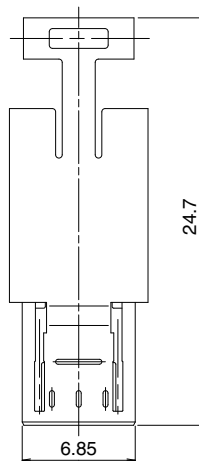

All dimensions : mm

Plugs

● Micro B - Component, Cover-bottom - Right angle SMT

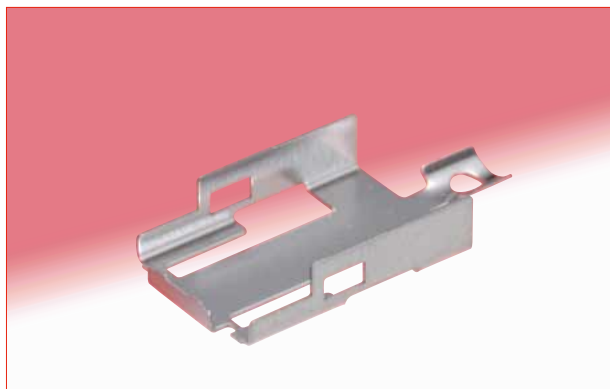

Part No.	HRS No.	Packaging
ZX64-SLDB	242-0049-8	4,000pcs/reel

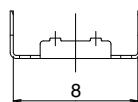
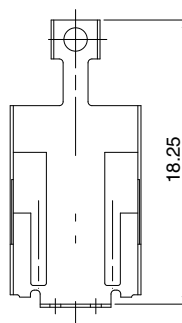

● Assembled

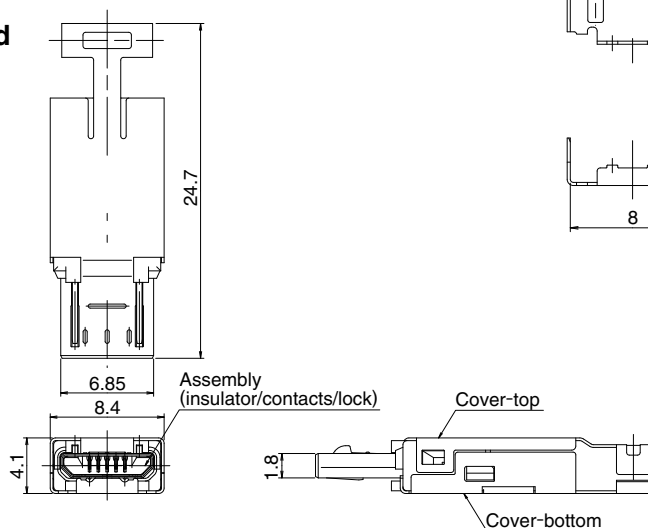

All dimensions : mm

● Micro B - Component, Shell/cover – Right angle SMT



Part No.	HRS No.	Packaging
ZX64-B-SLDC	242-0018-4	4,000pcs/reel

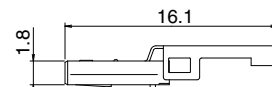
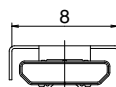
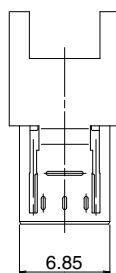

Shell/cover, without cable clamp
This shell/cover does not require ZX64-SLDB.

● Assembled

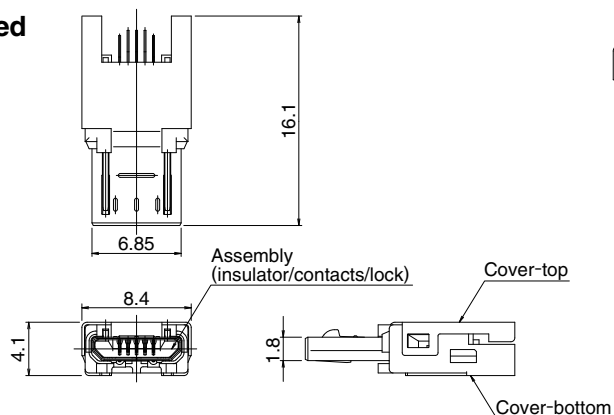

All dimensions : mm

Plugs

● Micro A - Assembly (insulator/contacts/lock) - Direct wire soldering

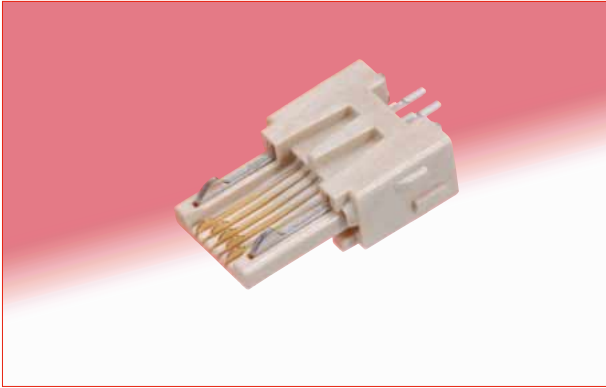

Part No.	HRS No.	Packaging
ZX40-A-5S-UNIT(30)	242-0010-2 30	1 piece

Contact HRS for Cable Termination Procedure Manual.

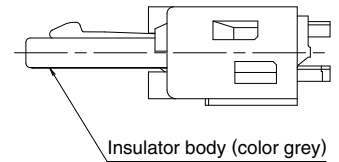
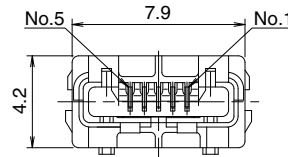
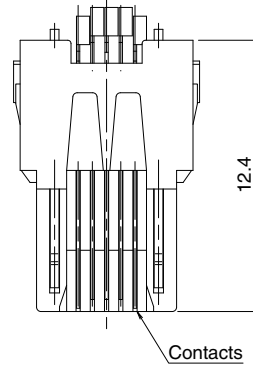
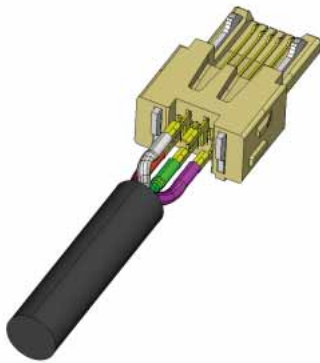

All dimensions : mm

● Micro A - Component, Cover-top - Direct wire soldering

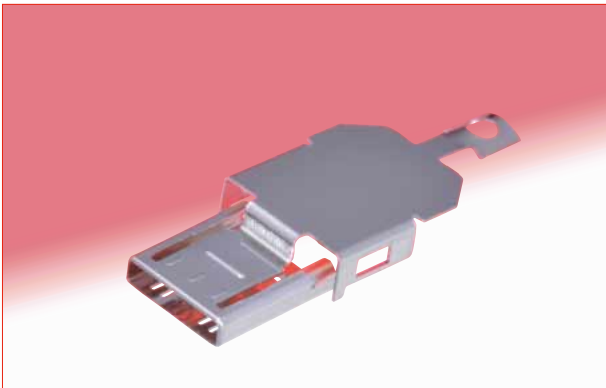

Part No.	HRS No.	Packaging
ZX40-A-SLDA	242-0011-5	4,000pcs/reel

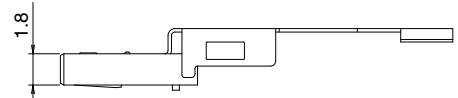
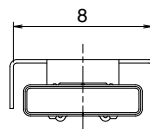
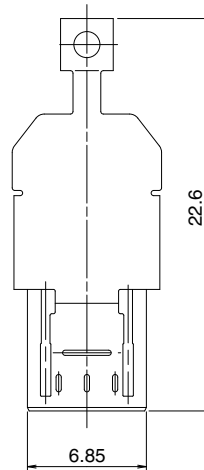

All dimensions : mm

Plugs

● Micro A, Micro B - Component, Cover-bottom - Direct wire soldering

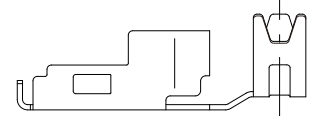
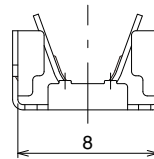
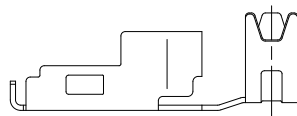
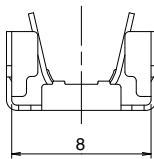
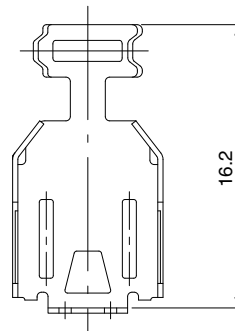
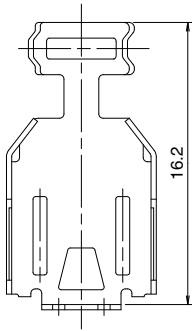
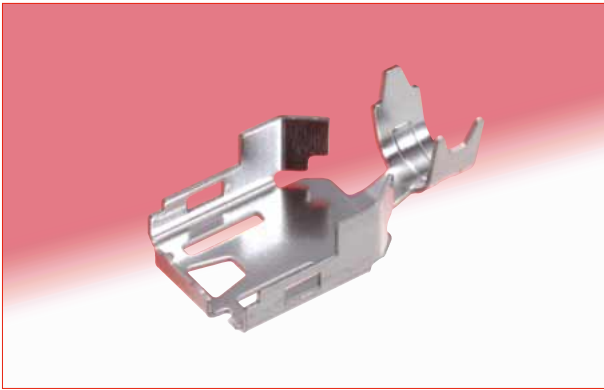

ZX40-SLDB

ZX40-SLDB(3.3)

All dimensions : mm

Part No.	HRS No.	Packaging	Cable dia.
ZX40-SLDB	242-0004-0	4,000pcs/reel	φ3.8
ZX40-SLDB(3.3)	242-0023-4		φ3.3

● Assembled

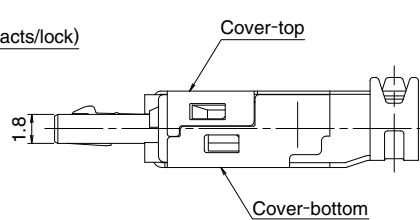
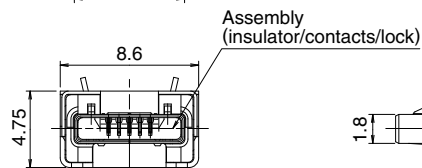
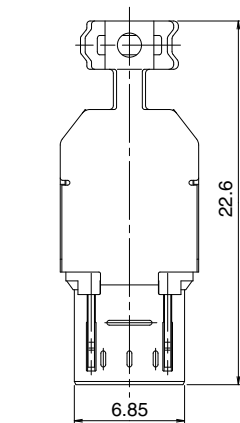

All dimensions : mm

■ Plug-Vertical, cradle mount, Shell through hole

● Micro B, with lock

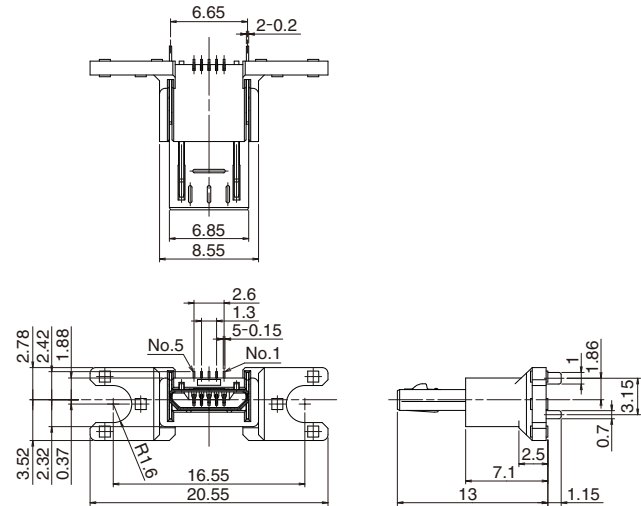
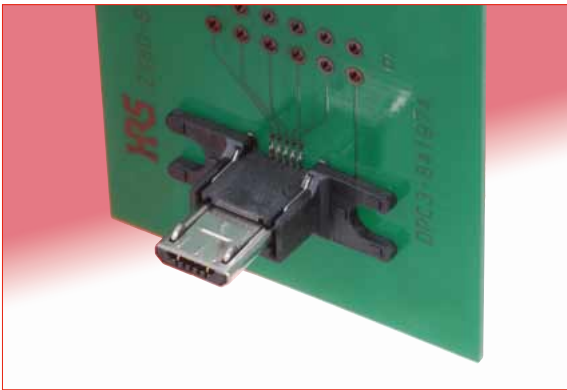

Part No.	HRS No.	Packaging
ZX80-B-5S(30)	242-0017-1 30	100pcs/pks

All dimensions : mm

● Micro B, without lock

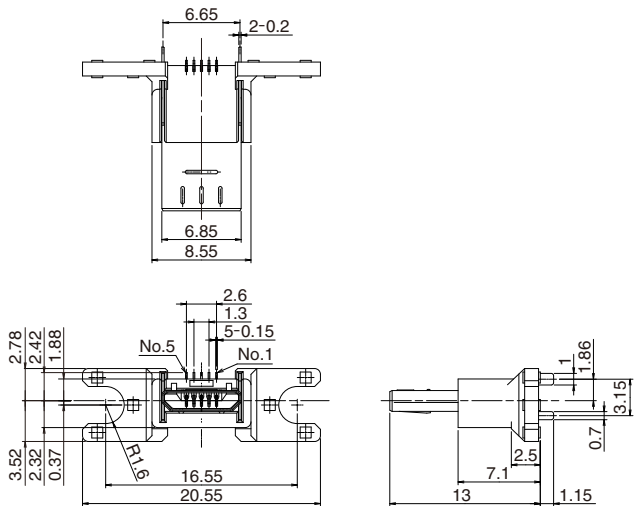
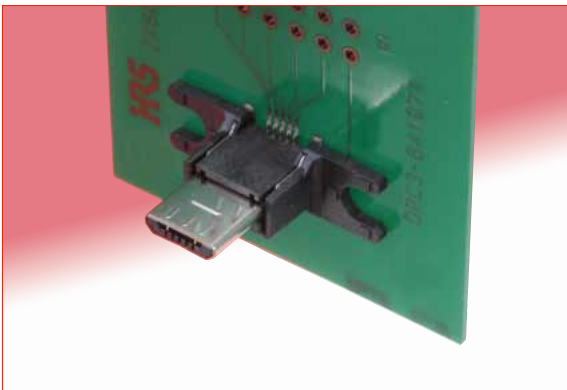

Part No.	HRS No.	Packaging
ZX80-B-5SA(30)	242-0019-7 30	100pcs/pks

◆ PCB mounting pattern

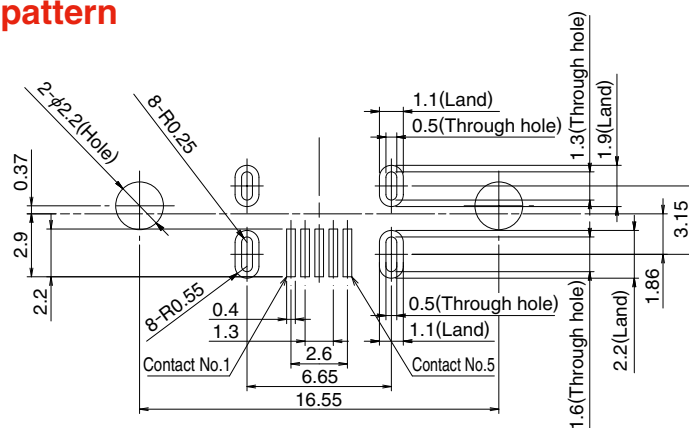

All dimensions : mm

◆ Packaging Specifications

● Embossed carrier tape dimensions

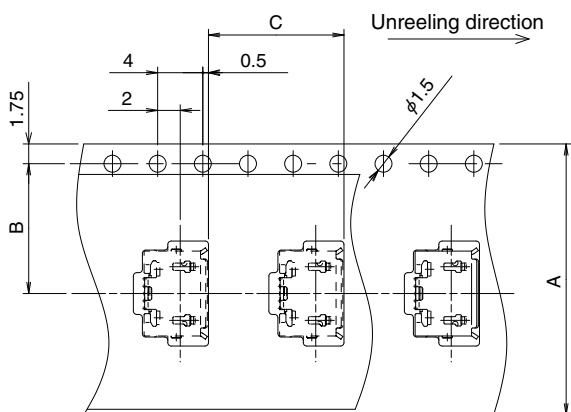

Part No.	A dimension	B dimension
ZX62-B-5PA(33)	24	11.5
ZX62-AB-5PA(31)	24	11.5
ZX62M-B-5P(30)	24	11.5
Other	16	7.5

● Reel Dimensions

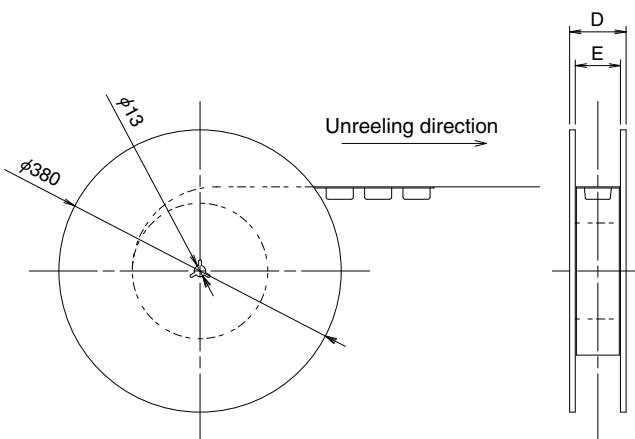

Part No.	D dimension	E dimension
ZX62-B-5PA(33)	30.4	24.4
ZX62-AB-5PA(31)	30.4	24.4
ZX62M-B-5P(30)	30.4	24.4
Other	22.4	16.4

◆ Recommended Temperature Profile - Receptacles

● Using lead-free solder paste

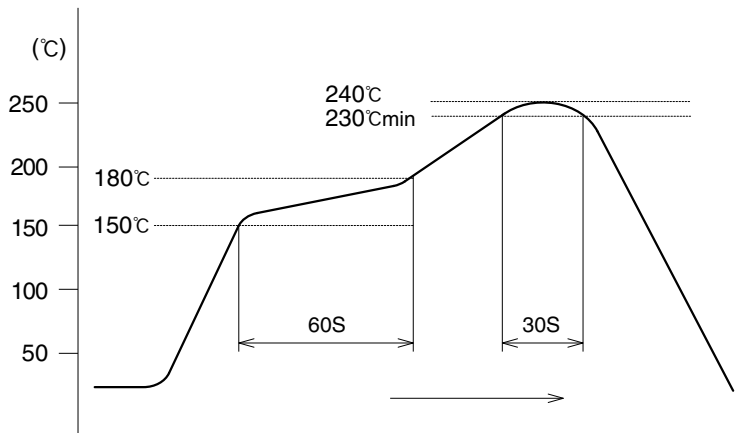

The temperature profile is based on the left conditions.

In individual applications the actual temperature may vary, depending on solder paste type, volume/thickness and board size/thickness. Contact your solder paste and equipment manufacturer for specific recommendations.

Note 1 : Up to 2 cycles of Reflow soldering are possible under the same conditions, provided that there is a return to normal temperature between the first and second cycle.

Note 2 : The temperature profile indicates the board surface temperature at the point of contacts with the connector terminals.

◆ Precautions

1. Exercise care when handling the connectors. Do not subject them to excessive external forces when mating/un-mating.
2. Mate and un-mate as intended, holding by the overmolded body, in the correct direction. Do not un-mate by pulling on the cable.
3. Some tooling marks may be visible on the surfaces of receptacle (shell/cover). No form/fit or function is affected.
4. Appearance of the surface finishes on the receptacles may vary between production runs. No affect on form, fit or function.

USA:

HIROSE ELECTRIC (U.S.A.), INC. HEADQUARTERS CHICAGO OFFICE
2300 Warrenville Road, Suite 150,
Downers Grove, IL 60515
Phone : +1-630-282-6700
<http://www.hirose.com/us/>

USA:

HIROSE ELECTRIC (U.S.A.), INC. SAN JOSE OFFICE
2841 Junction Ave, Suite 200
San Jose, CA. 95134
Phone : +1-408-253-9640
Fax : +1-408-253-9641
<http://www.hirose.com/us/>

USA:

HIROSE ELECTRIC (U.S.A.), INC. DETROIT OFFICE (AUTOMOTIVE)
17197 N. Laurel Park Drive, Suite 253,
Livonia, MI 48152
Phone : +1-734-542-9963
Fax : +1-734-542-9964
<http://www.hirose.com/us/>

USA:

HIROSE ELECTRIC (U.S.A.), INC. BOSTON OFFICE
300 Brickstone Square Suite 201,
Andover, MA 01810
Phone : +1-978-662-5255

THE NETHERLANDS:

HIROSE ELECTRIC EUROPE B.V.
Hogehillweg #8 1101 CC Amsterdam Z-0
Phone : +31-20-6557460
Fax : +31-20-6557469
<http://www.hirose.com/eu/>

GERMANY:

HIROSE ELECTRIC EUROPE B.V. GERMAN BRANCH
Schoenbergstr. 20, 73760 ostfildern
Phone : +49-711-456002-1
Fax : +49-711-456002-299
<http://www.hirose.com/eu/>

GERMANY:

HIROSE ELECTRIC EUROPE B.V. NUREMBERG OFFICE
Neumeyerstrasse 22-26, 90411 Nurnberg
Phone : +49-911 32 68 89 63
Fax : +49-911 32 68 89 69
<http://www.hirose.com/eu/>

GERMANY:

HIROSE ELECTRIC EUROPE B.V. HANOVER OFFICE
Bayernstr. 3, Haus C 30855 Langenhagen, Germany
Phone : +49-511 97 82 61 30
Fax : +49-511 97 82 61 35
<http://www.hirose.com/eu/>

FRANCE:

HIROSE ELECTRIC EUROPE B.V. PARIS OFFICE
130 Avenue Joseph Kessel, Bat E, 78960
Voisins le Bretonneux, France
Phone : +33-1-85764886
Fax : +33-1-85764823
<http://www.hirose.com/eu/>

UNITED KINGDOM:

HIROSE ELECTRIC EUROPE BV (UK BRANCH)
4 Newton Court, Kelvin Drive, Knowlhill,
Milton Keynes, MK5 8NH
Phone : +44-1908 202050
Fax : +44-1908 202058
<http://www.hirose.com/eu/>

CHINA:

HIROSE ELECTRIC (SHANGHAI) CO., LTD.
18, Enterprise Center Tower 2, 209# Gong He
Road, Jing'an District, Shanghai, CHINA 200070
Phone : +86-21-6391-3355
Fax : +86-21-6391-3335
<http://www.hirose.com/cn/>

CHINA:

HIROSE ELECTRIC (SHANGHAI) CO.,LTD. BEIJING BRANCH
A1001, Ocean International Center, Building 56# East 4th
Ring Middle Road, ChaoYang District, Beijing, 100025
Phone : +86-10-5165-9332
Fax : +86-10-5908-1381
<http://www.hirose.com/cn/>

CHINA:

HIROSE ELECTRIC TECHNOLOGIES (SHENZHEN) CO., LTD.
Room 09-13, 19/F, Office Tower Shun Hing Square, Di Wang Commercial Centre,
5002 Shen Nan Dong Road, Shenzhen City, Guangdong Province, 518008
Phone : +86-755-8207-0851
Fax : +86-755-8207-0873
<http://www.hirose.com/cn/>

HONG KONG:

HIROSE ELECTRIC HONGKONG TRADING CO., LTD.
Room 1001, West Wing, Tsim Sha Tsui Centre, 66
Mody Road, Tsim Sha Tsui East, Kowloon, Hong Kong
Phone : +852-2803-5338
Fax : +852-2591-6560
<http://www.hirose.com/hk/>

TAIWAN:

HIROSE ELECTRIC TAIWAN CO., LTD.
103 8F, No.87, Zhengzhou Rd., Taipei
Phone : +886-2-2555-7377
Fax : +886-2-2555-7355
<http://www.hirose.com/tw/>

KOREA:

HIROSE KOREA CO.,LTD.
143, Gongdan 1-daero, Siheung-si,
Gyeonggi-do, 15084, Korea
Phone : +82-31-496-7000
Fax : +82-31-496-7100
<http://www.hirose.co.kr/>

SINGAPORE:

HIROSE ELECTRIC SINGAPORE PTE. LTD.
03, Anson Road, #20-01, Springleaf Tower,
Singapore 079909
Phone : +65-6324-6113
Fax : +65-6324-6123
<http://www.hirose.com/sg/>

INDIA:

HIROSE ELECTRIC SINGAPORE PTE. LTD. DELHI LIAISON OFFICE
Office NO.552, Regus-Green Boulevard, Level5, Tower C,
Sec62, Plot B-9A, Block B, Noida, 201301, Uttar Pradesh, India
Phone : +91-12-660-8018
Fax : +91-120-4804949
<http://www.hirose.com/sg/>

INDIA:

HIROSE ELECTRIC SINGAPORE PTE. LTD. BANGALORE LIAISON OFFICE
Unit No-403, 4th Floor, No-84, Barton Centre, Mahatma
Gandhi (MG) Road, Bangalore 560 001, Karnataka, India
Phone : +91-80-4120 1907
Fax : +91-80-4120 9908
<http://www.hirose.com/sg/>

MALAYSIA:

PENANG REPRESENTATIVE OFFICE
73-3-1, Ideal@The One, Jalan Mahsuri, Bayan
Lepas Penang, 11950, Malaysia
Phone : +604-648-5536
<http://www.hirose.com/sg/>

THAILAND:

BANGKOK OFFICE (REPRESENTATIVE OFFICE)
Unit 4703, 47th FL., 1 Empire Tower, South Sathorn
Road, Yannawa, Sathorn, Bangkok 10120 Thailand
Phone : +66-2-686-1255
Fax : +66-2-686-3433
<http://www.hirose.com/sg/>



HIROSE ELECTRIC CO.,LTD.

2-6-3,Nakagawa Chuoh,Tsuzuki-Ku,Yokohama-Shi 224-8540,JAPAN
TEL: +81-45-620-3526 Fax: +81-45-591-3726
<http://www.hirose.com>
<http://www.hirose-connectors.com>