

# Lightweight SMT Miniature Coaxial Connectors – 1.4 mm Mated Height

## N.FL Series

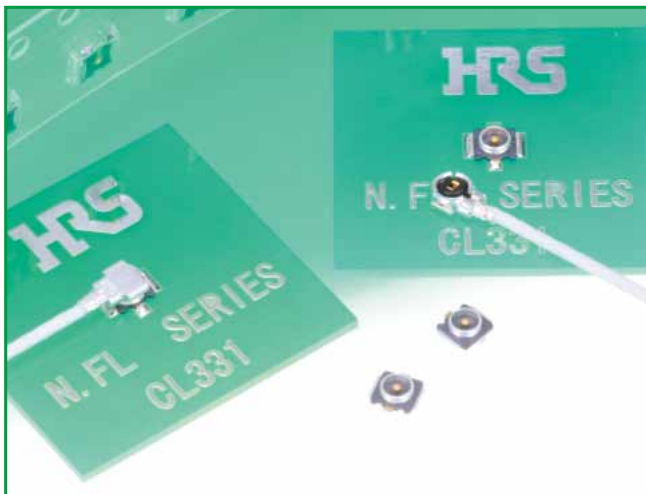

### ● Mated height comparison (With U.FL-LP(V) )

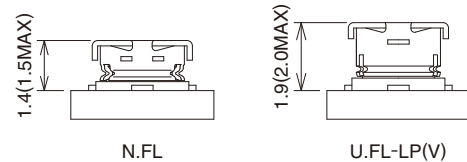

Fig.1

### ■ Features

#### 1. Low profile

Nominal mated height is 1.4 mm (Max. 1.5 mm)

#### 2. Small size: 7.7 mm<sup>2</sup>

#### 3. Light weight

Receptacle : 14 mg  
Plug : 28 mg

#### 4. Accepts high frequency transmission of DC to 6 GHz.

V.S.W.R. = 1.3 max. (DC to 6 GHz)

#### 5. Board placement with automatic equipment

Receptacles are packaged in embossed carrier tape and reel for automatic mounting.

#### 6. Plugs are terminated with ultra-fine coaxial (fluorinated resin insulated) cable.

#### 7. Special tool for an extraction

#### 8. Verification of the fully mated condition

Tactile click sensation confirms fully mated condition, assuring complete electrical and mechanical connection.

#### 9. Halogen-free\*(Receptacle, plug(HF type))

\*As defined by IEC61249-2-21

Br-900 ppm maximum, Cl-900 ppm maximum,  
Cl+Br combined - 1,500 ppm maximum

### ■ Applications

Mobile phones, wireless communication devices, electronic measuring instruments, GPS, wireless LAN, Bluetooth and any application requiring high frequency transmission using small coaxial connectors.

### ● N.FL Plug and Receptacle

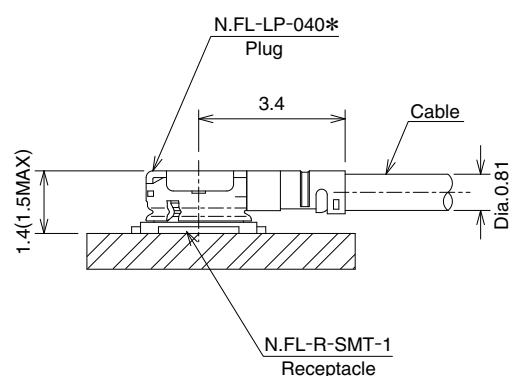

Fig.2

## ■ Specifications

|         |                                  |             |                             |                                 |
|---------|----------------------------------|-------------|-----------------------------|---------------------------------|
| Ratings | Nominal characteristic impedance | 50 ohms     | Operating temperature range | -40°C to +90°C<br>(90% RH max.) |
|         | Frequency range                  | DC to 6 GHz | Storage temperature range   | -30°C to +70°C<br>(90% RH max.) |

| Item                     | Specification   | Conditions   |
|--------------------------|---|--|
| 1. Contact resistance    | Center contact: 25 m ohms max.<br>Outer contact: 25 m ohms max.   | 10 mA max.   |
| 2. Insulation resistance | 500 M ohms min.   | 100V DC  |
| 3. Withstanding voltage  | No flashover or insulation breakdown  | 200V AC / 1 minute   |
| 4. V.S.W.R.(Note)        | 1.3max.   | DC to 6GHz   |
| 5. Durability            | Contact resistance Center contact: 30 m ohms max.<br>Outer contact: 30 m ohms max.<br>No damage, cracks, or parts dislocation                     | 20 cycles  |
| 6. Vibration             | No electrical discontinuity of 1 μs or longer<br>No damage, cracks, or parts dislocation  | Frequency: 10 to 100 Hz, single amplitude of 1.5 mm<br>Acceleration: 59 m/s <sup>2</sup> , in each of 3 axis<br>5 cycles |
| 7. Shock                 | No electrical discontinuity of 1 μs or longer<br>No damage, cracks, or parts dislocation  | Acceleration of 735 m/s <sup>2</sup> , 11 ms continuous time<br>Waveform: sine half-wave, 3 cycles in each of the 3 axis |
| 8. Humidity              | Insulation resistance: 100 M ohms min. (high humidity)<br>Insulation resistance: 500 M ohms min. (dry)<br>No damage, cracks, or parts dislocation | 96 hours at +40°C, and humidity of 95%   |
| 9. Temperature cycle     | No damage, cracks, or parts dislocation   | Temperature:-40°C→+5°C to +35°C→+90°C→+5°C to +35°C<br>Time: 30 min.→ 5 min. max. → 30 min. → 5 min. max.<br>5 cycles    |
| 10. Salt spray test      | No excessive corrosion  | 5% salt water solution, 48 hours   |

Note: Information contained in this catalog represents general requirements for this Series. Contact us for the drawings and specifications for a specific part number shown.

\* V.S.W.R. Measurement System  
Measured as shown on the block diagram below.

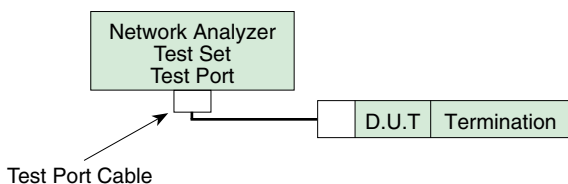

Note1: N.FL Cable assembly (plug) is measured with SMA conversion adapters mated with N.FL plugs at both ends of a 100cm coaxial cable harness

Note2: N.FL receptacle, which is mounted on a 50 ohms glass epoxy board, is measured with a SMA conversion adapter.

## ■ Materials / Finishes

### ●Plugs-Right Angle

| Part                  | Material        | Finish                       |
|-----------------------|-----------------|------------------------------|
| Shell                 | Phosphor bronze | Silver plated                |
| Female center contact | Phosphor bronze | Gold plated                  |
| Insulator             | PBT             | Color: Black, UL94V-0        |
|                       |                 | Color: Gray, UL94HB(HF type) |

### ●Receptacle

| Part                | Material        | Finish                |
|---------------------|-----------------|-----------------------|
| Shell               | Phosphor bronze | Silver plated         |
| Male center contact | Brass           | Gold plated           |
| Insulator           | LCP             | Color: Black, UL94V-0 |

## ■ Cable Assembly(Plug)

N.FL-LP-040(06), N.FL-LP-040HF(06)(Applicable cable: outer diameter 0.81)

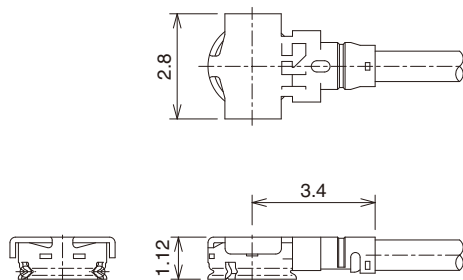

Ordering Information

[Plugs can be ordered only as terminated cable assemblies]

## ◆ How To Specify Cable Assembly

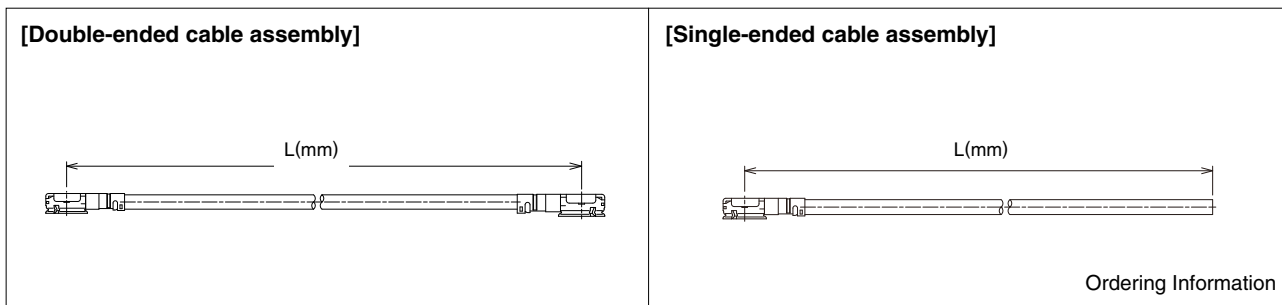

### ● Ordering Information

Used Plug: N.FL-LP-040(06), N.FL-LP-040HF(06)

Double-Ended **N.FL - 2LP HF6 - 04N [ ] TV-A - L**  
 ① ② ③ ④ ⑤ ⑥ ⑦

Single-Ended **N.FL - LP HF6 - 04N [ ] TV-A - L**  
 ① ② ③ ④ ⑤ ⑥ ⑦

|                           |  |
|---------------------------|--|
| ① Series name             | N.FL   |
| ② Assembly type           | LP : Single ended<br>2LP : Double ended      |
| ③ Environmental compliant | HF6 : Halogen-free plug<br>6 : Standard Plug |
| ④ Cable type              | 04N : 0.81mm dia. ultra-time coaxial cable   |
| ⑤ Cable color             | 1:White 2:Black                              |
| ⑥ Cable outer conductor   | TV: Tin plated braided wire                  |
| ⑦ Total length (mm)       | Length(L)                                    |

### ● Standard tolerances for (L)

| (L)mm              | Standard Tolerance(mm) |
|--------------------|------------------------|
| *L=35 to 200       | ±4                     |
| *L=200 to 500      | ±8                     |
| *L=500 to 1000     | ±12                    |
| L=Longer than 1000 | ±1.5% of (L)           |

Note: Minimum available length(L) is 35mm.

## ■ Receptacle

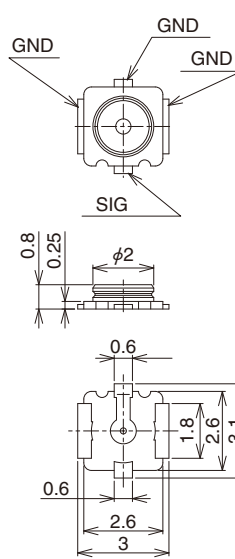
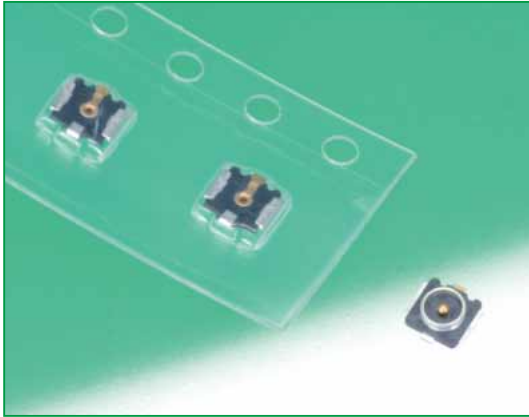

## ◆ Recommended PCB mounting pattern

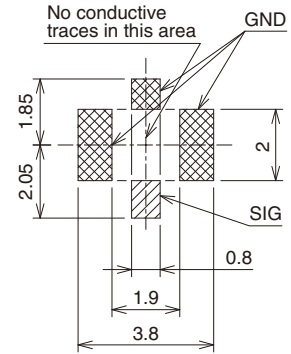

All dimensions: mm

| Part No.         | HRS No.       | Packaging              | RoHS |
|------------------|---------------|------------------------|------|
| N.FL-R-SMT-1(60) | 331-0332-3 60 | Reel (5,000 pcs/reel)  | ○    |
| N.FL-R-SMT-1(80) | 331-0332-3 80 | Reel (10,000 pcs/reel) |      |

## ● Embossed Carrier Tape Dimensions (IEC 60286-3 compliant)

### Embossed Carrier tape Dimensions

(N.FL-R-SMT-1(60) 8mm pitch)

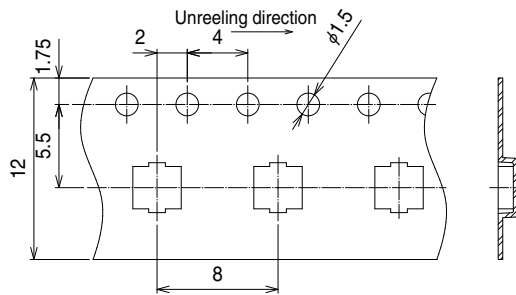

(N.FL-R-SMT-1(80) 4mm pitch)

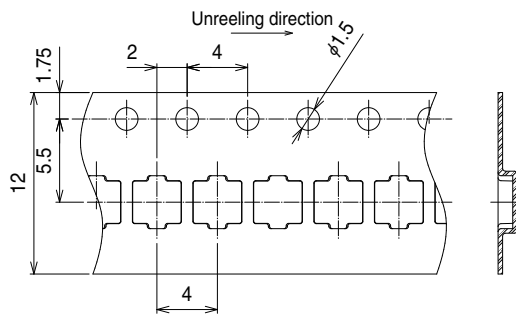

### Reel Dimensions

Material : PS(Black)

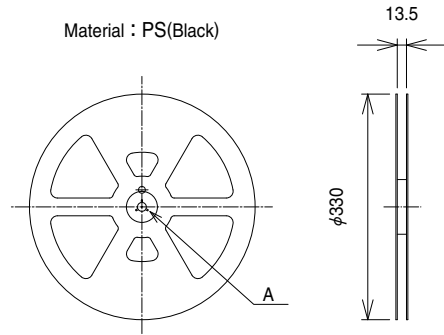

A (SCALE FREE)

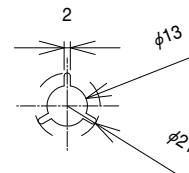

All dimensions: mm

## ■ Conversion Adapters

### ● SMA Conversion Adapter (N.FL / U.FL side jack - SMA side plug)



Note: The FL side mating portions has a lower lock retention force than the regular product, therefore, cannot be used for purposes other than performance measurements.

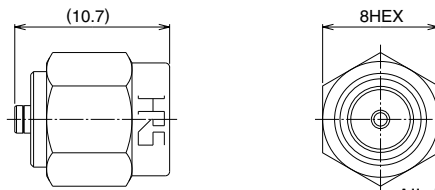

All dimensions: mm

| Part No.       | HRS No.       | RoHS |
|----------------|---------------|------|
| HRMP-U.FLJ(40) | 311-0300-2 40 | ○    |

Note: Applicable to both N.FL and U.FL.

### ● SMA Conversion Adapter (N.FL / U.FL side plug - SMA side jack)



Note: The FL side mating portions has a lower lock retention force than the regular product, therefore, cannot be used for purposes other than performance measurements.

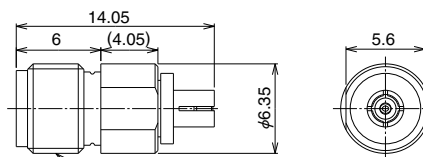

All dimensions: mm

| Part No.       | HRS No.       | RoHS |
|----------------|---------------|------|
| HRMJ-U.FLP(40) | 311-0301-5 40 | ○    |

Note: Applicable to both N.FL and U.FL.

### ● SMA Conversion Adapter



Note: When mating with corresponding part (N.FL-R-SMT-1) must be pressed down and held to make complete connection.

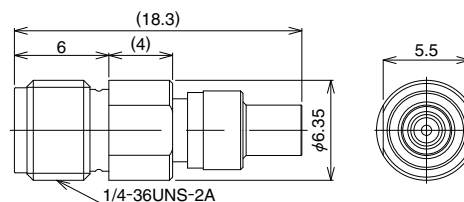

All dimensions: mm

| Part No.       | HRS No.    | RoHS |
|----------------|------------|------|
| HRMJ-N.FLP-ST5 | 311-0423-2 | ○    |

## ■ Receptacle Inspection Adapter

Used for inspecting the performance parameters of the cable assembly.

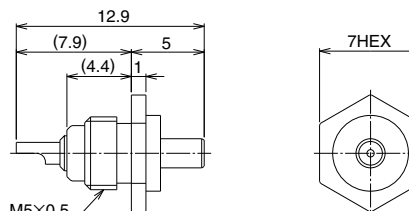
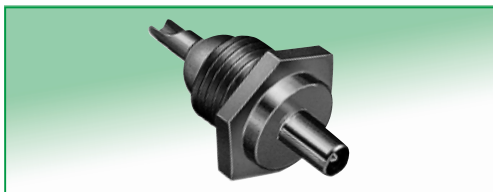

All dimensions: mm

| Part No. | HRS No.    | RoHS |
|----------|------------|------|
| U.FL-R-1 | 331-0466-0 | ○    |

Note: Applicable to both N.FL and U.FL.

## ◆ Plug mating tool

This tool is used for mating a plug.

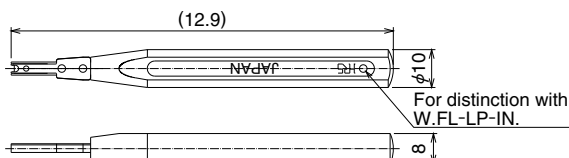

All dimensions: mm

| Part No.   | HRS No.    | RoHS |
|------------|------------|------|
| U.FL-LP-IN | 331-0334-9 | ○    |

## ◆ Plug extraction tool

This jig is used for extraction from a mating condition.

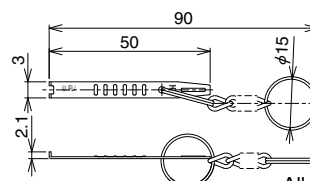

All dimensions: mm

| Part No.       | HRS No.    | RoHS |
|----------------|------------|------|
| U.FL-LP(V)-N-2 | 331-0493-2 | ○    |

Note: Applicable to all the U.FL-LP(V)-040, U.FL-LP-062 and N.FL.

## Usage Precautions

### 1. Plug

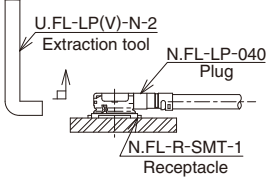
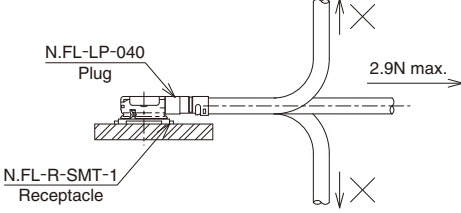
|   |   |
|---|---|
| (1) Mating / unmating                                   | <ul style="list-style-type: none"> <li>• <b>Unmating</b> Insert the end of an extraction tool into a space between a plug and receptacle, and pull up the tool in the perpendicular to a mounting surface of a receptacle, as shown in the figure.                     <ul style="list-style-type: none"> <li>● Recommended the use of the extraction tool for unmating. Any attempt of unmating by pulling on the cable may result in damage to the mechanical / electrical performance.</li> </ul> </li> <li>• <b>Mating</b> Do not attempt to insert on an extreme angle.</li> </ul>  |
| (2) Pull forces on the cable after connectors are mated | <p>Do not apply any pull forces after the bending of the cable.</p>   |
| (3) Precautions   | Do not twist connectors excessively during mating / unmating.   |

### 2. Receptacle

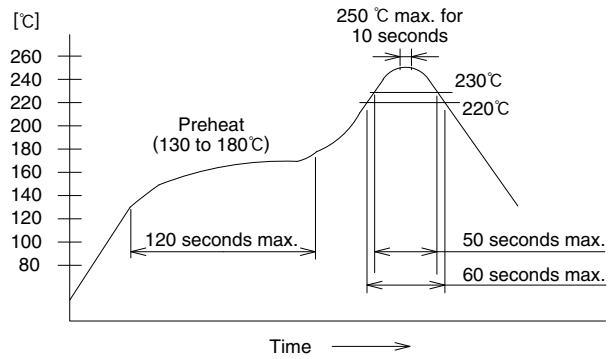
|  |  |
|--|--|
| (1) Recommended reflow temperature profile |  <p>① The temperature profile indicates the board surface temperature at the point of contacts with the connector leads.</p> <p>② In individual applications the actual temperature may vary, depending on the solder paste type, volume / thickness and board size / thickness. Consult your solder paste and equipment manufacturer for the detailed recommendations.</p> |
| (2) Manual soldering                       | Soldering iron temperature: 350°C, Soldering time: for 5 seconds max.  |
| (3) Recommended metal mask thickness       | 0.1 mm to 0.12 mm  |
| (4) Reflow cycles                          | 2 times  |

### 3. Operating environment and storage conditions

|                                     |   |
|-------------------------------------|---|
| (1) Operating environment           | <p>The connectors are not designed to operate in the following environments:</p> <ul style="list-style-type: none"> <li>• Exposed to a excessive amounts of fine particles and dust</li> <li>• Regions and places having a high density of sulfur dioxide, hydrogen sulfide, nitrogen dioxide or other corrosive gasses.</li> <li>• Environments having large rapid variations in temperature.</li> </ul> |
| (2) Storage conditions - Receptacle | <p>Store in the Hirose Electric packaging.<br/>         Temperature: -10 to +40°C, Humidity: 85% max.<br/>         Use within 6 months of delivery.<br/>         Receptacles for which the storage period has elapsed must be tested for solderability to the PC board mounting surface.</p>  |



**HIROSE ELECTRIC CO.,LTD.**

2-6-3,Nakagawa Chuoh,Tsuzuki-Ku,Yokohama-Shi 224-8540,JAPAN

TEL: +81-45-620-3526 Fax: +81-45-591-3726

<http://www.hirose.com>

<http://www.hirose-connectors.com>