

Dec.1.2019 Copyright 2019 HIROSE ELECTRIC CO., LTD. All Rights Reserved.  
In case of consideration for using Automotive equipment / device which demand high reliability, kindly contact our sales window correspondents.

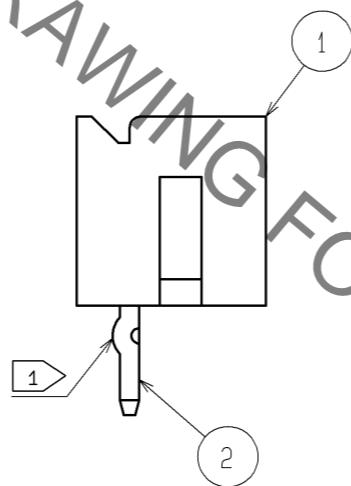

CODE No.	PART No.	CONTACT	A	B	C
CL543-0165-0	DF3A- 2P-2DSA	2	6.0	4.6	2.0
CL543-0166-2	DF3A- 3P-2DSA	3	8.0	6.6	4.0
CL543-0167-5	DF3A- 4P-2DSA	4	10.0	8.6	6.0
CL543-0168-8	DF3A- 5P-2DSA	5	12.0	10.6	8.0
CL543-0169-0	DF3A- 6P-2DSA	6	14.0	12.6	10.0
CL543-0170-0	DF3A- 7P-2DSA	7	16.0	14.6	12.0
CL543-0171-2	DF3A- 8P-2DSA	8	18.0	16.6	14.0
CL543-0172-5	DF3A- 9P-2DSA	9	20.0	18.6	16.0
CL543-0173-8	DF3A-10P-2DSA	10	22.0	20.6	18.0
CL543-0174-0	DF3A-11P-2DSA	11	24.0	22.6	20.0
CL543-0175-3	DF3A-12P-2DSA	12	26.0	24.6	22.0
CL543-0176-6	DF3A-13P-2DSA	13	28.0	26.6	24.0
CL543-0177-9	DF3A-14P-2DSA	14	30.0	28.6	26.0
CL543-0178-1	DF3A-15P-2DSA	15	32.0	30.6	28.0

A-A

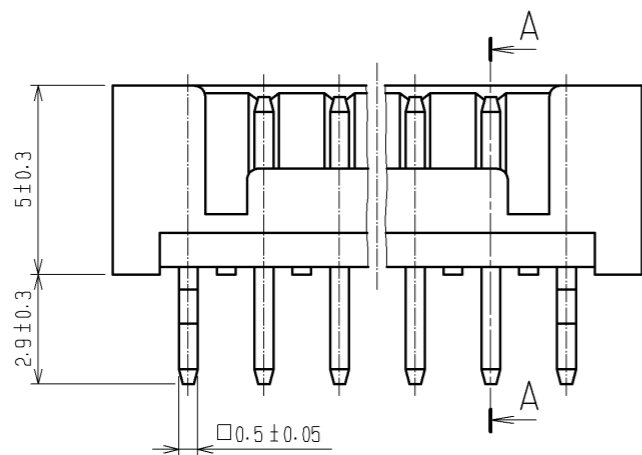
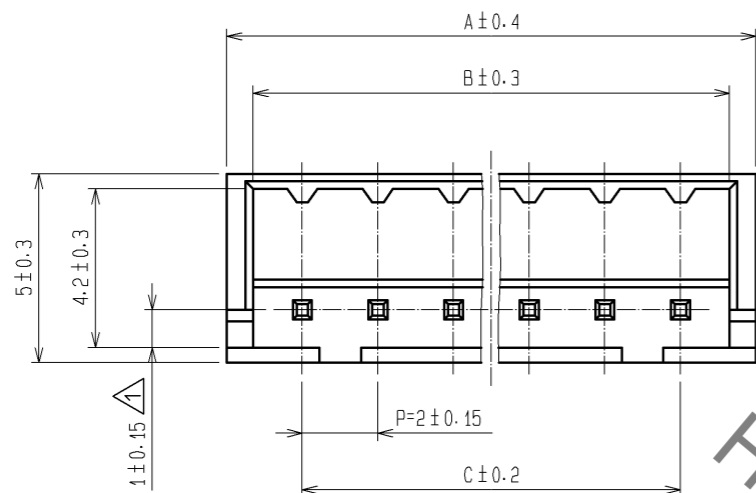
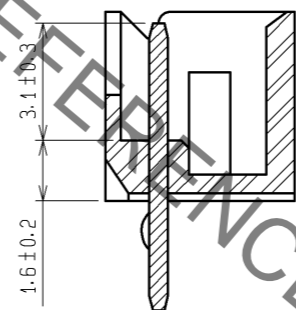

RECOMMENDED PATTERN

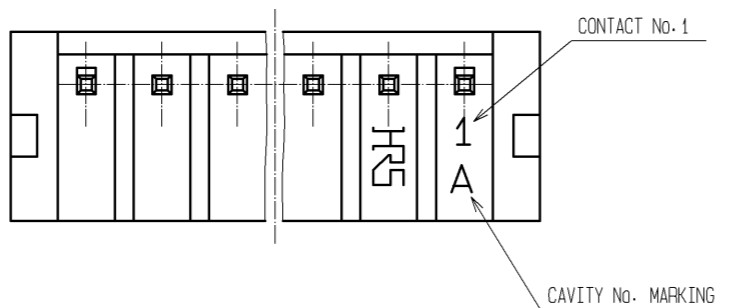
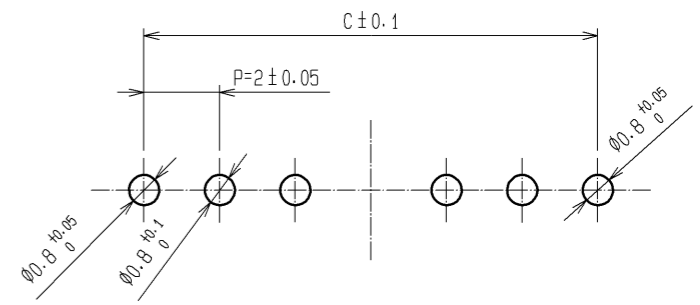

NOTES 1: KINK PROCESSING IS CARRIED OUT TO THE TERMINAL OF BOTH SIDES. (CONTACT No. 1, No. \*)

NO.	MATERIAL	FINISH . REMARKS	NO.	MATERIAL	FINISH . REMARKS
1	POLYAMIDE	BLACK. UL94V-0	2	BRASS	SURFACE:TIN PLATED 1μ min UNDER PLATING:NICKEL PLATED 0.5μ min

UNITS	SCALE	COUNT	DESCRIPTION OF REVISIONS	DESIGNED	CHECKED	DATE
mm	5 : 1	1	DIS-H-004732	MI. SAKIMURA	TS. FUKUSHIMA	10. 04. 09

APPROVED	DATE	DRAWING NO.
TY. OMA	06. 08. 31	EDC3-162184-03
CHECKED	DATE	PART NO.
HK. UMEHARA	06. 08. 31	DF3A- * P-2DSA
DESIGNED	DATE	CODE NO.
TS. KUMAZAWA	06. 08. 30	CL543
DRAWN	DATE	
AK. MIURA	06. 08. 29	