

COUNT	DESCRIPTION OF REVISIONS	BY	CHKD	DATE	COUNT	DESCRIPTION OF REVISIONS	BY	CHKD	DATE
5	RE-H-05647	A.H.K.A	T.O.S	6.30					
1	RE-H-05903	T.Y.T.S	T.O.S	3.11.13					

Fig.1 : A-A(10:1)

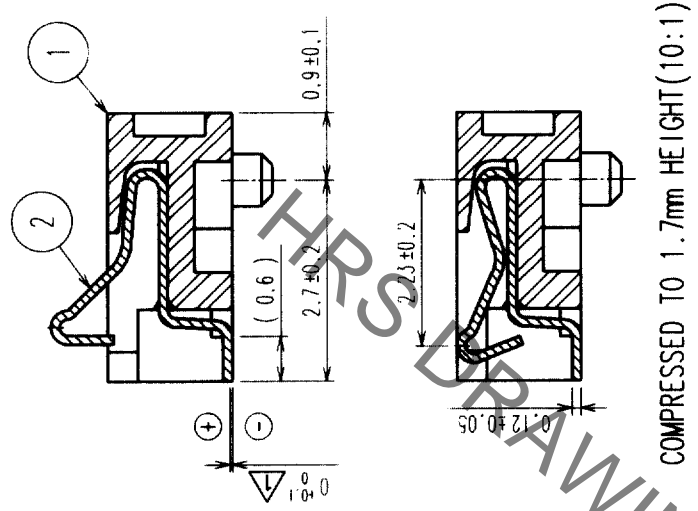
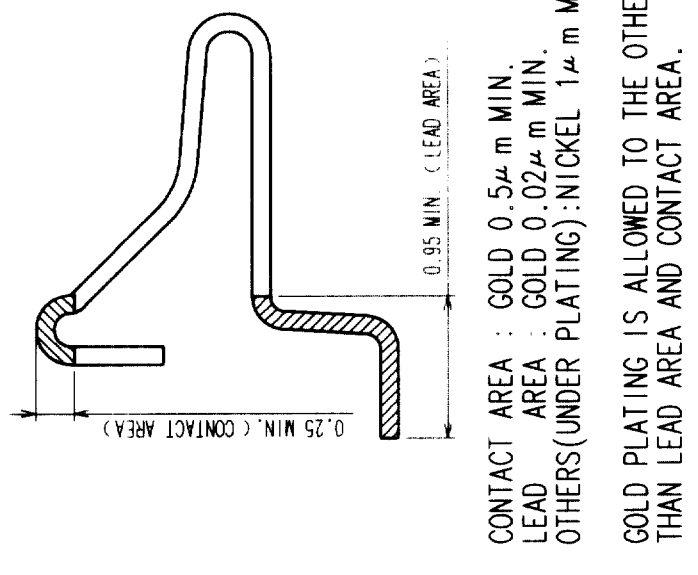

Fig.2 : PLATING SPECIFICATION (20:1)



CONTACT AREA : GOLD 0.5 μ m MIN.
 LEAD AREA : GOLD 0.02 μ m MIN.
 OTHERS(UNDER PLATING) : NICKEL 1 μ m MIN.
 GOLD PLATING IS ALLOWED TO THE OTHER SURFACE THAN LEAD AREA AND CONTACT AREA.

Fig.3 : RECOMMENDED PATTERN FOR MOUNTING (5:1)

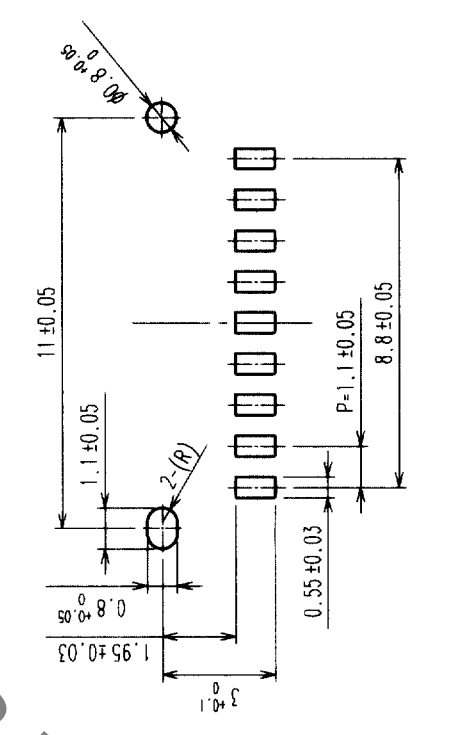
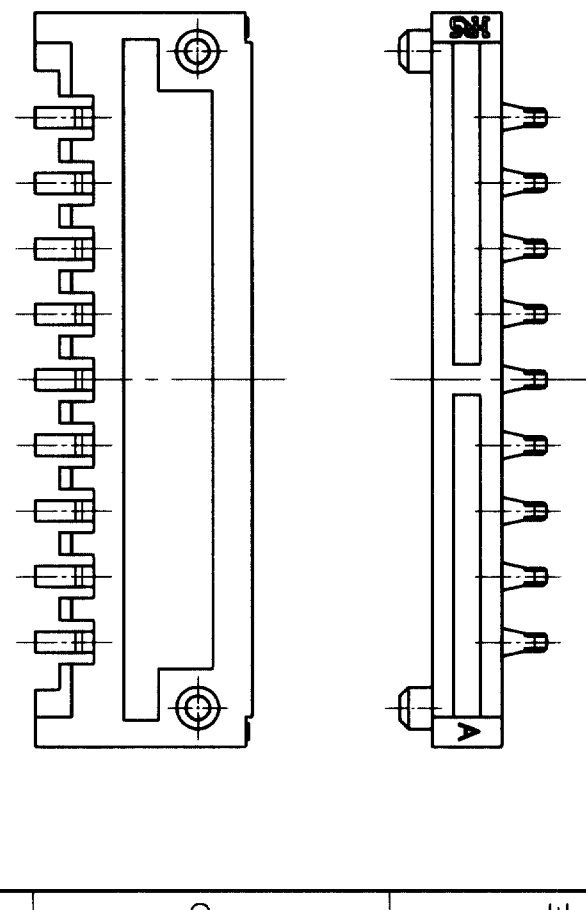
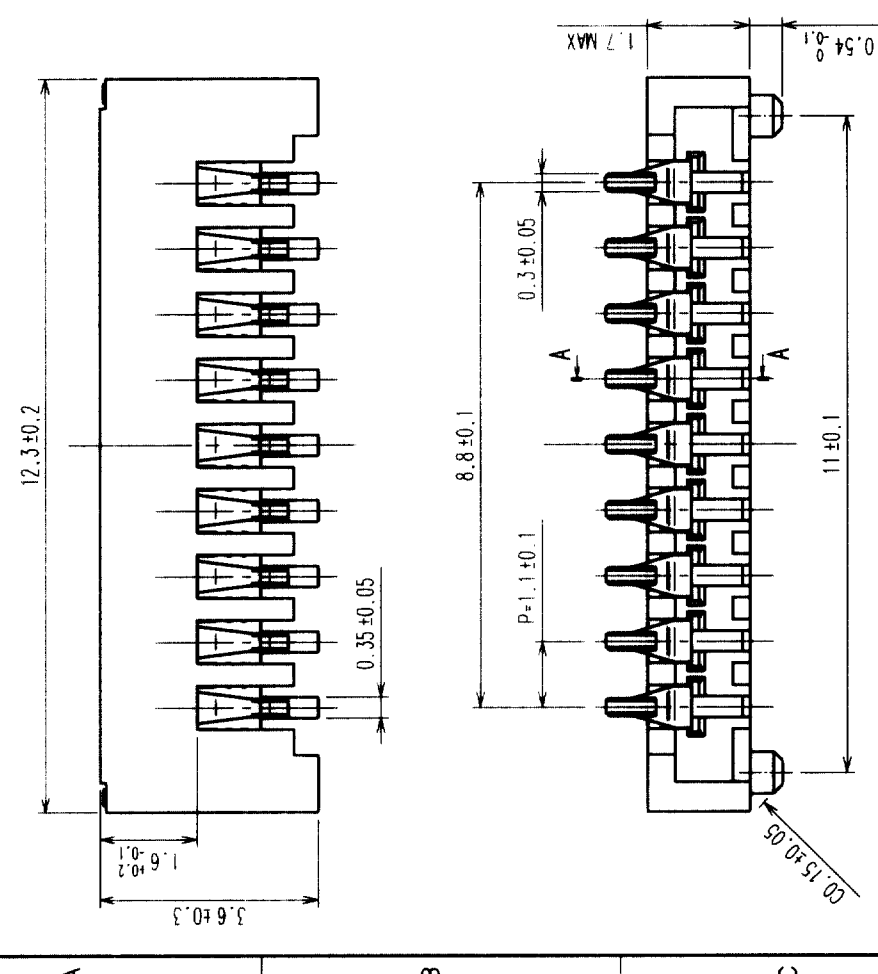
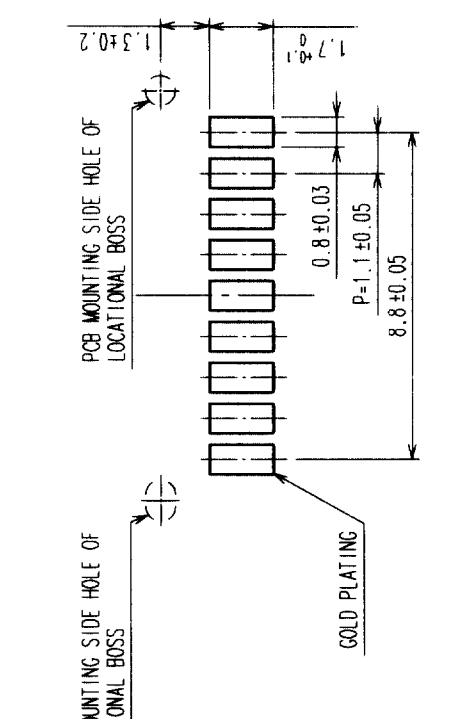

Fig.4 : RECOMMENDED PATTERN FOR MATING (5:1)



NOTES 1. LEAD COPLANARITY SHALL BE WITHIN 0.1mm
 2. THIS PRODUCT TO BE SHIPPED BY TAPE AND REEL PACKAGE.
 REFER TO NEXT SHEET FOR DETAILS OF PACKAGING SPECIFICATIONS.

NO.	PHOSPHOR BRONZE	REFER TO Fig.2	4	POLYESTER	CLEAR(COVER TAPE)
1	LCP	BLACK, UL94V-0	3	PS	CLEAR(EMBOSSED CARRIER TAPE)
NO.	MATERIAL	FINISH, REMARKS	NO.	MATERIAL	FINISH, REMARKS
CODE NO. (OLD)					
DRAWN		DESIGNED		CHECKED	
T. Yamamoto		T. Yamamoto		K. Akiyama	
'02.10.3		'02.10.3		'02.10.4	
APPROVED		APPROVED		RELEASED	
K. Katayose		K. Katayose		K. Katayose	
'02.10.4		'02.10.4		'02.10.4	

DRAWING NO.	EDC3-164058-01	PART NO.	DF26A1.7-9CP-1.1V(66)
SCALE	FREE	CODE NO.	CL661-0008-1-66
UNITS	mm		

COUNT		DESCRIPTION OF REVISIONS		BY		CHKD		DATE	

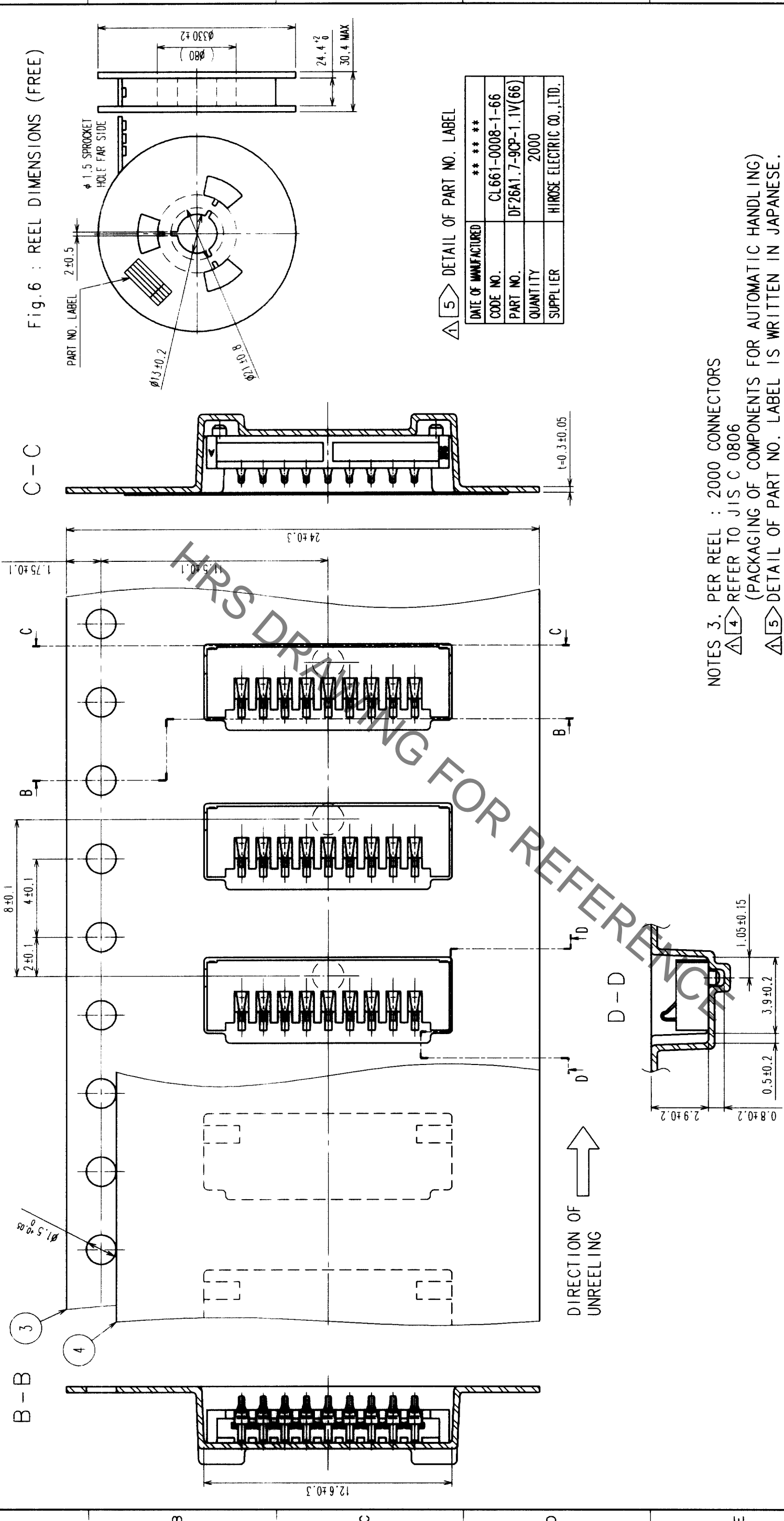
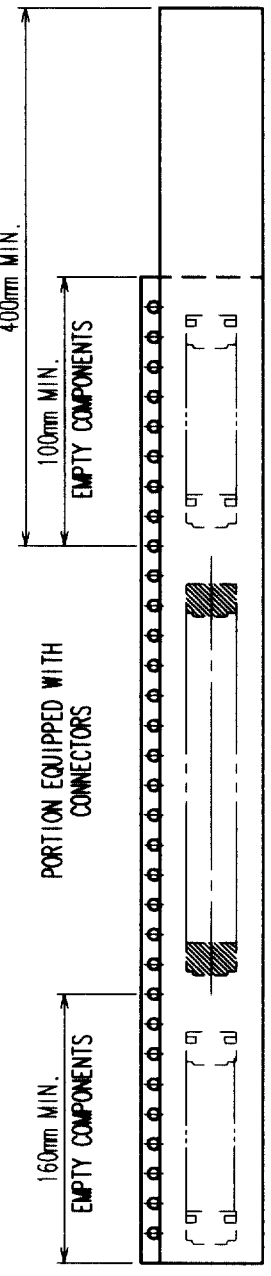

Fig. 5 : TAPING(FREE)



NOTES 3. PER REEL : 2000 CONNECTORS
 4 REFER TO JIS C 0806
 (PACKAGING OF COMPONENTS FOR AUTOMATIC HANDLING)
 5 DETAIL OF PART NO. LABEL IS WRITTEN IN JAPANESE.

Fig. 6 : REEL DIMENSIONS (FREE)

5 DETAIL OF PART NO. LABEL

DATE OF MANUFACTURED	*****
CODE NO.	CL661-0008-1-66
PART NO.	DF26A1.7-9CP-1.1V(66)
QUANTITY	2000
SUPPLIER	HIROSE ELECTRIC CO.,LTD.

CODE NO. (OLD)		DESIGNED	T. Yamamoto	CHECKED	K. Akiyama	APPROVED	K. Katayose	RELEASED	
SCALE	5 : 1	DRAWN	T. Yamamoto	DESIGNED	T. Yamamoto	CHECKED	K. Akiyama	APPROVED	K. Katayose
UNITS	mm	DRAWING NO.	EDC3-164058-01	DESIGNED	T. Yamamoto	CHECKED	K. Akiyama	APPROVED	K. Katayose
		PART NO.	DF26A1.7-9CP-1.1V(66)	DESIGNED	T. Yamamoto	CHECKED	K. Akiyama	APPROVED	K. Katayose
				DESIGNED	T. Yamamoto	CHECKED	K. Akiyama	APPROVED	K. Katayose

TO	