

Dec.1.2019 Copyright 2019 HIROSE ELECTRIC CO., LTD. All Rights Reserved.  
 In case of consideration for using Automotive equipment / device which demand high reliability, kindly contact our sales window correspondents.

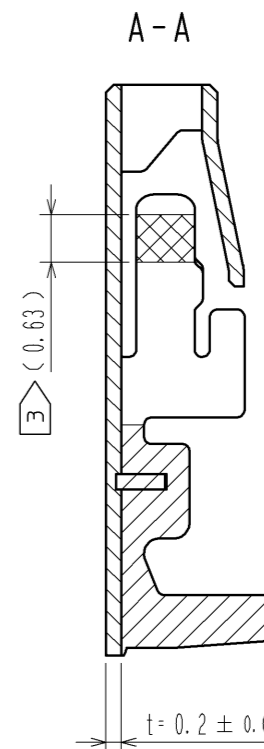
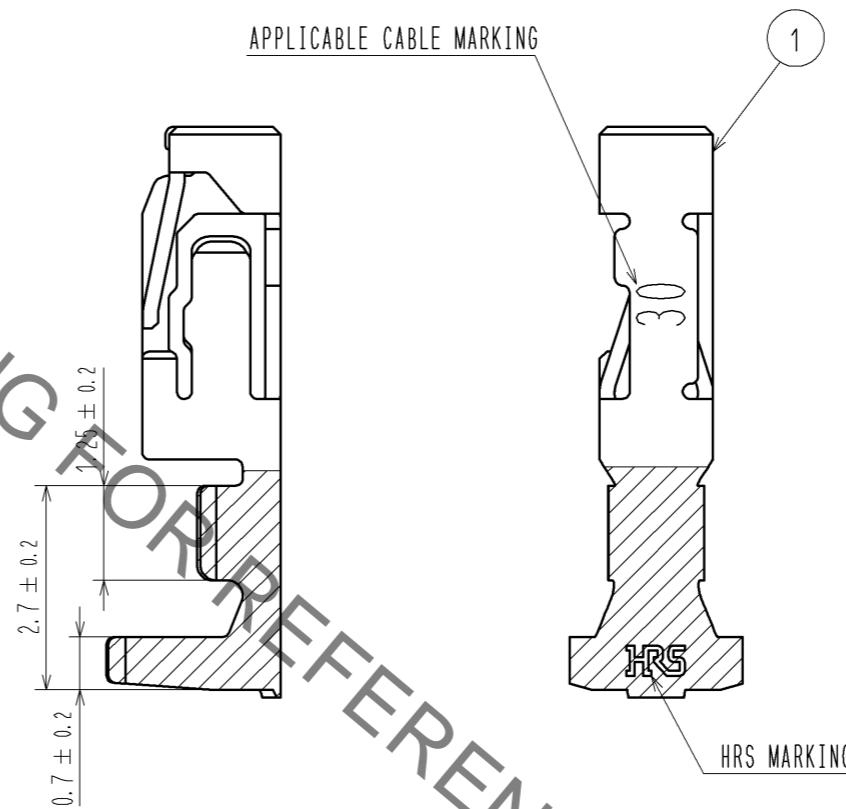
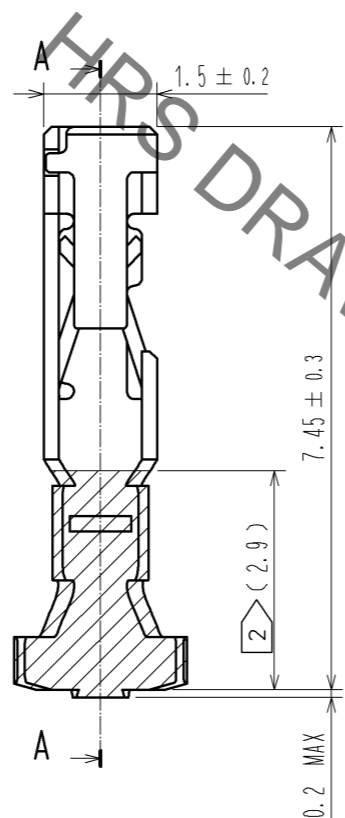
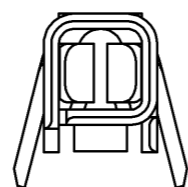
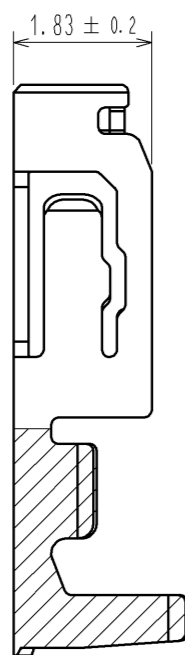

NOTE 1. 1PACK:100 CONTACTS  
 2 TIN PLATING AREA.  
 3 GOLD PLATING AREA.  
 4. THE DIMENSIONS IN PARENTHESIS ARE FOR REFERENCE.

NO.	MATERIAL	FINISH . REMARKS	NO.	MATERIAL	FINISH . REMARKS
1	PHOSPHOR BRONZE				CONTACT AREA : GOLD PLATING 0.2μm MIN BARREL AREA : TIN PLATING 1μm MIN OTHERS : NICKEL PLATING 0.5μm MIN

UNITS	SCALE	COUNT	DESCRIPTION OF REVISIONS	DESIGNED	CHECKED	DATE
mm	10:1	△				
HIROSE ELECTRIC CO., LTD.			APPROVED : KI. AKIYAMA	12.07.21	DRAWING NO. EDC3-345108-00	
			CHECED : MN. KENJO	12.07.21	PART NO. DF62-30SCA	
			DESIGNED : TO. HORII	12.07.20	CODE NO. CL544-0528-8-00	
			DRAWN : TO. HORII	12.07.20	△ 1/1	